

COUPLINGS CATALOG 2025

**NO HUB, FLEXIBLE AND
TRANSITION COUPLINGS AND
ACCESSORIES**



QUICK HUB

-

HEAVY DUTY





-

FLEXIBLE

LIT-044

PICTORIAL INDEX

MIFAB's various coupling products are organized into five different categories. Please contact your local MIFAB representative for the discount structure for each category.

| REGULAR DUTY SHIELDED NO HUB COUPLINGS - MI-HUB SERIES | HEAVY DUTY SHIELDED NO HUB COUPLINGS - MI-XHUB SERIES | REGULAR DUTY QUICK HUB | HEAVY DUTY QUICK HUB |
|---|--|--|--|
|  <p>MI-HUB (Page 6) Discount Structure</p> |  <p>MI-XHUB (Page 7) Discount Structure</p> |  <p>MI-QHUB (Page 8) X = Do not remove the gasket from the shield</p> |  <p>MI-QXHUB (Page 9) X = Do not remove the gasket from the shield</p> |

FLEXIBLE COUPLINGS

| | | | | | | | | | | |
|---|--|--|---|--|--|--|---|---|--|---------------------------|
|  MI-FLEX (Page 14) |  MI-FLEX-CC (Page 15) |  MI-FLEX-CL (Page 15) |  MI-FLEX-CON (Page 16) |  MI-FLEX-SO (Page 16) |  MI-FLEX-CR (Page 17) |  MI-FLEX-CLAY (Page 18) |  MI-FLEX-AH (Page 18) |  MI-FLEX-SOS (Page 18) |  MI-FLEX-DISH (Page 23) | Discount Structure |
|  MI-FLEX-DTC (Page 23) |  C1440-NH (Page 24) |  MI-EC (Page 24) |  C1440-TP (Page 25) |  MI-ELB (Page 26) |  MI-TEE (Page 26) |  MI-EC-HB (Page 27) |  MI-JS (Page 28) |  MI-SCON (Page 28) |  MI-SPF-100 (Page 29) | |

TRANSITION COUPLINGS

| | | | | | | | | | |
|--|--|--|---|---|---|---|--|---|---------------------------|
|  POG-SW (Page 10) |  POG-XSW (Page 11) |  MI-HUB-ARC (Page 12) |  MI-HUB-ARC-CL (Page 12) |  MI-HUB-ARC-DI (Page 13) |  MI-TORQUE (Page 13) |  MI-FLEX-EXP (Page 19) |  MI-HUB-TRS (Page 19) |  MI-HUB-TR (Page 20) | Discount Structure |
|  MI-HUB-TRC (Page 20) |  MI-HUB-TRP (Page 21) |  MI-HUB-TRT (Page 21) |  MI-HUB-TRCC (Page 22) |  MI-HUB-TRTW (Page 22) |  MI-FT (Page 27) |  MI-SEW (Page 29) |  POG-TP (Page 30) | | |

| PIPE MATERIAL | OUTSIDE PIPE DIAMETERS | | | | | | | | | | | |
|---|------------------------|-------------|-------------|-------------|-------------|--------------|--------------|--------------|--------------|--------------|---------------|--------------|
| | 3/4" | 1" | 1 1/4" | 1 1/2" | 2" | 3" | 4" | 5" | 6" | 8" | 10" | 12" |
| ABS / PVC Plastic (Sched. 40) | 1.05" (27) | 1.315" (33) | 1.66" (42) | 1.90" (48) | 2.375" (60) | 3.50" (89) | 4.50" (114) | 5.56" (141) | 6.62" (168) | 8.62" (219) | 10.75" (273) | 12.75" (324) |
| Asbestos Cement (Class 1500 - Transite) | - | - | - | - | - | - | 4.81" (122) | 5.90" (150) | 6.92" (176) | 9.02" (229) | 11.12" (282) | 13.22" (336) |
| Cast Iron | - | - | - | 1.90" (48) | 2.35" (60) | 3.35" (85) | 4.38" (111) | 5.30" (135) | 6.30" (160) | 8.38" (213) | 10.56" (268) | 12.50" (318) |
| Clay | - | - | - | - | - | - | 5.37" (136) | 6.65" (169) | 7.68" (195) | 9.90" (251) | 12.43" (316) | 14.46" (367) |
| Concrete | - | - | - | - | - | - | 6.00" (152) | 6.50" (165) | 8.00" (203) | 10.25" (260) | 12.75" (324) | 15.10" (384) |
| Copper | .875" (22) | 1.125" (29) | 1.375" (35) | 1.625" (41) | 2.125" (54) | 3.125" (79) | 4.125" (105) | 5.125" (130) | 6.125" (156) | 8.125" (206) | 10.125" (257) | - |
| Ductile Iron | - | - | - | - | - | - | 4.80" (122) | - | 6.90" (175) | 9.05" (230) | 11.10" (282) | 13.20" (335) |
| Duriron® | - | - | - | 2.19" (56) | 2.63" (67) | 3.75" (95) | 4.75" (121) | - | 6.69" (170) | - | - | - |
| Extra Heavy Cast Iron | - | - | - | - | 2.38" (60) | 3.50" (89) | 4.50" (114) | 5.50" (140) | 6.50" (165) | 8.62" (219) | 10.75" (273) | 12.75" (324) |
| Stainless Steel | .75" (19) | 1.00" (25) | 1.25" (32) | 1.50" (38) | 2.00" (51) | 3" (76) | 4" (102) | 5" (127) | 6" (152) | 8" (203) | 10" (254) | - |
| Steel | 1.05" (27) | 1.315" (33) | 1.66" (42) | 1.90" (48) | 2.375" (60) | 3.50" (89) | 4.50" (114) | 5.56" (141) | 6.62" (168) | 8.62" (219) | 10.75" (273) | 12.75" (324) |
| Thinwall Plastic PVC (SDR 35) | - | - | - | - | 3.25" (83) | 4.215" (107) | - | 6.27" (159) | 8.40" (213) | 10.50" (267) | - | 12.50" (318) |

"I've been installing hub cast iron for over 25 years and this new MIFAB Quick Hub no hub band is the biggest improvement I have used. It's a labor saver and a must have for any project large or small!!!"

- Forest Powell, General Foreman, Collins Plumbing, San Diego, CA

CALIFORNIA PROPOSITION 65 WARNING. This product contains chemicals known to the State of California to cause cancer and birth defects or other reproductive harm.

TABLE OF CONTENTS

| | DISCOUNT | | DISCOUNT |
|---|-----------------|---|-----------------|
| MI-HUB - List Prices and Cross Reference..... | 6 | MI-FLEX-DTC..... | 23 |
| MI-XHUB - List Prices and Cross Reference..... | 7 | C1440-NH..... | 24 |
| MI-QHUB - List Prices and Cross Reference..... | 8 | MI-EC..... | 24 |
| MI-QXHUB - List Prices and Cross Reference..... | 9 | C1440-TP..... | 25 |
| POG-SW Service Weight Gaskets..... | 10 | MI-ELB..... | 26 |
| POG-XSW..... | 11 | MI-TEE..... | 26 |
| MI-HUB-ARC..... | 12 | MI-FT..... | 27 |
| MI-HUB-ARC-CL..... | 12 | MI-EC-HB..... | 27 |
| MI-HUB-ARC-DI..... | 13 | MI-JS..... | 28 |
| MI-TORQUE (Torque Wrench)..... | 13 | MI-SCON..... | 28 |
| MI-FLEX..... | 14 | MI-SPF-100..... | 29 |
| MI-FLEX-CC..... | 15 | MI-SEW..... | 29 |
| MI-FLEX-CL..... | 15 | POG-TP..... | 30 |
| MI-FLEX-SO..... | 16 | MI-HUB Specification Sheet..... | 31 |
| MI-FLEX-CON..... | 16 | MI-HUB and MI-QHUB Features and Benefits..... | 32 |
| MI-FLEX-CR..... | 17 | MI-HUB and MI-QHUB Installation Instructions..... | 33 |
| MI-FLEX-CLAY..... | 18 | MI-HUB and MI-QHUB - IAPMO Certificate of Listing..... | 34 |
| MI-FLEX-SOS..... | 18 | MI-HUB - CSA Certificate of Compliance..... | 35, 36 |
| MI-FLEX-AH..... | 18 | MI-XHUB Specification Sheet..... | 37 |
| MI-FLEX-EXP..... | 19 | MI-XHUB and MI-QXHUB Features and Benefits..... | 38 |
| MI-HUB-TRS..... | 19 | MI-XHUB and MI-QXHUB Installation Instructions..... | 39 |
| MI-HUB-TR..... | 20 | MI-XHUB and MI-QXHUB - IAPMO Certificate of Listing..... | 40 |
| MI-HUB-TRC..... | 20 | MI-XHUB - FM1680-1989 Test Report..... | 41 |
| MI-HUB-TRP..... | 21 | MI-HUB and MI-QHUB vs. MI-XHUB and MI-QXHUB applications..... | 42 |
| MI-HUB-TRT..... | 21 | Required Use of Hangers and Supports..... | 43 |
| MI-HUB-TRCC..... | 22 | Testing and Inspection of No Hub Couplings..... | 44 |
| MI-HUB-TRTW..... | 22 | Quick Hub No Hub Couplings - Advantages..... | 45 |
| MI-FLEX-DISH..... | 23 | Quick Hub - Time Savings Studies..... | 46 |

"Winsupply of San Diego has been ordering MIFAB MI-HUB no hub couplings for at least the past two years. We find the ordering process simple and smooth and the receiving process seamless and accurate. They have been a pleasure to work with." – David Meinung, Purchasing Manager, WINSUPPLY, San Diego, CA

TERMS AND CONDITIONS

WHOLESALE DISCOUNT: Contact MIFAB® or your local representative for your applicable discount structure.

FREIGHT ALLOWANCE: Ex Works, MIFAB's Chicago, Illinois Factory or Manufacturer Representative's warehouse with full motor freight allowed on shipments of \$3,500.00 Net or more, within the continental U.S.A. or Canada, except Alaska, Hawaii and Puerto Rico. MIFAB® reserves the right to choose the carrier and route of shipment. Alaska: Ex Works, Seattle, WA. Hawaii: Freight allowed on shipments of \$3,500.00 or more only when shipped from West Coast, U.S. Puerto Rico: Ex Works, Miami, Florida. There is no allowance for United Parcel Service, Federal Express or Shipment by air service. Full motor freight is allowed on shipments of \$3,500.00 Net or more, within the continental U.S.A. and Canada for any combination of BEECO, Counterline, No Hub Coupling, Trench Drain, Access Door and Trap Seal Primer products. Shipping dates are estimates and time of delivery is not the essence of the sale of the contract. Therefore, under no circumstances will MIFAB have any responsibility on account of any delays in manufacture, transportation, or otherwise. Additional freight services such as construction site delivery, lift gate delivery service, re-consigned freight or notification charges, are not included in full freight allowance terms, and will result in additional freight charges.

QUOTATION TERMS: List Price and discount protected for 30 days from date issued by MIFAB®. Orders received within this period must be released for shipment within 30 days from date of purchase order, otherwise, prices will be those that are in effect at the time of shipment.

PAYMENT TERMS: Terms of payment are Net 30 days from the date of the invoice. All pricing in United States currency unless sold in Canada in which case Canadian dollars is the currency used. The Buyer shall pay all sales, consumers, and / or any other applicable taxes. Past due accounts will be subject to a 2% per month service charge from the date of the invoice. If any proceedings be instructed by or against Buyer under any bankruptcy or insolvency law, or if Buyer shall fail to make timely payment on this or any other order, or if, in MIFAB's judgment, Buyer's financial situation justifies such action, MIFAB® may, at its election, require payment in advance or cancel the order as to any unshipped item and require payment of its reasonable cancellation charges. If Buyer delays completion of manufacture, MIFAB® may elect to require payment according to percentage of completion. Equipment held for Buyer shall be at Buyer's risk and expense. In all cases, regardless of partial payment, title to the Products shall remain with MIFAB® until payment for the Products (including any notes given therefore) has been made in full. Should legal action be necessary to enforce payment of an unpaid invoice, the Buyer will assume full responsibility for any court costs and reasonable attorney fees. All orders subject to credit check and approval prior to shipment. Confirmed irrevocable letter of credit or cash in advance of shipment is required for accounts without an established line of credit. Minimum invoice amount is \$100.00. MIFAB reserves the right to apply a minimum order charge to equal \$100.00. MIFAB's Accounting Department must be notified of potential pricing errors within 30 days of the invoice date. Any terms and conditions stated on Buyer's orders which are inconsistent with MIFAB's quotation and Terms and Warranties shall be of no effect.

RETURNED GOODS RESTOCKING CHARGE: Standard product may be returned within a one year period only with written permission from MIFAB®. All products in catalog are not considered Standard. Standard product to be determined by MIFAB®. Returned goods are subject to a 25% restocking charge, plus cost of reconditioning, if necessary, to make material saleable. Material must be returned to MIFAB® freight prepaid only after written permission from MIFAB® to accept the returned material. Buyer must provide copy of the original invoice on which the material was charged. The original outgoing freight cost to ship the order will be deducted from the credit. Credit allowance will be in the form of merchandise credit only-not cash credit which must be used within 12 months of the date of issue. The value of a return must total \$100.00 to qualify for credit allowance. No credit will be allowed for discontinued, or made to order items. Products designated non stock and / or that have been specially made are not subject to return or cancellation.

LIMITED WARRANTY: MIFAB® warrants each product against defects in material and workmanship for a period of one year from the date of original shipment. In the event of such defects within the warranty period, MIFAB® will, at its option, replace or recondition the product without charge. This shall constitute the exclusive remedy for breach of warranty, and MIFAB® shall not be responsible for any incidental or consequential damages, including, without limitation, damages or other costs resulting from labor charges, delays, vandalism, negligence, fouling caused by foreign material, damage from adverse water conditions, chemicals, or any other circumstances over which MIFAB® has no control. This warranty shall be invalidated by any abuse, misuse, misapplication or improper installation of the product.

MIFAB MAKES NO OTHER WARRANTIES EXPRESSED OR IMPLIED AS PROVIDED IN THIS LIMITED WARRANTY.

ILLUSTRATIONS OR TYPICAL INSTALLATIONS: The typical installations for various products in each product section are intended to illustrate the products and their options. Under no circumstances are they to be construed as recommended installation procedures. Consult local codes and project specifications for proper installation instructions.

ALL SALES SUBJECT TO MIFAB's TERMS AND WARRANTIES.

NOTE: Prices and terms are subject to change without notice and supersede all previous quotations. The right is reserved to change or modify product design or construction without prior notice and without incurring any obligation to make similar changes and modifications to product previously or subsequently sold. Contact MIFAB® for any clarification.

CONTENTS © MIFAB® INC. Copyright 2025

CALIFORNIA PROPOSITION 65 WARNING. This product contains chemicals known to the State of California to cause cancer and birth defects or other reproductive harm.

Design and dimensions are subject to modification. Prices do not include applicable taxes. Visit www.mifab.com for the most recent product information.

MIFAB®, Inc., 1321 West 119th Street, Chicago, Illinois 60643-5109, USA

Toll Free: 1-800-465-2736, Fax: 1-773-341-3049

All sales subject to MIFAB's Terms and Warranties. Please refer to page 3.

sales@mifab.com • Canada Toll Free: 1-800-387-3880

MIFAB'S SHIELDED TRANSITION COUPLINGS JOIN SIMILAR AND DISSIMILAR PIPE SIZES AND PIPE MATERIALS

Features:

- Rubber sleeve conforms to ASTM Standard C564
- Stainless steel meets ASTM Standard A240M
- All transition couplings use 5/16" hex head screws and tighten to 60 - 80 inch / lbs. torque.
- Corrosion resistant Type 300 Series stainless steel
- Couplings meet and exceed the material and performance requirements of ASTM Standard C1460

Material Guide

- CI = Cast Iron
- K = Copper
- LD = Lead
- PL = Plastic (Sch. 40)
- XH CI = Extra Heavy Cast Iron
- ST = Steel

"We use the MI-HUB and MI-XHUB no hub couplings from MIFAB. No problems, great service and the best price point in the industry. MIFAB no hub couplings are a win-win for us."

– Joe Rooks, Manager, L.A. Plumbing Supply, Duarte, CA

COUPLINGS THAT JOIN CAST IRON PIPE

1 1/2" CAST IRON TO...

| Join | Use Coupling |
|----------------|-----------------|
| 1" Plastic | MI-HUB-TRC-1125 |
| 1" Steel | MI-HUB-TRC-1125 |
| 1 1/4" Copper | MI-HUB-TRC-1125 |
| 1 1/4" Plastic | MI-HUB-TRC-150 |
| 1 1/4" Steel | MI-HUB-TRC-150 |
| 1 1/2" Copper | MI-HUB-TRC-150 |
| 1 1/2" Plastic | MI-HUB-TR-150 |
| 1 1/2" Steel | MI-HUB-TR-150 |
| 1 1/2" Tubular | MI-HUB-TRT-150 |
| 2" Plastic | MI-HUB-TR-215 |
| 2" Steel | MI-HUB-TR-215 |

2" CAST IRON TO...

| Join | Use Coupling |
|------------|-----------------|
| 1" Plastic | MI-HUB-TRC-2125 |

COUPLINGS THAT JOIN COPPER PIPE

1 1/4" COPPER TO...

| Join | Use Coupling |
|------------------|------------------|
| 1 1/4" Plastic | MI-HUB-TRCC-1125 |
| 1 1/2" Copper | MI-HUB-TRCC-1125 |
| 1 1/2" Cast Iron | MI-HUB-TRC-1125 |
| 1 1/2" Plastic | MI-HUB-TRC-1125 |
| 1 1/2" Steel | MI-HUB-TRC-1125 |
| 2" Cast Iron | MI-HUB-TRC-2125 |
| 2" Plastic | MI-HUB-TRC-2125 |
| 2" Steel | MI-HUB-TRC-2125 |

1 1/2" COPPER TO...

| Join | Use Coupling |
|---------------|------------------|
| 1" Plastic | MI-HUB-TRCC-1125 |
| 1" Steel | MI-HUB-TRCC-1125 |
| 1 1/4" Copper | MI-HUB-TRCC-1125 |

COUPLINGS THAT JOIN EXTRA HEAVY CAST IRON PIPE

3" EXTRA HEAVY CAST IRON TO...

| Join | Use Coupling |
|--------------------------|----------------|
| 3" Copper | MI-HUB-TRS-330 |
| 3" Cast Iron | MI-HUB-TR-330 |
| 3" Plastic | MI-HUB-TRP-330 |
| 3" Steel | MI-HUB-TRP-330 |
| 3" Extra Heavy Cast Iron | MI-HUB-TRP-330 |
| 4" Cast Iron | MI-HUB-TR-430 |
| 4" Plastic | MI-HUB-TRP-430 |
| 4" Steel | MI-HUB-TRP-430 |
| 4" Extra Heavy Cast Iron | MI-HUB-TRP-430 |

4" EXTRA HEAVY CAST IRON TO...

| Join | Use Coupling |
|--------------------------|-----------------|
| 3" Plastic | MI-HUB-TRP-430 |
| 3" Steel | MI-HUB-TRP-430 |
| 3" Extra Heavy Cast Iron | MI-HUB-TRP-430 |
| 4" Copper | MI-HUB-TRS-440 |
| 4" Cast Iron | MI-HUB-TR-440 |
| 4" Plastic | MI-HUB-TRP-440 |
| 4" Steel | MI-HUB-TRP-440 |
| 4" Extra Heavy Cast Iron | MI-HUB-TRP-440 |
| 4" Thinwall Plastic | MI-HUB-TRTW-440 |

5" EXTRA HEAVY CAST IRON TO...

| Join | Use Coupling |
|--------------|---------------|
| 5" Cast Iron | MI-HUB-TR-550 |

6" EXTRA HEAVY CAST IRON TO...

| Join | Use Coupling |
|--------------------------|----------------|
| 6" Cast Iron | MI-HUB-TR-660 |
| 6" Plastic | MI-HUB-TRP-660 |
| 6" Steel | MI-HUB-TRP-660 |
| 6" Extra Heavy Cast Iron | MI-HUB-TRP-660 |
| 8" Cast Iron | MI-HUB-TR-880 |

8" EXTRA HEAVY CAST IRON TO...

| Join | Use Coupling |
|--------------|---------------|
| 8" Cast Iron | MI-HUB-TR-880 |

| | |
|----------------|-----------------|
| 1" Steel | MI-HUB-TRC-2125 |
| 1 1/4" Copper | MI-HUB-TRC-2125 |
| 1 1/4" Plastic | MI-HUB-TRC-215 |
| 1 1/4" Steel | MI-HUB-TRC-215 |
| 1 1/2" Copper | MI-HUB-TRC-215 |
| 1 1/2" Plastic | MI-HUB-TR-215 |
| 1 1/2" Steel | MI-HUB-TR-215 |
| 1 1/2" Tubular | MI-HUB-TRT-215 |
| 2" Copper | MI-HUB-TRC-220 |
| 2" Plastic | MI-HUB-TR-200 |
| 2" Steel | MI-HUB-TR-200 |
| 3" Cast Iron | MI-HUB-32 |
| 4" Cast Iron | MI-HUB-42 |

3" CAST IRON TO...

| Join | Use Coupling |
|--------------|----------------|
| 2" Copper | MI-HUB-TRC-320 |
| 2" Cast Iron | MI-HUB-32 |
| 2" Plastic | MI-HUB-32 |
| 2" Steel | MI-HUB-32 |

| | |
|--------------------------|----------------|
| 3" Copper | MI-HUB-TRC-330 |
| 3" Plastic | MI-HUB-TR-330 |
| 3" Steel | MI-HUB-TR-330 |
| 3" Extra Heavy Cast Iron | MI-HUB-TR-330 |
| 4" Cast Iron | MI-HUB-43 |

4" CAST IRON TO...

| Join | Use Coupling |
|--------------------------|----------------|
| 2" Cast Iron | MI-HUB-42 |
| 2" Plastic | MI-HUB-42 |
| 2" Steel | MI-HUB-42 |
| 3" Copper | MI-HUB-TRC-430 |
| 3" Cast Iron | MI-HUB-43 |
| 3" Plastic | MI-HUB-TR-430 |
| 3" Steel | MI-HUB-TR-430 |
| 3" Extra Heavy Cast Iron | MI-HUB-TR-430 |
| 4" Copper | MI-HUB-TRC-440 |
| 4" Plastic | MI-HUB-TR-440 |
| 4" Steel | MI-HUB-TR-440 |
| 4" Extra Heavy Cast Iron | MI-HUB-TR-440 |

3" COPPER TO...

| Join | Use Coupling |
|--------------------------|-----------------|
| 3" Copper | MI-HUB-TRCC-300 |
| 3" Cast Iron | MI-HUB-TRC-330 |
| 3" Plastic | MI-HUB-TRS-330 |
| 3" Steel | MI-HUB-TRS-330 |
| 3" Extra Heavy Cast Iron | MI-HUB-TRS-330 |
| 4" Cast Iron | MI-HUB-TRC-430 |

4" COPPER TO...

| Join | Use Coupling |
|--------------------------|----------------|
| 4" Cast Iron | MI-HUB-TRC-440 |
| 4" Plastic | MI-HUB-TRS-440 |
| 4" Steel | MI-HUB-TRS-440 |
| 4" Extra Heavy Cast Iron | MI-HUB-TRS-440 |

CALIFORNIA PROPOSITION 65 WARNING. This product contains chemicals known to the State of California to cause cancer and birth defects or other reproductive harm.

COUPLINGS THAT JOIN SCHEDULE 40 PLASTIC PIPE (ABS + PVC)

1" PLASTIC TO...

| | |
|------------------|------------------|
| 1 1/4" Plastic | MI-HUB-TRCC-1125 |
| 1 1/4" Steel | MI-HUB-TRCC-1125 |
| 1 1/2" Copper | MI-HUB-TRCC-1125 |
| 1 1/2" Cast Iron | MI-HUB-TRC-1125 |
| 1 1/2" Plastic | MI-HUB-TRC-1125 |
| 1 1/2" Steel | MI-HUB-TRC-1125 |
| 2" Plastic | MI-HUB-TRC-2125 |
| 2" Steel | MI-HUB-TRC-2125 |
| 2" Cast Iron | MI-HUB-TRC-2125 |

1 1/4" PLASTIC TO...

| | |
|------------------|------------------|
| 1" Plastic | MI-HUB-TRCC-1125 |
| 1" Steel | MI-HUB-TRCC-1125 |
| 1" Copper (IPS) | MI-HUB-TRCC-1125 |
| 1 1/4" Copper | MI-HUB-TRCC-1125 |
| 1 1/4" Plastic | MI-HUB-TRCC-150 |
| 1 1/4" Steel | MI-HUB-TRCC-150 |
| 1 1/2" Copper | MI-HUB-TRCC-150 |
| 1 1/2" Cast Iron | MI-HUB-TRC-150 |
| 1 1/2" Plastic | MI-HUB-TRC-150 |
| 1 1/2" Steel | MI-HUB-TRC-150 |

1 1/2" PLASTIC TO...

| | |
|------------------|-----------------|
| 1" Plastic | MI-HUB-TRC-1125 |
| 1" Steel | MI-HUB-TRC-1125 |
| 1 1/4" Copper | MI-HUB-TRC-1125 |
| 1 1/4" Plastic | MI-HUB-TRC-150 |
| 1 1/4" Steel | MI-HUB-TRC-150 |
| 1 1/2" Copper | MI-HUB-TRC-150 |
| 1 1/2" Cast Iron | MI-HUB-TR-150 |
| 1 1/2" Plastic | MI-HUB-TR-150 |
| 1 1/2" Steel | MI-HUB-TR-150 |
| 1 1/2" Tubular | MI-HUB-TRT-150 |
| 2" Cast Iron | MI-HUB-TR-215 |
| 2" Plastic | MI-HUB-TR-215 |
| 2" Steel | MI-HUB-TR-215 |

COUPLINGS THAT JOIN STEEL PIPE

1" STEEL TO...

| | |
|------------------|------------------|
| 1 1/4" Plastic | MI-HUB-TRCC-1125 |
| 1 1/4" Steel | MI-HUB-TRCC-1125 |
| 1 1/2" Copper | MI-HUB-TRCC-1125 |
| 1 1/2" Cast Iron | MI-HUB-TRC-1125 |
| 1 1/2" Plastic | MI-HUB-TRC-1125 |
| 1 1/2" Steel | MI-HUB-TRC-1125 |
| 2" Cast Iron | MI-HUB-TRC-2125 |
| 2" Plastic | MI-HUB-TRC-2125 |
| 2" Steel | MI-HUB-TRC-2125 |

1 1/4" STEEL TO...

| | |
|------------------|------------------|
| 1" Plastic | MI-HUB-TRCC-1125 |
| 1" Steel | MI-HUB-TRCC-1125 |
| 1" Copper (IPS) | MI-HUB-TRCC-1125 |
| 1 1/4" Copper | MI-HUB-TRCC-1125 |
| 1 1/4" Plastic | MI-HUB-TRCC-150 |
| 1 1/4" Steel | MI-HUB-TRCC-150 |
| 1 1/2" Copper | MI-HUB-TRCC-150 |
| 1 1/2" Cast Iron | MI-HUB-TRC-150 |
| 1 1/2" Plastic | MI-HUB-TRC-150 |
| 1 1/2" Steel | MI-HUB-TRC-150 |
| 2" Copper | MI-HUB-TRCC-215 |
| 2" Cast Iron | MI-HUB-TRC-215 |
| 2" Plastic | MI-HUB-TRC-215 |
| 2" Steel | MI-HUB-TRC-215 |

1 1/2" STEEL TO...

| | |
|---------------|-----------------|
| 1" Plastic | MI-HUB-TRC-1125 |
| 1" Steel | MI-HUB-TRC-1125 |
| 1 1/4" Copper | MI-HUB-TRC-1125 |

2" PLASTIC TO...

| | |
|------------------|-----------------|
| 1" Plastic | MI-HUB-TRC-2125 |
| 1" Steel | MI-HUB-TRC-2125 |
| 1" Copper (IPS) | MI-HUB-TRC-2125 |
| 1 1/4" Copper | MI-HUB-TRC-2125 |
| 1 1/4" Plastic | MI-HUB-TRC-215 |
| 1 1/4" Steel | MI-HUB-TRC-215 |
| 1 1/2" Copper | MI-HUB-TRC-215 |
| 1 1/2" Cast Iron | MI-HUB-TR-215 |
| 1 1/2" Plastic | MI-HUB-TR-215 |
| 1 1/2" Steel | MI-HUB-TR-215 |
| 1 1/2" Tubular | MI-HUB-TRT-215 |
| 2" Copper | MI-HUB-TRC-220 |
| 2" Cast Iron | MI-HUB-TR-200 |
| 2" Plastic | MI-HUB-TR-200 |
| 2" Steel | MI-HUB-TR-200 |
| 3" Cast Iron | MI-HUB-32 |
| 4" Cast Iron | MI-HUB-42 |

3" PLASTIC TO

| | |
|--------------------------|----------------|
| 3" Copper | MI-HUB-TRS-330 |
| 3" Cast Iron | MI-HUB-TR-330 |
| 3" Plastic | MI-HUB-TRP-330 |
| 3" Steel | MI-HUB-TRP-330 |
| 3" Extra Heavy Cast Iron | MI-HUB-TRP-330 |
| 4" Cast Iron | MI-HUB-TR-430 |
| 4" Plastic | MI-HUB-TRP-430 |
| 4" Steel | MI-HUB-TRP-430 |
| 4" Extra Heavy Cast Iron | MI-HUB-TRP-430 |

4" PLASTIC TO...

| | |
|--------------------------|-----------------|
| 3" Plastic | MI-HUB-TRP-430 |
| 3" Steel | MI-HUB-TRP-430 |
| 3" Extra Heavy Cast Iron | MI-HUB-TRP-430 |
| 4" Copper | MI-HUB-TRS-440 |
| 4" Cast Iron | MI-HUB-TR-440 |
| 4" Plastic | MI-HUB-TRP-440 |
| 4" Steel | MI-HUB-TRP-440 |
| 4" Extra Heavy Cast Iron | MI-HUB-TRP-440 |
| 4" Thinwall Plastic | MI-HUB-TRTW-440 |

| | |
|----------------|-----------------|
| 1 1/4" Plastic | MI-HUB-TRC-150 |
| 1 1/4" Steel | MI-HUB-TRCC-150 |
| 1 1/2" Copper | MI-HUB-TRC-150 |

1 1/2" STEEL TO...

| | |
|------------------|-----------------|
| 1 1/2" Cast Iron | MI-HUB-TR-150 |
| 1 1/2" Plastic | MI-HUB-TR-150 |
| 1 1/2" Steel | MI-HUB-TR-150 |
| 1 1/2" Tubular | MI-HUB-TRCC-150 |
| 2" Cast Iron | MI-HUB-TR-215 |
| 2" Plastic | MI-HUB-TR-215 |
| 2" Steel | MI-HUB-TR-215 |

2" STEEL TO...

| | |
|------------------|-----------------|
| 1" Plastic | MI-HUB-TRC-2125 |
| 1" Steel | MI-HUB-TRC-2125 |
| 1" Copper (IPS) | MI-HUB-TRC-2125 |
| 1 1/4" Copper | MI-HUB-TRC-2125 |
| 1 1/4" Plastic | MI-HUB-TRC-215 |
| 1 1/4" Steel | MI-HUB-TRC-215 |
| 1 1/2" Copper | MI-HUB-TRC-215 |
| 1 1/2" Cast Iron | MI-HUB-TR-215 |
| 1 1/2" Plastic | MI-HUB-TR-215 |
| 1 1/2" Steel | MI-HUB-TR-215 |
| 1 1/2" Tubular | MI-HUB-TRT-215 |
| 2" Copper | MI-HUB-TRC-220 |
| 2" Cast Iron | MI-HUB-TR-200 |
| 2" Plastic | MI-HUB-TR-200 |
| 2" Steel | MI-HUB-TR-200 |
| 3" Cast Iron | MI-HUB-32 |
| 4" Cast Iron | MI-HUB-42 |

5" PLASTIC TO...

| | |
|--------------|---------------|
| 5" Cast Iron | MI-HUB-TR-550 |
|--------------|---------------|

6" PLASTIC TO...

| | |
|--------------------------|----------------|
| 6" Cast Iron | MI-HUB-TR-660 |
| 6" Plastic | MI-HUB-TRP-660 |
| 6" Steel | MI-HUB-TRP-660 |
| 6" Extra Heavy Cast Iron | MI-HUB-TRP-660 |

8" PLASTIC TO...

| | |
|--------------|---------------|
| 8" Cast Iron | MI-HUB-TR-880 |
|--------------|---------------|

THINWALL PLASTIC PIPE (sewer and drain)

4" THINWALL PLASTIC TO...

| | |
|--------------------------|-----------------|
| Join | Use Coupling |
| 4" Plastic (Sch. 40) | MI-HUB-TRTW-440 |
| 4" Steel | MI-HUB-TRTW-440 |
| 4" Extra Heavy Cast Iron | MI-HUB-TRTW-440 |

COUPLINGS THAT JOIN TUBULAR PIPE

1 1/2" TUBULAR TO...

| | |
|------------------|----------------|
| Join | Use Coupling |
| 1 1/2" Cast Iron | MI-HUB-TRT-150 |
| 1 1/2" Plastic | MI-HUB-TRT-150 |
| 1 1/2" Steel | MI-HUB-TRT-150 |
| 1 1/2" Tubular | MI-HUB-TRT-155 |
| 2" Cast Iron | MI-HUB-TRT-215 |
| 2" Plastic | MI-HUB-TRT-215 |
| 2" Steel | MI-HUB-TRT-215 |

3" STEEL TO...

| | |
|--------------------------|----------------|
| 3" Copper | MI-HUB-TRS-330 |
| 3" Cast Iron | MI-HUB-TR-330 |
| 3" Plastic | MI-HUB-TRP-330 |
| 3" Steel | MI-HUB-TRP-330 |
| 3" Extra Heavy Cast Iron | MI-HUB-TRP-330 |
| 4" Cast Iron | MI-HUB-TR-430 |
| 4" Plastic | MI-HUB-TRP-430 |
| 4" Steel | MI-HUB-TRP-430 |
| 4" Extra Heavy Cast Iron | MI-HUB-TRP-430 |

4" STEEL TO...

| | |
|--------------------------|-----------------|
| 3" Plastic | MI-HUB-TRP-430 |
| 3" Steel | MI-HUB-TRP-430 |
| 3" Extra Heavy Cast Iron | MI-HUB-TRP-430 |
| 4" Copper | MI-HUB-TRS-440 |
| 4" Cast Iron | MI-HUB-TR-440 |
| 4" Plastic | MI-HUB-TRP-440 |
| 4" Steel | MI-HUB-TRP-440 |
| 4" Extra Heavy Cast Iron | MI-HUB-TRP-440 |
| 4" Thinwall Plastic | MI-HUB-TRTW-440 |

5" STEEL TO...

| | |
|--------------|---------------|
| 5" Cast Iron | MI-HUB-TR-550 |
|--------------|---------------|

6" STEEL TO...

| | |
|--------------------------|----------------|
| 6" Cast Iron | MI-HUB-TR-660 |
| 6" Plastic | MI-HUB-TRP-660 |
| 6" Steel | MI-HUB-TRP-660 |
| 6" Extra Heavy Cast Iron | MI-HUB-TRP-660 |

8" STEEL TO...

| | |
|--------------|---------------|
| 8" Cast Iron | MI-HUB-TR-880 |
|--------------|---------------|

CALIFORNIA PROPOSITION 65 WARNING. This product contains chemicals known to the State of California to cause cancer and birth defects or other reproductive harm.

Design and dimensions are subject to modification. Prices do not include applicable taxes. Visit www.mifab.com for the most recent product information.

MIFAB®, Inc., 1321 West 119th Street, Chicago, Illinois 60643-5109, USA

All sales subject to MIFAB's Terms and Warranties. Please refer to page 3.

Toll Free: 1-800-465-2736, Fax: 1-773-341-3049

sales@mifab.com • Canada Toll Free: 1-800-387-3880

MI-HUB REGULAR NO HUB COUPLINGS

Tested and certified to ASTM Standard # C1277, # C1460 and ASTM Standard #C564. Oil Immersion test: 80% Max. Volume. All models are listed with IAPMO and NSF certified to CISPI 310. 5/16" driver required to tighten bolts. Gaskets are made from neoprene.



NOTE: For couplings with two bands, tighten 1-2, couplings with four bands, tighten 2-3-1-4 and couplings with six bands, tighten 3-2-1-4-5-6 alternately until minimum 60 inch lbs. of torque is attained for each band. Tested to ASTM C1277 hydrostatic pressure requirement (see chart below). Tested by I.A.P.M.O. to comply to the CISPI 310, CSA CSA B602 (File # 247608) and B70 Standards. Tested and certified by Intertek Testing Services to CAN/ULC S102.2, "Smoke Test." Stainless Steel Shield and Clamps are made from Type 301 S.S. Bolts are Type 305 Stainless Steel, 5/16" hex head. NSF Certified to the CISPI 310 Standard.

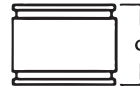

1 1/2" - 8" are tested and certified to the ASTM C1460 Standard. They can be used to connect Cast Iron pipe to Plastic, steel or Extra Heavy Cast Iron pipe.

| MODEL NUMBER | PIPE SIZE | C HEIGHT | INSTALLATION TORQUE (IN. - LBS) | ASTM C1277 HYDROSTATIC PRESSURE REQUIREMENT | NUMBER OF CLAMPS PER COUPLING | CARTON QUANTITY | PALLET QUANTITY | LIST PRICE, Each Piece |
|--------------|-------------|-------------|---------------------------------|---|-------------------------------|-----------------|-----------------|------------------------|
| MI-HUB-150 | 1-1/2" | 2.125" (54) | 60 | 20 psi | 2 | 100 | 3,600 | \$35.95 |
| MI-HUB-2 | 2" | 2.125" (54) | 60 | 20 psi | 2 | 100 | 3,000 | \$35.95 |
| MI-HUB-2150 | 2" x 1-1/2" | 2.125" (54) | 60 | 20 psi | 2 | 100 | 3,000 | \$42.00 |
| MI-HUB-3 | 3" | 2.125" (54) | 60 | 20 psi | 2 | 100 | 1,600 | \$43.25 |
| MI-HUB-32 | 3" x 2" | 2.125" (54) | 60 | 20 psi | 2 | 100 | 1,600 | \$65.50 |
| MI-HUB-4 | 4" | 2.125" (54) | 60 | 20 psi | 2 | 100 | 1,200 | \$51.00 |
| MI-HUB-42 | 4" x 2" | 2.125" (54) | 60 | 20 psi | 2 | 64 | 1,536 | \$93.00 |
| MI-HUB-43 | 4" x 3" | 2.125" (54) | 60 | 20 psi | 2 | 64 | 1,536 | \$78.00 |
| MI-HUB-5 | 5" | 3" (76) | 60 | 20 psi | 4 | 20 | 480 | \$124.25 |
| MI-HUB-6 | 6" | 3" (76) | 60 | 10 psi | 4 | 25 | 300 | \$129.00 |
| MI-HUB-8 | 8" | 4" (102) | 60 | 6 psi | 4 | 15 | 180 | \$244.00 |
| MI-HUB-10 | 10" | 4" (102) | 60 | 6 psi | 4 | 12 | 144 | \$322.00 |
| MI-HUB-12 | 12" | 5.43" (138) | 60 | 6 psi | 6 | 8 | 40 | \$335.25 |
| MI-HUB-15 | 15" | 5.43" (138) | 60 | 6 psi | 6 | 4 | 28 | \$469.25 |

CROSS REFERENCE

| MIFAB | Anaco | Clamp-All | Fernco | Husky | Ideal | Mission | Tyler |
|---------|-------|-------------|--------|--------|-------|---------|-----------|
| MI-HUB | NH | - | NH | - | M8G | C | NH |
| MI-XHUB | - | Hi-Torq 125 | HD | SD4000 | H8G | HW | Wide Body |

"The MIFAB MI-XHUB heavy duty no hub couplings are great and easy to order and they never have had a failure in the field."
 – CD West, Aurora Winnelson, Aurora, CO

CALIFORNIA PROPOSITION 65 WARNING. This product contains chemicals known to the State of California to cause cancer and birth defects or other reproductive harm.

MI-XHUB HEAVY DUTY NO HUB COUPLINGS



ASTM INTERNATIONAL



U.P.C. Approved

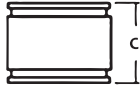

Tested and certified to ASTM Standard # C1540, # C1460 and ASTM Standard #C564. Oil Immersion test: 80% Max. Volume. All models are listed with IAPMO (U.P.C.). 3/8" driver required to tighten bolts. Gaskets are made from neoprene.

NOTE: For couplings with four bands, tighten 2-3-1-4 and couplings with six bands, tighten 3-2-1-4-5-6 alternately until minimum 80 inch lbs. of torque is attained for each band. Tested to ASTM C1540 hydrostatic pressure requirement (see chart below). Tested by I.A.P.M.O. to comply to the FM 1680 (except for markings) and CSA B602 Standards (up to 10"). Per OSHPD Code Application Notice 5-311.9 revised 6/29/2011, signed by Paul Coleman, Section 1 (a) states that: "the use of couplings that have been tested to conform to the performance requirements of FM Approvals, Approval Standard 1680, Class I, by FM Approvals or by a nationally recognized independent testing agency." are acceptable. The MI-XHUB are also tested and certified by Intertek Testing Services to CAN / ULC S102.2 "Smoke Test" Stainless Steel Shield and Clamps are made from Type 304 S.S. Bolts are Type 305 Stainless Steel, 3/8" hex head.



1 1/2" - 8" are tested and certified to the ASTM C1460 Standard. They can be used to connect Cast Iron pipe to Plastic, steel or Extra Heavy Cast Iron pipe.

| MODEL NUMBER | PIPE SIZE | C HEIGHT | INSTALLATION TORQUE (IN. - LBS) | ASTM C1540 HYDROSTATIC PRESSURE REQUIREMENT | NUMBER OF CLAMPS PER COUPLING | CARTON QUANTITY | PALLET QUANTITY | LIST PRICE, Each Piece |
|--------------|-------------|-------------|---------------------------------|---|-------------------------------|-----------------|-----------------|------------------------|
| MI-XHUB-150 | 1-1/2" | 3" (76) | 80 | 30 psi | 4 | 75 | 2,700 | \$26.75 |
| MI-XHUB-2 | 2" | 3" (76) | 80 | 30 psi | 4 | 72 | 1,512 | \$28.50 |
| MI-XHUB-2150 | 2" x 1 1/2" | 3" (76) | 80 | 30 psi | 4 | 72 | 1,512 | \$35.75 |
| MI-XHUB-3 | 3" | 3" (76) | 80 | 30 psi | 4 | 24 | 960 | \$33.00 |
| MI-XHUB-32 | 3" x 2" | 3" (76) | 80 | 30 psi | 4 | 24 | 960 | \$44.00 |
| MI-XHUB-4 | 4" | 3" (76) | 80 | 30 psi | 4 | 24 | 720 | \$38.50 |
| MI-XHUB-42 | 4" x 2" | 3" (76) | 80 | 30 psi | 4 | 24 | 864 | \$61.00 |
| MI-XHUB-43 | 4" x 3" | 3" (76) | 80 | 30 psi | 4 | 24 | 864 | \$52.00 |
| MI-XHUB-5 | 5" | 3" (76) | 80 | 30 psi | 6 | 27 | 324 | \$79.00 |
| MI-XHUB-54 | 5" x 4" | 3" (76) | 80 | 30 psi | 6 | 27 | 324 | \$87.50 |
| MI-XHUB-6 | 6" | 3" (76) | 80 | 27 psi | 6 | 27 | 324 | \$93.50 |
| MI-XHUB-64 | 6" x 4" | 3" (76) | 80 | 27 psi | 6 | 27 | 324 | \$111.25 |
| MI-XHUB-8 | 8" | 4" (102) | 80 | 15 psi | 6 | 15 | 180 | \$184.75 |
| MI-XHUB-10 | 10" | 4" (102) | 80 | 9 psi | 6 | 12 | 120 | \$237.50 |
| MI-XHUB-12 | 12" | 5.43" (138) | 80 | 6 psi | 6 | 5 | 60 | \$303.25 |
| MI-XHUB-15 | 15" | 5.43" (138) | 80 | 6 psi | 6 | 4 | 28 | \$401.50 |

CROSS REFERENCE

| MIFAB | Anaco | Clamp-All | Fernco | Husky | Ideal | Mission | Tyler |
|---------|-------|-------------|--------|--------|-------|---------|-----------|
| MI-HUB | NH | - | NH | - | M8G | C | NH |
| MI-XHUB | - | Hi-Torq 125 | HD | SD4000 | H8G | HW | Wide Body |

CALIFORNIA PROPOSITION 65 WARNING. This product contains chemicals known to the State of California to cause cancer and birth defects or other reproductive harm.

Design and dimensions are subject to modification. Prices do not include applicable taxes. Visit www.mifab.com for the most recent product information.

MIFAB®, Inc., 1321 West 119th Street, Chicago, Illinois 60643-5109, USA

All sales subject to MIFAB's Terms and Warranties. Please refer to page 3.

Toll Free: 1-800-465-2736, Fax: 1-773-341-3049

sales@mifab.com • Canada Toll Free: 1-800-387-3880

MI-QHUB QUICK HUB - REGULAR NO HUB COUPLINGS



X = Do not remove the gasket from the shield

Tested and certified to ASTM Standard # C1277, # C1460 and ASTM Standard # C564. Oil Immersion test: 80% Max. Volume. All models are listed with IAPMO and NSF certified to CISPI 310. 5/16" driver required to tighten bolts. Gaskets are made from neoprene and have three sealing rings.

Note: For couplings with two bands, tighten 1-2, couplings with four bands, tighten 2-3-1-4 and couplings with six bands, tighten 3-2-1-4-5-6 alternately until minimum 60 inch lbs. of torque is attained for each band. Tested to ASTM C1277 hydrostatic pressure requirement (see chart below). Tested by I.A.P.M.O. to comply to the CISPI 310, CSA B602 and B70 Standards. Tested and certified by Intertek Testing Services to CAN/ ULC S102.2 "Smoke Test". Stainless Steel Shield and Clamps are made from Type 301. Stainless Steel bolts are Type 305 Stainless Steel, 5/16" hex head.

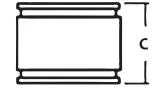

| | | |
|---------------------------------|----------------------------------|---|
| US PATENT #10,100,956 | US PATENT #10,253, 885 | US PATENT #10,557,578 |
| FEATURES | 40% less labor. | Less skilled labor required. |
| | | Faster installation: Complete job quicker to make deadlines. |

ONE AND DONE. Fastest installation on the market. Quick Hub fits easily and effortlessly onto pipe and fittings. With Quick Hub there is no need to remove the gasket from the shield, roll the gasket over the pipe or waste time fumbling with a loose shield. The patented hourglass shape design ensures the gasket remains within the shield during shipping and handling and allows the Quick Hub to be easily pushed onto the pipe.

- 1 1/2" - 8" are tested and certified to the ASTM C1460 Standard. They can be used to connect Cast Iron pipe to Plastic, steel or Extra Heavy Cast Iron pipe.
- 1 1/2" - 6" MI-QHUB models are tested and certified by I.A.P.M.O. R & T to be used to connect PVC / ABS pipe to PVC / ABS pipe.

| MODEL NUMBER | PIPE SIZE | C HEIGHT | INSTALLATION TORQUE (IN. - LBS) | ASTM C1277 HYDROSTATIC PRESSURE REQUIREMENT | NUMBER OF CLAMPS PER COUPLING | CARTON QUANTITY | PALLET QUANTITY | LIST PRICE, Each Piece |
|--------------|-----------|-------------|---------------------------------|---|-------------------------------|-----------------|-----------------|------------------------|
| MI-QHUB-150 | 1-1/2" | 2.125" (54) | 60 | 20 psi | 2 | 100 | 3,600 | \$35.95 |
| MI-QHUB-2 | 2" | 2.125" (54) | 60 | 20 psi | 2 | 100 | 3,000 | \$35.95 |
| MI-QHUB-3 | 3" | 2.125" (54) | 60 | 20 psi | 2 | 100 | 1,600 | \$43.25 |
| MI-QHUB-4 | 4" | 2.125" (54) | 60 | 20 psi | 2 | 100 | 1,200 | \$51.00 |
| MI-QHUB-5 | 5" | 3" (76) | 60 | 20 psi | 4 | 20 | 480 | \$124.25 |
| MI-QHUB-6 | 6" | 3" (76) | 60 | 10 psi | 4 | 25 | 300 | \$129.00 |
| MI-QHUB-8 | 8" | 4" (102) | 60 | 6 psi | 4 | 15 | 180 | \$244.00 |
| MI-QHUB-10 | 10" | 4" (102) | 60 | 6 psi | 4 | 12 | 144 | \$322.00 |
| MI-QHUB-12 | 12" | 5.43" (138) | 60 | 6 psi | 6 | 8 | 40 | \$335.25 |

CROSS REFERENCE

| MIFAB | Anaco | Clamp-All | Fernco | Husky | Ideal | Mission | Tyler |
|----------|-------|-------------|--------|--------|-------|---------|-----------|
| MI-QHUB | NH | - | NH | - | M8G | C | NH |
| MI-QXHUB | - | Hi-Torq 125 | HD | SD4000 | H8G | HW | Wide Body |

"I've been installing hub cast iron for over 25 years and this new MIFAB Quick Hub no hub band is the biggest improvement I have used. It's a labor saver and a must have for any project large or small!!!"

— Forest Powell, General Foreman, Collins Plumbing, San Diego, CA

CALIFORNIA PROPOSITION 65 WARNING. This product contains chemicals known to the State of California to cause cancer and birth defects or other reproductive harm.

MI-QXHUB QUICK HUB - HEAVY DUTY NO HUB COUPLINGS



Tested and certified to ASTM Standard #C1540, #C1460 and ASTM Standard # C564. Oil Immersion test: 80% Max. Volume. All models are listed with IAPMO. 3/8" driver required to tighten bolts. Gaskets are made from neoprene and have three sealing rings.

Note: For couplings with four bands, tighten 2-3-1-4 and couplings with six bands, tighten 3-2-1-4-5-6 alternately until minimum 80 inch lbs. of torque is attained for each band. Tested to ASTM C1540 hydrostatic pressure requirement (see chart below). (20' head pressure.) Tested by I.A.P.M.O. to comply to the FM 1680 (except for markings) and CSA B602 Standards (up to 10"). Per OSHPD Code Application Notice 5-311.9 revised 6/29/2011, signed by Paul Coleman, Section 1 (a) states that: "the use of couplings that have been tested to conform to the performance requirements of FM Approvals, Approval Standard 1680, Class I, by FM Approvals or by a nationally recognized independent testing agency." are acceptable. The MI-QXHUB are also tested and certified by Intertek Testing Services to CAN/ ULC S102.2 "Smoke Test". Stainless Steel Shield and Clamps are made from Type 304. Stainless Steel bolts are Type 305 Stainless Steel, 3/8" hex head.

QuickHub



X = Do not remove the gasket from the shield

FEATURES

40% less labor.

Less skilled labor required.

Faster installation: Complete job quicker to make deadlines.

1 1/2" - 8" are tested and certified to the ASTM C1460 Standard. They can be used to connect Cast Iron pipe to Plastic, steel or Extra Heavy Cast Iron pipe.

| MODEL NUMBER | PIPE SIZE | C HEIGHT | INSTALLATION TORQUE (IN. - LBS) | ASTM C1540 HYDROSTATIC PRESSURE REQUIREMENT | NUMBER OF CLAMPS PER COUPLING | CARTON QUANTITY | PALLET QUANTITY | LIST PRICE, Each Piece |
|--------------|-----------|-------------|---------------------------------|---|-------------------------------|-----------------|-----------------|------------------------|
| MI-QXHUB-150 | 1-1/2" | 3" (76) | 80 | 30 psi | 4 | 75 | 2,700 | \$29.00 |
| MI-QXHUB-2 | 2" | 3" (76) | 80 | 30 psi | 4 | 72 | 1,512 | \$31.00 |
| MI-QXHUB-3 | 3" | 3" (76) | 80 | 30 psi | 4 | 24 | 960 | \$36.00 |
| MI-QXHUB-4 | 4" | 3" (76) | 80 | 30 psi | 4 | 24 | 720 | \$41.75 |
| MI-QXHUB-5 | 5" | 4" (102) | 80 | 30 psi | 6 | 27 | 324 | \$85.75 |
| MI-QXHUB-6 | 6" | 4" (102) | 80 | 27 psi | 6 | 27 | 324 | \$101.50 |
| MI-QXHUB-8 | 8" | 4" (102) | 80 | 15 psi | 6 | 15 | 180 | \$200.50 |
| MI-QXHUB-10 | 10" | 4" (102) | 80 | 9 psi | 6 | 12 | 120 | \$257.75 |
| MI-QXHUB-12 | 12" | 5.43" (138) | 80 | 6 psi | 6 | 5 | 60 | \$329.00 |
| MI-QXHUB-15 | 15" | 5.43" (138) | 80 | 6 psi | 6 | 4 | 28 | \$435.75 |

CROSS REFERENCE

| MIFAB | Anaco | Clamp-All | Fernco | Husky | Ideal | Mission | Tyler |
|----------|-------|-------------|--------|--------|-------|---------|-----------|
| MI-QHUB | NH | - | NH | - | M8G | C | NH |
| MI-QXHUB | - | Hi-Torq 125 | HD | SD4000 | H8G | HW | Wide Body |

CALIFORNIA PROPOSITION 65 WARNING. This product contains chemicals known to the State of California to cause cancer and birth defects or other reproductive harm.

Design and dimensions are subject to modification. Prices do not include applicable taxes. Visit www.mifab.com for the most recent product information.

MIFAB®, Inc., 1321 West 119th Street, Chicago, Illinois 60643-5109, USA

All sales subject to MIFAB's Terms and Warranties. Please refer to page 3.

Toll Free: 1-800-465-2736, Fax: 1-773-341-3049

sales@mifab.com • Canada Toll Free: 1-800-387-3880

POG-SW SERVICE WEIGHT GASKETS

Tested and certified to ASTM Standard # C564. All models are listed with IAPMO. Gaskets are made from neoprene. Their hardness (durometer) is 55, +/- 5. The MIFAB POG Series are a one piece compression gasket. They are used to join hub and spigot cast iron soil pipe and fittings manufactured to the ASTM A 74 Standard.

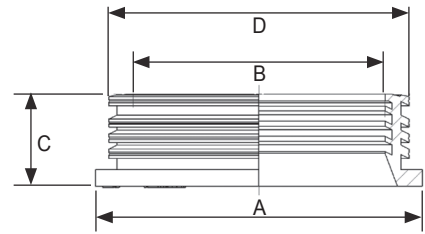

| MODEL NUMBER | PIPE SIZE | CARTON QUANTITY | PALLET QUANTITY | LIST PRICE, Each Piece | MISSION # |
|--------------|-----------|-----------------|-----------------|------------------------|-----------|
| POG-2-SW | 2" | 60 | 2,880 | \$15.25 | SW2 DT |
| POG-3-SW | 3" | 40 | 1,600 | \$20.00 | SW3 DT |
| POG-32-SW | 3" x 2" | 40 | 1,600 | \$17.25 | MR33U 205 |
| POG-4-SW | 4" | 40 | 1,280 | \$25.00 | SW4 DT |
| POG-43-SW | 4" x 3" | 40 | 1,280 | \$18.75 | MR44U 305 |
| POG-5-SW | 5" | 30 | 600 | \$38.00 | SW5 DT |
| POG-6-SW | 6" | 30 | 600 | \$39.25 | SW6 DT |
| POG-8-SW | 8" | 20 | 320 | \$86.00 | SW8 DT |
| POG-10-SW | 10" | 10 | 270 | \$130.75 | SW10 DT |
| POG-12-SW | 12" | 10 | 270 | \$166.50 | SW12 DT |
| POG-15-SW | 15" | 10 | 120 | \$199.00 | SW15 DT |

POG-SW GASKET DIMENSIONS

| | Ø2" | Ø3" | 3"x2" | Ø4" | 4"x3" | Ø5" | Ø6" | Ø8" | Ø10" | Ø12" | Ø15" |
|---|------|------|-------|-------|-------|------|------|-------|-------|-------|-------|
| A | 3.54 | 4.61 | 4.61" | 5.55 | 5.55" | 6.55 | 7.76 | 10.17 | 12.29 | 14.29 | 17.73 |
| B | 2.01 | 3.07 | 2.01" | 4.13 | 3.07" | 5.13 | 5.98 | 8.06 | 10.18 | 12.18 | 15.63 |
| C | 1.85 | 1.85 | 1.85" | 1.91 | 1.91" | 1.91 | 2.18 | 2.68 | 2.68 | 3.43 | 3.43 |
| D | 3.08 | 4.41 | 3.08" | 5.41" | 4.41" | 6.13 | 7.13 | 9.61 | 11.73 | 13.73 | 17.18 |

Typical Service Weight Gasket Installation with Hub and Spigot cast iron pipe.

1. Remove any dirt / debris from both pieces of pipe and inside of the hub.
2. Insert the POG-SW gasket into the hub end of the pipe, apply lubricant to the inside of the gasket.
3. Position the spigot end of the pipe at the opening of the hub.
4. Insert the spigot end of the pipe into the hub end. Ensure the pipe passes through the gasket to firmly seal into the hub end.

CROSS REFERENCE

| MIFAB | Tyler | Charlotte | MISSION | Jones Stephens |
|-------|-----------------|------------------|---------------|-----------------|
| POG | TY-SEAL/EZ TITE | QUIK-TITE/SV 950 | SW2-DUAL TITE | V95- MULTI TITE |

CALIFORNIA PROPOSITION 65 WARNING. This product contains chemicals known to the State of California to cause cancer and birth defects or other reproductive harm.

POG-XSW
SERVICE WEIGHT GASKETS - FOR EXTRA HEAVY DUTY CAST IRON PIPE

Tested and certified to ASTM Standard # C564. All models are listed with I.A.P.M.O. Gaskets are made from neoprene. Their hardness (durometer) is 55 +/-5. The MIFAB POG-XSW Series are a one piece compression gasket. They are used to join extra heavy hub and spigot cast iron soil pipe and fittings manufactured to the ASTM A 74 Standard.

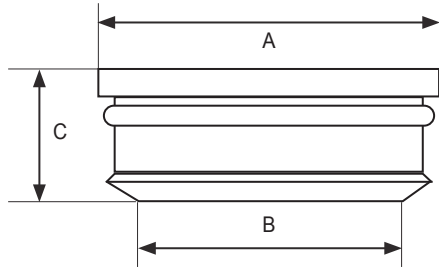

| MODEL NUMBER | PIPE SIZE | CARTON QUANTITY | PALLET QUANTITY | LIST PRICE, Each Piece | MISSION # |
|--------------|-----------|-----------------|-----------------|------------------------|-----------|
| POG-XSW-2 | 2" | 60 | 2,880 | \$21.36 | SW2 XH |
| POG-XSW-3 | 3" | 40 | 1,600 | \$27.95 | SW3 XH |
| POG-XSW-4 | 4" | 40 | 1,280 | \$32.98 | SW4 XH |
| POG-XSW-6 | 6" | 30 | 600 | \$55.91 | SW6 XH |

| POG-XSW GASKET DIMENSIONS | | | | |
|---------------------------|--------------|--------------|--------------|---------------|
| MODEL NUMBER | A inch/mm | B inch/mm | C inch/mm | WEIGHT lbs |
| POG-XSW-2 | 3.85" (98) | 2.25" (57) | 2.0" (51) | 0.25 |
| POG-XSW-3 | 4.65" (118) | 3.35" (85) | 2.25" (57) | 0.40 |
| POG-XSW-4 | 5.70" (145) | 4.45" (113) | 2.25" (57) | 0.50 |
| POG-XSW-6 | 8.12" (206) | 6.30" (146) | 2.25" (57) | 0.85 |

CROSS REFERENCE

| MIFAB | Tyler | Charlotte | MISSION | Jones Stephens |
|-------|-----------------|------------------|---------------|-----------------|
| POG | TY-SEAL/EZ TITE | QUIK-TITE/SV 950 | SW2-DUAL TITE | V95- MULTI TITE |

CALIFORNIA PROPOSITION 65 WARNING. This product contains chemicals known to the State of California to cause cancer and birth defects or other reproductive harm.

Design and dimensions are subject to modification. Prices do not include applicable taxes. Visit www.mifab.com for the most recent product information.

MIFAB®, Inc., 1321 West 119th Street, Chicago, Illinois 60643-5109, USA
All sales subject to MIFAB®'s Terms and Warranties. Please refer to page 3.

Toll Free: 1-800-465-2736, Fax: 1-773-341-3049
sales@mifab.com • Canada Toll Free: 1-800-387-3880

MI-HUB-ARC-DI SHIELDED REPAIR COUPLINGS - ASBESTOS CEMENT OR DUCTILE IRON TO CAST IRON OR PLASTIC

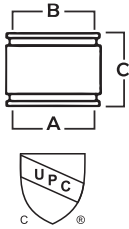

MIFAB's MI-HUB-ARC-DI Series of shielded repair couplings are engineered for resistance to heavy earth loads and shear forces and also provide improved pipe alignment. For asbestos cement or ductile iron pipe to cast iron or plastic pipe.

Note: For couplings with two bands, tighten 1-2, couplings with four bands, tighten 2-3-1-4 and couplings with six bands, tighten 3-2-1-4-5-6 alternately until minimum 60 inch lbs. of torque is attained for each band. Tested to maintain 4.3 p.s.i. maximum line pressure (10' head pressure) Tested and Certified to ASTM Standard #C1173. All models are listed with I.A.P.M.O. (U.P.C.) 5/16" driver required to tighten bolts. All models are listed to the National Plumbing Code of Canada and relevant Canadian Standard(s) and bear the cUPC mark of conformity. All models are manufactured in compliance with ASTM #C1173 and CSA B602 Standards. Non constant temperature rating is 140 F. Stainless Steel Clamps and 5/16" hex head bolts are made from Type 300 Stainless Steel.



| MODEL NUMBER | PIPE SIZE | A WIDTH | B WIDTH | C HEIGHT | CARTON QUANTITY | PALLET QUANTITY | LIST PRICE, Each Piece |
|------------------|---|-------------|-------------|-------------|-----------------|-----------------|------------------------|
| MI-HUB-ARC-DI-88 | 8" ASBESTOS CEMENT / DUCTILE IRON TO 8" CI / PL | 8.64" (219) | 8.64" (219) | 6.04" (153) | 10 | 100 | \$125.00 |

CROSS REFERENCE

| MIFAB | ANACO | FERNCO | HUSKY | MISSION | PASCO |
|------------------|-------|--------|-------|-------------|-------|
| MI-HUB-ARC-DI-88 | - | - | - | MR 51 88ARC | - |

MI-TORQUE TORQUE WRENCH 60 IN. - LBS.

SPECIFICATION: MIFAB® MI-TORQUE black handled 60 in. – lbs. steel torque wrench with 5/16" hex drive.

FUNCTION: The MI-TORQUE wrench is used to tighten MIFAB's MI-HUB Series of regular duty no hub couplings and any other brand of regular duty no hub couplings to 60 inch lbs. in order to connect No Hub soil pipe. The MI-TORQUE wrench tightens with a ratchet action and slips at the 60 inch lbs. preset torque limit to avoid over tightening. The T-shaped handle provides good leverage for the operator and fast and easy one - handed tightening in the right hand direction.

MI-TORQUE
List Price - \$77.00

CROSS REFERENCE

| MIFAB | Wheeler Rex | Ideal | Lowell | Ridgid |
|-----------|-------------|--------|--------|--------|
| MI-TORQUE | 1967 | 8-9995 | 3T000 | 902 |



"MIFAB commercial plumbing products have you covered so nothing you need slips through your hands."
Richard Aliff, BNK Engineering, Raleigh, NC

CALIFORNIA PROPOSITION 65 WARNING. This product contains chemicals known to the State of California to cause cancer and birth defects or other reproductive harm.

Design and dimensions are subject to modification. Prices do not include applicable taxes. Visit www.mifab.com for the most recent product information.

MIFAB®, Inc., 1321 West 119th Street, Chicago, Illinois 60643-5109, USA
All sales subject to MIFAB's Terms and Warranties. Please refer to page 3.

Toll Free: 1-800-465-2736, Fax: 1-773-341-3049
sales@mifab.com • Canada Toll Free: 1-800-387-3880

MI-FLEX FLEXIBLE COUPLINGS CI, PL, ST OR LD TO CI, PL, ST, OR LD



MIFAB's MI-FLEX Series of flexible rubber couplings are used to connect cast iron, plastic, steel or lead pipe to cast iron, plastic, steel or lead pipe.

Note: For couplings with two bands, tighten 1-2, alternately until minimum 60 inch lbs. of torque is attained for each band. Tested to maintain 4.3 p.s.i. maximum line pressure (10' head pressure) Tested and Certified to ASTM Standard #C1173. All models are listed with I.A.P.M.O. (U.P.C.) 5/16" driver required to tighten bolts. All models are listed to the National Plumbing Code of Canada and relevant Canadian Standard(s) and bear the cUPC mark of conformity. All models are manufactured in compliance with ASTM #C1173 and CSA B602 Standards. Non constant temperature rating is 140 F. Stainless Steel Clamps and 5/16" hex head bolts are made from Type 300 Stainless Steel.

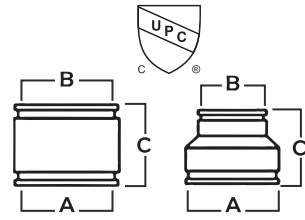

| MODEL NUMBER | PIPE SIZE | A | | B | | C HEIGHT | CARTON QUANTITY | PALLET QUANTITY | LIST PRICE, Each Piece |
|---------------|---|--------------|--------------|--------------|--------------|-------------|-----------------|-----------------|------------------------|
| | | MIN | MAX | MIN | MAX | | | | |
| MI-FLEX-075 | 3/4" Tubing / Copper or 1 1/4" PL / ST / LD x 3/4" PL / ST / LD Flex coupling | 1.05" (27) | 1.45" (36) | 1.05" (27) | 1.45" (36) | 2.23" (56) | 100 | 4,500 | \$11.75 |
| MI-FLEX-100 | 1" Tubing / Copper or 1 1/4" PL / ST / LD x 1" PL / ST / LD Flex coupling | 1.31" (33) | 1.72" (44) | 1.31" (33) | 1.72" (44) | 2.38 (60) | 100 | 4,500 | \$13.50 |
| MI-FLEX-125 | 1 1/2" Tubing / Copper or 1 1/4" PL / ST / LD x 1 1/4" PL / ST / LD Flex coupling | 1.42" (36) | 1.69" (43) | 1.42" (36) | 1.69" (43) | 3.50" (89) | 100 | 4,500 | \$14.00 |
| MI-FLEX-15125 | 1 1/2" CI / PL / ST / LD x 1 1/2" Tubing, Copper or 1 1/4" PL / ST / LD Flex coupling | 1.73" (44) | 1.97" (50) | 1.34" (34) | 1.69" (43) | 3.50" (89) | 100 | 4,500 | \$15.75 |
| MI-FLEX-150 | 1 1/2" CI / PL / ST / LD x 1 1/2" CI / PL / ST / LD Flex coupling | 1.73" (44) | 2" (52) | 1.73" (44) | 2" (52) | 3.50" (89) | 100 | 4,500 | \$15.25 |
| MI-FLEX-200 | 2" CI / PL / ST / LD x 2" CI / PL / ST / LD Flex coupling | 2.20" (56) | 2.50" (64) | 2.20" (56) | 2.50" (64) | 3.50" (89) | 100 | 2,200 | \$17.00 |
| MI-FLEX-215 | 2" CI / PL / ST / LD x 1 1/2" CI / PL / ST / LD Flex coupling | 2.13" (54) | 2.50" (64) | 1.70" (43) | 1.97" (50) | 3.50" (89) | 100 | 3,200 | \$18.00 |
| MI-FLEX-300 | 3" CI / PL / ST / LD x 3" CI / PL / ST / LD Flex coupling | 2.60" (66) | 3.18" (81) | 2.60" (66) | 3.18" (81) | 2.75" (70) | 80 | 1,920 | \$22.75 |
| MI-FLEX-315 | 3" CI / PL / ST / LD x 1 1/2" CI / PL / ST / LD Flex coupling | 3.35" (85) | 3.96" (101) | 1.91" (49) | 2.49" (63) | 4" (102) | 90 | 2,160 | \$27.50 |
| MI-FLEX-320 | 3" CI / PL / ST / LD x 2" CI / PL / ST / LD Flex coupling | 2.60" (66) | 3.18" (81) | 2.20" (56) | 2.50" (64) | 2.75" (70) | 90 | 2,160 | \$21.50 |
| MI-FLEX-400 | 4" CI / PL / ST / LD x 4" CI / PL / ST / LD Flex coupling | 4.02" (102) | 4.65" (118) | 4.02" (102) | 4.65" (118) | 4" (102) | 60 | 1,320 | \$28.75 |
| MI-FLEX-415 | 4" CI / PL / ST / LD x 1 1/2" CI / PL / ST / LD Flex coupling | 4.02" (102) | 4.50" (114) | 1.73" (44) | 1.97" (50) | 4" (102) | 60 | 1,800 | \$42.25 |
| MI-FLEX-420 | 4" CI / PL / ST / LD x 2" CI / PL / ST / LD Flex coupling | 4.02" (102) | 4.50" (114) | 2.20" (56) | 2.50" (64) | 4" (102) | 60 | 1,800 | \$39.75 |
| MI-FLEX-430 | 4" CI / PL / ST / LD x 3" CI / PL / ST / LD Flex coupling | 4.02" (102) | 4.50" (114) | 2.60" (66) | 3.18" (81) | 4" (102) | 60 | 1,440 | \$30.25 |
| MI-FLEX-500 | 5" CI / PL / ST / LD x 5" CI / PL / ST / LD Flex coupling | 5.20" (132) | 5.70" (145) | 5.20" (132) | 5.70" (145) | 4" (102) | 30 | 720 | \$46.75 |
| MI-FLEX-540 | 5" CI / PL / ST / LD x 4" CI / PL / ST / LD Flex coupling | 5.25" (133) | 5.66" (144) | 3.87" (98) | 4.33" (110) | 4" (102) | 30 | 720 | \$52.50 |
| MI-FLEX-600 | 6" CI / PL / ST / LD x 6" CI / PL / ST / LD Flex coupling | 6.30" (160) | 6.69" (170) | 6.30" (160) | 6.69" (170) | 6" (152) | 18 | 432 | \$61.00 |
| MI-FLEX-640 | 6" CI / PL / ST / LD x 4" CI / PL / ST / LD Flex coupling | 6.29" (160) | 6.75" (171) | 4.08" (104) | 4.55" (116) | 5.75" (146) | 30 | 720 | \$71.50 |
| MI-FLEX-650 | 6" CI / PL / ST / LD x 5" CI / PL / ST / LD Flex coupling | 5.97" (152) | 6.54" (166) | 5.15" (131) | 5.65" (144) | 5.75" (146) | 30 | 720 | \$73.50 |
| MI-FLEX-800 | 8" CI / PL / ST / LD x 8" CI / PL / ST / LD Flex coupling | 8" (203) | 8.74" (222) | 8" (203) | 8.74" (222) | 6" (152) | 10 | 240 | \$95.00 |
| MI-FLEX-840 | 8" CI / PL / ST / LD x 4" CI / PL / ST / LD Flex coupling | 8" (203) | 8.74" (222) | 4.02" (102) | 4.65" (118) | 6" (152) | 10 | 240 | \$150.00 |
| MI-FLEX-860 | 8" CI / PL / ST / LD x 6" CI / PL / ST / LD Flex coupling | 8.05" (204) | 8.60" (218) | 5.85" (149) | 6.38" (162) | 6" (152) | 10 | 240 | \$109.75 |
| MI-FLEX-1000 | 10" CI / PL / ST / LD x 10" CI / PL / ST / LD Flex coupling | 10.10" (257) | 10.78" (274) | 10.24" (260) | 10.78" (274) | 6" (152) | 8 | 192 | \$136.00 |
| MI-FLEX-1008 | 10" CI / PL / ST / LD x 8" CI / PL / ST / LD Flex coupling | 9.60" (244) | 10.40" (264) | 7.75" (197) | 8.56" (217) | 6" (152) | 8 | 192 | \$149.50 |
| MI-FLEX-1200 | 12" CI / PL / ST / LD x 12" CI / PL / ST / LD Flex coupling | 12.05" (306) | 12.65" (321) | 12.05" (306) | 12.65" (321) | 6" (152) | 4 | 44 | \$159.50 |

CROSS REFERENCE

| MIFAB | ANACO | FERNCO | HUSKY | MISSION | PASCO |
|---------------|-------|------------|-------|-------------|---------|
| MI-FLEX-075 | - | 1056-075 | - | MR 56 075 | 56075 |
| MI-FLEX-125 | - | 1056-125 | - | MR56 100 | 56100 |
| MI-FLEX-125 | - | 1056-125 | - | MR 56 125 | 56125 |
| MI-FLEX-15125 | - | 1056-15125 | - | MR 56 15125 | 5615125 |
| MI-FLEX-150 | 6011 | 1056-150 | 6011 | MR 56 15 | 5615 |
| MI-FLEX-200 | 6023 | 1056-22 | 6023 | MR 56 22 | 5622 |
| MI-FLEX-215 | 6021 | 1056-215 | 6021 | MR 56 215 | 56215 |
| MI-FLEX-300 | 6035 | 1056-33 | 6035 | MR 56 33 | 5633 |
| MI-FLEX-315 | - | 1056-315 | - | MR 56 315 | 56315 |
| MI-FLEX-320 | 6033 | 1056-32 | 6033 | MR 56 32 | 5632 |
| MI-FLEX-400 | 6043 | 1056-44 | 6043 | MR 56 44 | 5644 |
| MI-FLEX-415 | - | 1056-415 | - | MR 56 415 | 56415 |
| MI-FLEX-420 | 6040 | 1056-42 | 6040 | MR 56 42 | 5642 |
| MI-FLEX-430 | 6041 | 1056-43 | 6041 | MR 56 43 | 5643 |
| MI-FLEX-500 | - | 1056-55 | - | MR 56 55 | 5655 |
| MI-FLEX-540 | - | 1056-540 | - | MR 56 54 | 5654 |
| MI-FLEX-600 | - | 1056-66 | - | MR 56 66 | 5666 |
| MI-FLEX-640 | - | 1056-64 | - | MR 56 64 | 5664 |
| MI-FLEX-650 | - | 1056-65 | - | MR 56 65 | 5665 |
| MI-FLEX-800 | - | 1056-88 | - | MR 56 88 | 5688 |
| MI-FLEX-840 | - | 1056-84 | - | MR 56 84 | 5684 |
| MI-FLEX-860 | - | 1056-86 | - | MR 56 86 | 5686 |
| MI-FLEX-1000 | - | 1056-1010 | - | MR 56 1010 | 561010 |
| MI-FLEX-1008 | - | 1056-1008 | - | MR 56 1008 | 561008 |
| MI-FLEX-1200 | - | 1056-1212 | - | MR 56 1212 | 561212 |

CALIFORNIA PROPOSITION 65 WARNING. This product contains chemicals known to the State of California to cause cancer and birth defects or other reproductive harm.

MI-FLEX-CC FLEXIBLE COUPLINGS - CONCRETE TO CI, PLASTIC, COPPER, STEEL OR LEAD

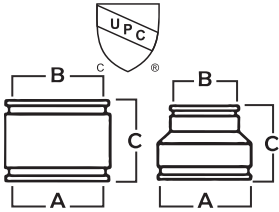

MIFAB's MI-FLEX-CC Series of flexible rubber couplings are used to connect concrete pipe to cast iron, plastic, copper steel or lead pipe.

Note: For couplings with two bands, tighten 1-2, alternately until minimum 60 inch lbs. of torque is attained for each band. Tested to maintain 4.3 p.s.i. maximum line pressure (10' head pressure). Tested and Certified to ASTM Standard #C1173. All models are listed with I.A.P.M.O. (U.P.C.). 5/16" driver required to tighten bolts. All models are listed to the National Plumbing Code of Canada and relevant Canadian Standard(s) and bear the cUPC mark of conformity. All models are manufactured in compliance with ASTM #C1173. Non constant temperature rating is 140 F. Stainless Steel Clamps and 5/16" hex head bolts are made from Type 300 Stainless Steel.



"We might be a small outfit but we still know quality. MIFAB's couplings are high quality - they always have been."
 - Malcolm Enos, Denos Plumbing & Heating, Markham, Ontario, Canada

| MODEL NUMBER | PIPE SIZE | A | | B | | C HEIGHT | CARTON QUANTITY | PALLET QUANTITY | LIST PRICE, Each Piece |
|-----------------|-------------------------------------|--------------|--------------|--------------|--------------|-------------|-----------------|-----------------|------------------------|
| | | MIN | MAX | MIN | MAX | | | | |
| MI-FLEX-CC-400 | 4" Concrete x 4" CI / PL coupling | 5.56" (141) | 6.27" (159) | 4.30" (109) | 5.02" (128) | 3.95" (100) | 60 | 1,200 | \$30.00 |
| MI-FLEX-CC-430 | 4" Concrete x 3" CI/PL coupling | 5.56" (141) | 6.22 (158) | 3.53 (90) | 4.20" (107) | 3.90" (99) | 60 | 1,200 | \$35.50 |
| MI-FLEX-CC-600 | 6" Concrete x 6" CI / PL coupling | 7.78" (197) | 8.49" (215) | 6.38" (162) | 7.10" (180) | 5.81" (148) | 20 | 400 | \$65.50 |
| MI-FLEX-CC-640 | 6" Concrete x 4" CI / PL coupling | 7.75" (197) | 8.55" (217) | 4.31" (109) | 5.10" (130) | 5.91" (150) | 20 | 500 | \$69.50 |
| MI-FLEX-CC-800 | 8" Concrete x 8" CI / PL coupling | 10" (254) | 10.50" (267) | 8.12" (206) | 8.40" (213) | 6" (152) | 8 | 150 | \$95.00 |
| MI-FLEX-CC-1212 | 12" Concrete x 12" CI / PL coupling | 16.28" (414) | 17.41" (442) | 12.38" (314) | 13.43" (341) | 6.30" (160) | 4 | - | \$152.00 |

CROSS REFERENCE

| MIFAB | ANACO | FERNCO | HUSKY | MISSION | PASCO |
|-----------------|-------|-----------|-------|------------|--------|
| MI-FLEX-CC-400 | - | 1006-44 | - | MR 06 44 | 56644 |
| MI-FLEX-CC-430 | - | 1006-43 | - | MR 06 43 | 56643 |
| MI-FLEX-CC-600 | - | 1006-66 | - | MR 06 66 | 56666 |
| MI-FLEX-CC-640 | - | 1006-64 | - | MR 06 64 | 56664 |
| MI-FLEX-CC-800 | - | 1006-88 | - | MR 06 88 | 56688 |
| MI-FLEX-CC-1212 | - | 1006-1212 | - | MR 06 1212 | 561212 |

MI-FLEX-CL FLEXIBLE COUPLINGS - CLAY TO CI OR PLASTIC

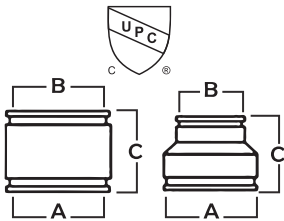

MIFAB's MI-FLEX-CL Series of flexible rubber couplings are used to connect clay pipe to cast iron or plastic pipe.

Note: For couplings with two bands, tighten 1-2, alternately until minimum 60 inch lbs. of torque is attained for each band. Tested to maintain 4.3 p.s.i. maximum line pressure (10' head pressure) Tested and Certified to ASTM Standard #C1173. All models are listed with I.A.P.M.O. (U.P.C.). 5/16" driver required to tighten bolts. All models are listed to the National Plumbing Code of Canada and relevant Canadian Standard(s) and bear the cUPC mark of conformity. All models are manufactured in compliance with ASTM #C1173 and CSA B602 Standards. Non constant temperature rating is 140 F. Stainless Steel Clamps & 5/16" hex head bolts are made from Type 300 Stainless Steel.



| MODEL NUMBER | PIPE SIZE | A | | B | | C HEIGHT | CARTON QUANTITY | PALLET QUANTITY | LIST PRICE, Each Piece |
|-----------------|--|--------------|--------------|--------------|--------------|--------------|-----------------|-----------------|------------------------|
| | | MIN | MAX | MIN | MAX | | | | |
| MI-FLEX-CL-400 | 4" Clay x 4" CI / PL Flexible coupling | 4.75" (121) | 5.38" (137) | 4" (102) | 4.63" (118) | 4" (102) | 60 | 1,200 | \$27.75 |
| MI-FLEX-CL-430 | 4" Clay x 3" CI/PL Flexible coupling | 5.25" (133) | 5.85" (149) | 3.38" (86) | 3.98" (101) | 4" (102) | 60 | 600 | \$30.75 |
| MI-FLEX-CL-500 | 5" Clay x 5" CI / PL Flexible coupling | 5.61" (142) | 6.20" (157) | 5.15" (131) | 5.65" (144) | 5" (127) | 30 | 360 | \$46.75 |
| MI-FLEX-CL-640 | 6" Clay x 4" CI / PL Flexible coupling | 7" (178) | 7.56" (192) | 3.87" (98) | 4.41" (112) | 5 1/2" (140) | 20 | 500 | \$69.50 |
| MI-FLEX-CL-600 | 6" Clay x 6" CI / PL Flexible coupling | 7.05" (179) | 7.56" (192) | 6.15" (156) | 6.69" (170) | 6" (152) | 20 | 400 | \$59.50 |
| MI-FLEX-CL-860 | 8" Clay x 6" CI / PL Flexible coupling | 8.80" (224) | 9.43" (240) | 5.90" (150) | 6.31" (160) | 6" (152) | 8 | 192 | \$113.00 |
| MI-FLEX-CL-800 | 8" Clay x 8" CI / PL Flexible coupling | 9.10" (231) | 9.90" (251) | 7.87" (200) | 8.75" (222) | 6" (152) | 8 | 192 | \$91.00 |
| MI-FLEX-CL-1000 | 10" Clay x 10" CI / PL Flexible coupling | 11.75" (298) | 12.70" (323) | 9.75" (248) | 10.75" (273) | 5.75" (146) | 8 | 88 | \$136.25 |
| MI-FLEX-CL-1212 | 12" Clay x 12" CI / PL Flexible coupling | 14.50" (368) | 15.50" (394) | 12.50" (318) | 13.50" (343) | 6.50" (165) | 8 | 88 | \$152.00 |
| MI-FLEX-CL-1515 | 15" Clay x 15" CI / PL Flexible coupling | 18.14" (461) | 19.28" (490) | 15.60" (396) | 16.60" (422) | 6.86" (174) | 4 | 10 | \$194.50 |
| MI-FLEX-CC-800 | 8" Concrete x 8" CI / PL coupling | 10" (254) | 10.50" (267) | 8.12" (206) | 8.40" (213) | 6" (152) | 8 | 150 | \$95.00 |

CROSS REFERENCE

| MIFAB | ANACO | FERNCO | HUSKY | MISSION | PASCO |
|-----------------|-------|-----------|-------|------------|---------|
| MI-FLEX-CL-400 | - | 1002-44 | - | MR 02 44 | 56244 |
| MI-FLEX-CL-430 | - | 1002-43 | - | MR 02 43 | 56243 |
| MI-FLEX-CL-500 | - | 1002-55 | - | MR 02 55 | - |
| MI-FLEX-CL-640 | - | 1002-64 | - | MR 02 64 | 56264 |
| MI-FLEX-CL-600 | - | 1002-66 | - | MR 02 66 | 56266 |
| MI-FLEX-CL-860 | - | 1002-86 | - | MR 02 86 | - |
| MI-FLEX-CL-800 | - | 1002-88 | - | MR 02 88 | 56288 |
| MI-FLEX-CL-1000 | - | 1002-1010 | - | MR 02 1010 | 5621010 |
| MI-FLEX-CL-1212 | - | 1002-1212 | - | MR 02 1212 | 5621212 |
| MI-FLEX-CL-1515 | - | 1002-1515 | - | MR 02 1515 | - |

CALIFORNIA PROPOSITION 65 WARNING. This product contains chemicals known to the State of California to cause cancer and birth defects or other reproductive harm.

Design and dimensions are subject to modification. Prices do not include applicable taxes. Visit www.mifab.com for the most recent product information.

MIFAB®, Inc., 1321 West 119th Street, Chicago, Illinois 60643-5109, USA

Toll Free: 1-800-465-2736, Fax: 1-773-341-3049

All sales subject to MIFAB's Terms and Warranties. Please refer to page 3.

sales@mifab.com • Canada Toll Free: 1-800-387-3880

MI-FLEX-CON FLEXIBLE COUPLINGS - PLASTIC SOCKET TO PL / CI

MIFAB's MI-FLEX-CON Series of couplings are used to connect asbestos cement or Ductile Iron pipe to Cast Iron or Schedule 40 Plastic pipe.

Note: For couplings with two bands, tighten 1-2, alternately until minimum 60 inch lbs. of torque is attained for each band. Tested to maintain 4.3 p.s.i. maximum line pressure (10' head pressure). Conforms to ASTM Standard #C1173.

Non constant temperature rating is 140 degrees F. Stainless Steel Clamp and 5/16" hex head bolt are made from Type 300 Stainless Steel. For non-pressure, gravity flow applications only. Underground installations.

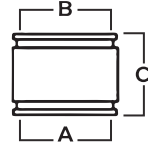

| MODEL NUMBER | PIPE SIZE | A | | B | | C HEIGHT | CARTON QUANTITY | PALLET QUANTITY | LIST PRICE, Each Piece |
|----------------|-----------------------|----------------|----------------|----------------|----------------|----------|-----------------|-----------------|------------------------|
| | | MIN | MAX | MIN | MAX | | | | |
| MI-FLEX-CON-44 | 4" AC/DI x 4" CI / PL | 4.80" (122) | 5.52" (140) | 4.40" (112) | 5.13" (130) | 4" (102) | 20 | 500 | \$30.00 |

CROSS REFERENCE

| MIFAB | ANACO | FERNCO | HUSKY | MISSION | PASCO |
|----------------|-------|---------|-------|---------|--------|
| MI-FLEX-CON-44 | - | 1051-44 | - | MR 51 | 565144 |

MI-FLEX-SO FLEXIBLE COUPLINGS - PLASTIC SOCKET TO PL / CI

MIFAB's MI-FLEX-SO Series of couplings are used to connect plastic socket to plastic and / or C.I. pipe.

Note: For couplings with two bands, tighten 1-2, alternately until minimum 60 inch lbs. of torque is attained for each band. Tested to maintain 4.3 p.s.i. maximum line pressure (10' head pressure). Conforms to ASTM Standard #C1173.

Non constant temperature rating is 140 degrees F. Stainless Steel Clamp and 5/16" hex head bolt are made from Type 300 Stainless Steel.

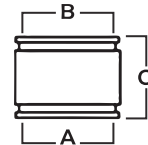

| MODEL NUMBER | PIPE SIZE | A | | B | | C HEIGHT | CARTON QUANTITY | PALLET QUANTITY | LIST PRICE, Each Piece |
|----------------|--|----------------|----------------|----------------|----------------|-------------|-----------------|-----------------|------------------------|
| | | MIN | MAX | MIN | MAX | | | | |
| MI-FLEX-SO-150 | 1 1/2" PLASTIC SOCKET x 1 1/2" PLASTIC /CI | 2.25" (57) | 1.97" (50) | 3.90" (99) | 2.56" (65) | 3.90" (99) | 100 | 4,500 | \$11.75 |
| MI-FLEX-SO-2 | 2" PLASTIC SOCKET x 2" PLASTIC /CI | 2.70" (69) | 2.40" (61) | 3.90" (99) | 2.99" (76) | 3.90" (99) | 100 | 4,500 | \$13.50 |
| MI-FLEX-SO-3 | 3" PLASTIC SOCKET x 3" PLASTIC /CI | 3.99" (101) | 3.49" (89) | 3.99" (101) | 4.26" (108) | 3.99" (101) | 80 | 4,500 | \$14.00 |
| MI-FLEX-SO-4 | 4 1/2" PLASTIC SOCKET x 4" PLASTIC /CI | 5.01" (127) | 4.50" (114) | 3.99" (101) | 5.29" (134) | 3.99" (101) | 60 | 4,500 | \$15.75 |

CROSS REFERENCE

| MIFAB | ANACO | FERNCO | HUSKY | MISSION | PASCO |
|----------------|-------|----------|-------|---------|-------|
| MI-FLEX-SO-150 | - | 1059-150 | - | - | 59150 |
| MI-FLEX-SO-2 | - | 1059-22 | - | - | 5922 |
| MI-FLEX-SO-3 | - | 1059-33 | - | - | 5933 |
| MI-FLEX-SO-4 | - | 1059-44 | - | - | 5944 |

CALIFORNIA PROPOSITION 65 WARNING. This product contains chemicals known to the State of California to cause cancer and birth defects or other reproductive harm.

MI-FLEX-CR FLEXIBLE COUPLINGS – SLIP ON

MIFAB's MI-FLEX-CR Series of slip on couplings are used to connect various types of piping materials and diameters for a drain, waste and vent (DWV) system.

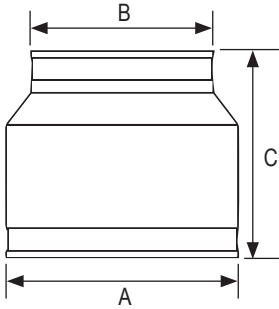

Note: For couplings with two bands, tighten 1-2, alternately until minimum 60 inch lbs. of torque is attained for each band. Tested to maintain 4.3 p.s.i. maximum line pressure (10' head pressure). All models conform to the National Plumbing Code of Canada, ASTM C1440, C1461, C-564 and CSA B602 Standards. Non constant temperature rating is 140 F. Stainless Steel.

| MODEL NUMBER | PIPE SIZE | A | | B | | C HEIGHT | CARTON QUANTITY | PALLET QUANTITY | LIST PRICE, Each Piece |
|------------------|--|---------------|---------------|---------------|---------------|------------|-----------------|-----------------|------------------------|
| | | MIN | MAX | MIN | MAX | | | | |
| MI-FLEX-CR-2150 | 2" C.I. / Plastic to 1 1/2" C.I. / Plastic | 2.40" (61) | 2.48" (53) | 1.82" (49) | 2.10" (53) | 3.90" (99) | 100 | 3,200 | \$22.00 |
| MI-FLEX-CR-300 | 3" C.I. / Plastic to 3" C.I. / Plastic | 3.38" (86) | 3.38" (86) | 3.38" (86) | 2.10" (53) | 3.90" (99) | 80 | 1,920 | \$26.00 |
| MI-FLEX-CRC-2150 | 2" C.I. / Plastic to 1 1/2" Copper | 2.40" (61) | 2.48" (53) | 1.53" (39) | 1.70" (43) | 2.14" (54) | 100 | 3,200 | \$24.00 |

CROSS REFERENCE

| MIFAB | BIBBY (CREMCO) |
|------------------|----------------|
| MI-FLEX-CR-2150 | 22340 |
| MI-FLEX-CR-300 | 22530 |
| MI-FLEX-CRC-2150 | 22400 |

CALIFORNIA PROPOSITION 65 WARNING. This product contains chemicals known to the State of California to cause cancer and birth defects or other reproductive harm.

Design and dimensions are subject to modification. Prices do not include applicable taxes. Visit www.mifab.com for the most recent product information.

MIFAB®, Inc., 1321 West 119th Street, Chicago, Illinois 60643-5109, USA

All sales subject to MIFAB's Terms and Warranties. Please refer to page 3.

Toll Free: 1-800-465-2736, Fax: 1-773-341-3049

sales@mifab.com • Canada Toll Free: 1-800-387-3880

MI-FLEX-CLAY FLEXIBLE COUPLINGS - CLAY TO CLAY

MIFAB's MI-FLEX-CLAY Series of flexible rubber couplings are used to connect clay pipe to clay pipe.

Note: For couplings with two bands, tighten 1-2, alternately until minimum 60 inch lbs. of torque is attained for each band. Tested to maintain 4.3 p.s.i. maximum line pressure (10' head pressure). All models conform to the National Plumbing Code of Canada and are manufactured in compliance with ASTM #C1173 and CSA B602 Standards. Non constant temperature rating is 140 F. Stainless Steel.

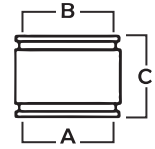

| MODEL NUMBER | PIPE SIZE | A | B | C HEIGHT | CARTON QUANTITY | PALLET QUANTITY | LIST PRICE, Each Piece |
|-------------------|---------------------|--------------|--------------|-------------|-----------------|-----------------|------------------------|
| MI-FLEX-CLAY-600 | 6" Clay x 6" Clay | 7.50" (191) | 7.50" (191) | 6" (152) | 40 | 500 | \$61.00 |
| MI-FLEX-CLAY-1212 | 12" Clay x 12" Clay | 14.51" (369) | 14.51" (369) | 6.38" (162) | 10 | 200 | \$151.75 |
| MI-FLEX-CLAY-1515 | 15" Clay x 15" Clay | 19.65" (499) | 18.15" (461) | 10" (254) | 4 | 10 | \$194.50 |

CROSS REFERENCE

| MIFAB | ANACO | FERNCO | HUSKY | MISSION | PASCO |
|-------------------|-------|-----------|-------|------------|-------|
| MI-FLEX-CLAY-600 | - | 1001-66 | - | MR 01 66 | 56166 |
| MI-FLEX-CLAY-1212 | - | 1001-1212 | - | MR 01 1212 | - |
| MI-FLEX-CLAY-1515 | - | 1001-1515 | - | MR 01 1515 | - |

MI-FLEX-SOS
FLEXIBLE COUPLINGS - PLASTIC SOCKET TO PLASTIC SOCKET

MIFAB's MI-FLEX-SOS Series of flexible rubber couplings are used to connect plastic socket to plastic socket pipe.

Note: For couplings with two bands, tighten 1-2, alternately until minimum 60 inch lbs. of torque is attained for each band. Tested to maintain 4.3 p.s.i. maximum line pressure (10' head pressure). Conforms to ASTM D5926. Use a 5/16" driver required to tighten bolts. Non constant temperature rating is 140 F. Stainless Steel Clamps and 5/16" hex head bolts are made from Type 300 Stainless Steel.

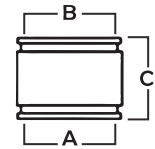

| MODEL NUMBER | PIPE SIZE | A | B | C HEIGHT | CARTON QUANTITY | PALLET QUANTITY | LIST PRICE, Each Piece |
|---------------|-------------------|-------------|-------------|-------------|-----------------|-----------------|------------------------|
| MI-FLEX-3-SOS | 3" Clay x 3" Clay | 3.94" (100) | 4.32" (110) | 3.94" (100) | 10 | 200 | \$25.00 |

CROSS REFERENCE

| MIFAB | ANACO | FERNCO | HUSKY | MISSION | PASCO |
|---------------|-------|---------|-------|---------|-------|
| MI-FLEX-3-SOS | - | 1060-33 | - | - | 6033 |

MI-FLEX-AH
FLEXIBLE COUPLINGS - ADS / HANCOR TO PVC

MIFAB's MI-FLEX-AH Series of flexible rubber couplings are used to connect ADS or Hancor corrugated pipe to PVC pipe.

Note: For couplings with two bands, tighten 1-2, alternately until minimum 60 inch lbs. of torque is attained for each band. Tested to maintain 4.3 p.s.i. maximum line pressure (10' head pressure). Conforms to ASTM D5926. Use a 5/16" driver required to tighten bolts. Non constant temperature rating is 140 F. Stainless Steel Clamps and 5/16" hex head bolts are made from Type 300 Stainless Steel.

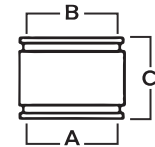

| MODEL NUMBER | PIPE SIZE | A | B | C HEIGHT | CARTON QUANTITY | PALLET QUANTITY | LIST PRICE, Each Piece |
|--------------|--|-------------|-------------|-------------|-----------------|-----------------|------------------------|
| MI-FLEX-3-AH | 3" ADS or Hancor corrugated polyethylene drain pipe x 3" PVC | 3.57" (91) | 3.44" (87) | 3.94" (100) | 10 | 200 | \$25.00 |
| MI-FLEX-4-AH | 4" ADS or Hancor corrugated polyethylene drain pipe x 4" PVC | 4.76" (121) | 4.29" (109) | 3.94" (100) | 10 | 200 | \$32.75 |

CROSS REFERENCE

| MIFAB | ANACO | FERNCO | HUSKY | MISSION | PASCO |
|--------------|-------|---------|-------|---------|-------|
| MI-FLEX-3-AH | - | 1070-33 | - | - | - |
| MI-FLEX-4-AH | - | 1070-44 | - | - | - |

CALIFORNIA PROPOSITION 65 WARNING. This product contains chemicals known to the State of California to cause cancer and birth defects or other reproductive harm.

MI-FLEX-EXP EXPANSION JOINTS

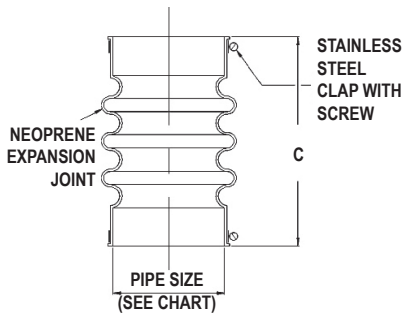

MIFAB's MI-FLEX-EXP Series of expansion joints are used to connect cast iron or plastic to cast iron or plastic pipe - 2", 3" and 4" sizes only. 6" and 8" models work with cast iron pipe only.

Note: For couplings with two bands, tighten 1-2, alternately until minimum 60 inch lbs. of torque is attained for each band. Tested to maintain 4.3 p.s.i. maximum line pressure (10' head pressure) 5/16" driver required to tighten bolts. Temperature range is 20 F to 120 F. 2", 3" and 4" models work with PVC and / or cast iron pipe. 6" and 8" models work with cast iron pipe only. For each model, the compression is 1", expansion is 1/2" and rotation is 10 degrees.

"I've been ordering MIFAB MI-HUB no hub couplings for the past 5 years. They make the ordering process simple and easy to do business with."
 - Bruce Hanson, Tri Rep Sales, Houston, TX

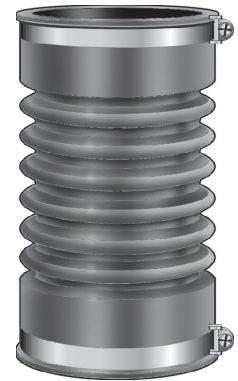

| MODEL NUMBER | PIPE SIZE | C HEIGHT | LIST PRICE, Each Piece |
|---------------|-----------|----------|------------------------|
| MI-FLEX-EXP-2 | 2" x 2" | 7 1/8" | \$66.50 |
| MI-FLEX-EXP-3 | 3" x 3" | 8 1/8" | \$72.75 |
| MI-FLEX-EXP-4 | 4" x 4" | 8 5/8" | \$90.75 |
| MI-FLEX-EXP-6 | 6" x 6" | 8 5/8" | \$121.00 |
| MI-FLEX-EXP-8 | 8" x 8" | 11" | \$203.75 |

CROSS REFERENCE

| MIFAB | ANACO | FERNCO | HUSKY | MISSION | PASCO |
|---------------|-------|--------|-------|------------|-------|
| MI-FLEX-EXP-2 | - | XJ-2 | - | MR56 22EXP | - |
| MI-FLEX-EXP-3 | - | XJ-3 | - | MR56 33EXP | - |
| MI-FLEX-EXP-4 | - | XJ-4 | - | MR56 44EXP | - |
| MI-FLEX-EXP-6 | - | - | - | - | - |
| MI-FLEX-EXP-8 | - | - | - | - | - |

MI-HUB-TRS SHIELDED TRANSITION COUPLINGS - PL / ST OR XHCI TO COPPER

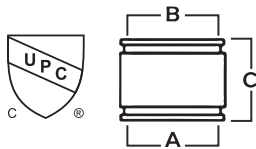

MIFAB's MI-HUB-TRS Series of shielded transition couplings are used to connect plastic, steel, or extra heavy cast iron pipe to copper pipe.

Note: For couplings with two bands, tighten 1-2, alternately until minimum 60 inch lbs. of torque is attained for each band. Tested to maintain 4.3 p.s.i. maximum line pressure (10' head pressure). All models are listed with I.A.P.M.O. (U.P.C.) 5/16" driver required to tighten bolts. All models are listed to the National Plumbing Code of Canada and relevant Canadian Standard(s) and bear the cUPC mark of conformity. All models are manufactured in compliance with ASTM #C1460 and CSA B602 Standards. Non constant temperature rating is 140 F. Stainless Steel Clamps and 5/16" hex head bolts are made from Type 300 Stainless Steel.



| MODEL NUMBER | PIPE SIZE | A WIDTH | B WIDTH | C HEIGHT | CARTON QUANTITY | PALLET QUANTITY | LIST PRICE, Each Piece |
|----------------|---|-------------|-------------|------------|-----------------|-----------------|------------------------|
| MI-HUB-TRS-330 | 3" Plastic, Steel or Extra Heavy Cast Iron to 3" Copper | 3.37" (86) | 3.52" (89) | 2.13" (54) | 100 | 2,400 | \$18.50 |
| MI-HUB-TRS-440 | 4" Plastic, Steel or Extra Heavy Cast Iron to 4" Copper | 4.36" (111) | 4.44" (113) | 2.13" (54) | 100 | 2,400 | \$26.50 |

CROSS REFERENCE

| MIFAB | ANACO | FERNCO | HUSKY | MISSION | PASCO |
|----------------|-------|---------|-------|---------|---------|
| MI-HUB-TRS-330 | - | 3007-33 | - | PK-33 | 5833-PK |
| MI-HUB-TRS-440 | - | 3007-44 | - | PK-44 | 5844-PK |

CALIFORNIA PROPOSITION 65 WARNING. This product contains chemicals known to the State of California to cause cancer and birth defects or other reproductive harm.

Design and dimensions are subject to modification. Prices do not include applicable taxes. Visit www.mifab.com for the most recent product information.

MIFAB®, Inc., 1321 West 119th Street, Chicago, Illinois 60643-5109, USA

All sales subject to MIFAB's Terms and Warranties. Please refer to page 3.

Toll Free: 1-800-465-2736, Fax: 1-773-341-3049

sales@mifab.com • Canada Toll Free: 1-800-387-3880

MI-HUB-TR SHIELDED TRANSITION COUPLINGS - CI, PL OR ST TO CI, PL OR ST

MIFAB's MI-HUB-TR Series of shielded transition couplings are used to connect cast iron, plastic or steel pipe to cast iron, plastic or steel pipe.

Note: For couplings with two bands, tighten 1-2, and couplings with four bands, tighten 2-3-1-4 alternately until minimum 60 inch lbs. of torque is attained for each band. Tested to maintain 4.3 p.s.i. maximum line pressure (10' head pressure). All models are listed with I.A.P.M.O. (U.P.C.) 5/16" driver required to tighten bolts. All models are listed to the National Plumbing Code of Canada and relevant Canadian Standard(s) and bear the cUPC mark of conformity. All models are manufactured in compliance with ASTM #C1460 and CSA B602 Standards. Non constant temperature rating is 140 F. Stainless Steel Clamps and 5/16" hex head bolts are made from Type 300 Stainless Steel.

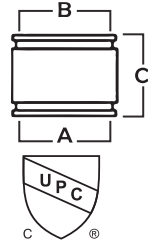

| MODEL NUMBER | PIPE SIZE | A WIDTH | B WIDTH | C HEIGHT | CARTON QUANTITY | PALLET QUANTITY | LIST PRICE, Each Piece |
|---------------|---|-------------|-------------|------------|-----------------|-----------------|------------------------|
| MI-HUB-TR-150 | 1 1/2" CI / PL / ST x 1 1/2" CI / PL / ST- Shielded Transition coupling | 1.95" (50) | 1.95" (50) | 2.13" (54) | 100 | 7,200 | \$11.50 |
| MI-HUB-TR-200 | 2" CI / PL / ST x 2" CI / PL / ST- Shielded Transition coupling | 2.28" (58) | 2.34" (59) | 2.13" (54) | 100 | 4,800 | \$11.50 |
| MI-HUB-TR-215 | 2" CI / PL / ST x 1 1/2" CI / PL / ST- Shielded Transition coupling | 1.93" (49) | 2.40" (61) | 2.13" (54) | 100 | 4,800 | \$15.50 |
| MI-HUB-TR-330 | 3" CI / PL / ST x 3" CI / PL / ST- Shielded Transition coupling | 3.37" (86) | 3.52" (89) | 2.13" (54) | 100 | 2,400 | \$17.75 |
| MI-HUB-TR-430 | 4" CI / PL / ST x 3" CI / PL / ST - Shielded Transition Coupling | 4.46" (113) | 3.46" (88) | 2.13" (54) | 100 | 2,400 | \$25.50 |
| MI-HUB-TR-440 | 4" CI x 4" CI / PL / ST- Shielded Transition coupling | 4.36" (111) | 4.44" (113) | 2.13" (54) | 100 | 2,400 | \$19.00 |
| MI-HUB-TR-550 | 5" CI x 5" CI / PL / ST- Shielded Transition coupling | 5" (127) | 5.18" (132) | 3" (76) | 30 | 720 | \$41.00 |
| MI-HUB-TR-660 | 6" CI x 6" CI / PL / ST- Shielded Transition coupling | 6.52" (166) | 6.15" (156) | 3" (76) | 30 | 720 | \$55.00 |
| MI-HUB-TR-880 | 8" CI x 8" CI / PL / ST- Shielded Transition coupling | 8.50" (216) | 8.31" (211) | 3.81" (97) | 20 | 320 | \$74.25 |

CROSS REFERENCE

| MIFAB | ANACO | FERNCO | HUSKY | MISSION | PASCO |
|---------------|--------|----------|--------|---------|---------|
| MI-HUB-TR-150 | 5010-C | 3000-150 | 5010-C | CP150 | 58150CP |
| MI-HUB-TR-200 | 5020-C | 3000-22 | 5020-C | CP200 | 58200CP |
| MI-HUB-TR-215 | 5023-C | 3000-215 | 5023-C | CP215 | 58215CP |
| MI-HUB-TR-330 | 5030-C | 3000-33 | 5030-C | CP33 | 5833CP |
| MI-HUB-TR-430 | 5041-C | 3000-43 | 5041-C | CP43 | - |
| MI-HUB-TR-440 | 5040-C | 3000-44 | 5040-C | CP44 | 5844CP |
| MI-HUB-TR-550 | 5050-C | 3000-55 | 5050-C | CP55 | 5855CP |
| MI-HUB-TR-660 | 5060-C | 3000-66 | 5060-C | CP66 | 5866CP |
| MI-HUB-TR-880 | 5080-C | 3000-88 | 5080-C | CP88 | 5888CP |

MI-HUB-TRC SHIELDED TRANSITION COUPLINGS - CI, PL OR ST TO COPPER OR PL

MIFAB's MI-HUB-TRC Series of shielded transition couplings are used to connect cast iron, plastic or steel pipe to copper or plastic pipe.

Note: For couplings with two bands, tighten 1-2, alternately until minimum 60 inch lbs. of torque is attained for each band. Tested to maintain 4.3 p.s.i. maximum line pressure (10' head pressure). All models are listed with I.A.P.M.O. (U.P.C.) 5/16" driver required to tighten bolts. All models are listed to the National Plumbing Code of Canada and relevant Canadian Standard(s) and bear the cUPC mark of conformity. All models are manufactured in compliance with ASTM #C1460 and CSA B602 Standards. Non constant temperature rating is 140 F. Stainless Steel Clamps and 5/16" hex head bolts are made from Type 300 Stainless Steel.

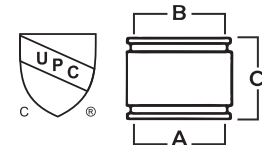

| MODEL NUMBER | PIPE SIZE | A WIDTH | B WIDTH | C HEIGHT | CARTON QUANTITY | PALLET QUANTITY | LIST PRICE, Each Piece |
|-----------------|---|-------------|-------------|------------|-----------------|-----------------|------------------------|
| MI-HUB-TRC-1125 | 1 1/2" CI / PL / ST x 1 1/4" Copper or 1 1/4" PL - Shielded Transition coupling | 1.91" (49) | 1.35" (34) | 2.13" (54) | 100 | 7,200 | \$18.50 |
| MI-HUB-TRC-150 | 1 1/2" CI / PL / ST x 1 1/2" Copper or 1 1/4" PL - Shielded Transition coupling | 1.95" (50) | 1.64" (42) | 2.13" (54) | 100 | 7,200 | \$16.00 |
| MI-HUB-TRC-2125 | 2" CI / PL / ST x 1 1/4" Copper or 1" PL - Shielded Transition coupling | 2.36" (60) | 1.29" (33) | 2.13" (54) | 100 | 4,800 | \$16.00 |
| MI-HUB-TRC-215 | 2" CI/PL/ST x 1 1/2" Copper or 2" PL - Shielded Transition coupling | 1.93" (49) | 2.40" (61) | 2.13" (54) | 100 | 4,800 | \$16.00 |
| MI-HUB-TRC-220 | 2" CI / PL / ST x 2" Copper - Shielded Transition coupling | 2.28" (58) | 2.34" (59) | 2.13" (54) | 100 | 4,800 | \$21.00 |
| MI-HUB-TRC-320 | 3" CI x 2" Copper - Shielded Transition coupling | 3.37" (86) | 2.34" (59) | 2.13" (54) | 100 | 2,400 | \$23.50 |
| MI-HUB-TRC-330 | 3" CI x 3" Copper - Shielded Transition coupling | 3.37" (86) | 3.52" (89) | 2.13" (54) | 100 | 2,400 | \$22.75 |
| MI-HUB-TRC-430 | 4" CI x 3" Copper - Shielded Transition coupling | 4.46" (113) | 3.46" (88) | 2.13" (54) | 100 | 2,400 | \$24.50 |
| MI-HUB-TRC-440 | 4" CI x 4" Copper - Shielded Transition coupling | 4.36" (111) | 4.44" (113) | 2.13" (54) | 100 | 2,400 | \$23.50 |

CROSS REFERENCE

| MIFAB | ANACO | FERNCO | HUSKY | MISSION | PASCO |
|-----------------|--------|-----------|--------|---------|----------|
| MI-HUB-TRC-1125 | 5010-C | 3001-1125 | 5010-C | CK1125 | 581125CK |
| MI-HUB-TRC-150 | 5011-C | 3001-150 | 5011-C | CK115 | 58115CK |
| MI-HUB-TRC-2125 | 5024-C | 3001-2125 | 5024-C | CK2125 | 582125CK |
| MI-HUB-TRC-215 | 5022-C | 3001-215 | 5022-C | CK215 | 58215CK |
| MI-HUB-TRC-220 | 5021-C | 3001-22 | 5021-C | CK22 | 5822CK |
| MI-HUB-TRC-320 | 5031-C | 3001-32 | 5031-C | CK32 | 5832CK |
| MI-HUB-TRC-330 | 5032-C | 3001-33 | 5032-C | CK33 | 5833CK |
| MI-HUB-TRC-430 | 5043-C | 3001-43 | 5043-C | CK43 | 5843CK |
| MI-HUB-TRC-440 | 5044-C | 3001-44 | 5044-C | CK44 | 5844CK |

CALIFORNIA PROPOSITION 65 WARNING. This product contains chemicals known to the State of California to cause cancer and birth defects or other reproductive harm.

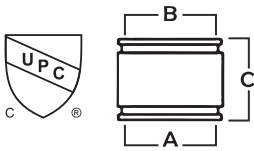
MI-HUB-TRP SHIELDED TRANSITION COUPLINGS - PL, ST, XHCI TO PL, ST OR XHCI

MIFAB's MI-HUB-TRP Series of shielded transition couplings are used to connect plastic, steel or extra heavy cast iron pipe to plastic, steel or extra heavy cast iron pipe.

Note: For couplings with two bands, tighten 1-2, and couplings with four bands, tighten 2-3-1-4 alternately until minimum 60 inch lbs. of torque is attained for each band. Tested to maintain 4.3 p.s.i. maximum line pressure (10' head pressure).

All models are listed with I.A.P.M.O. (U.P.C.) 5/16" driver required to tighten bolts. All models are listed to the National Plumbing Code of Canada and relevant Canadian Standard(s) and bear the cUPC mark of conformity. All models are manufactured in compliance with ASTM #C1460 and CSA B602 Standards. Non constant temperature rating is 140 F. Stainless Steel Clamps and 5/16" hex head bolts are made from Type 300 Stainless Steel.



| MODEL NUMBER | PIPE SIZE | A WIDTH | B WIDTH | C HEIGHT | CARTON QUANTITY | PALLET QUANTITY | LIST PRICE, Each Piece |
|----------------|---|-------------|-------------|------------|-----------------|-----------------|------------------------|
| MI-HUB-TRP-330 | 3" PL / ST or XH CI x 3" PL / ST, or XH CI - Shielded Transition coupling | 3.37" (86) | 3.52" (89) | 2.13" (54) | 100 | 2,400 | \$18.50 |
| MI-HUB-TRP-430 | 4" PL / ST or XH CI x 3" PL / ST, or XH CI - Shielded Transition coupling | 4.46" (113) | 3.46" (88) | 2.13" (54) | 100 | 2,400 | \$23.50 |
| MI-HUB-TRP-440 | 4" PL / ST or XH CI x 4" PL / ST, or XH CI - Shielded Transition coupling | 4.36" (111) | 4.44" (113) | 2.13" (54) | 100 | 2,400 | \$21.50 |
| MI-HUB-TRP-660 | 6" PL / ST or XH CI x 6" PL / ST, or XH CI - Shielded Transition coupling | 6.52" (166) | 6.15" (156) | 3" (76) | 100 | 2,400 | \$55.00 |

CROSS REFERENCE

| MIFAB | ANACO | FERNCO | HUSKY | MISSION | PASCO |
|----------------|--------|---------|--------|---------|--------|
| MI-HUB-TRP-330 | 5304-C | 3005-33 | 5304-C | P-300 | 58300P |
| MI-HUB-TRP-430 | 5406-C | 3005-43 | 5406-C | P-430 | 58430P |
| MI-HUB-TRP-440 | 5405-C | 3005-44 | 5405-C | P-400 | 58400P |
| MI-HUB-TRP-660 | 5601-C | 3005-66 | 5601-C | P-600 | 58600P |

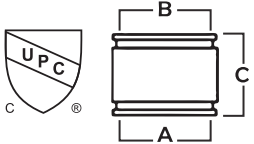
MI-HUB-TRT SHIELDED TRANSITION COUPLINGS - CI, PL OR ST TO TUBULAR

MIFAB's MI-HUB-TRT Series of shielded transition couplings are used to connect cast iron, plastic or steel pipe to tubular pipe.

Note: For couplings with two bands, tighten 1-2 alternately until minimum 60 inch lbs. of torque is attained for each band. Tested to maintain 4.3 p.s.i. maximum line pressure (10' head pressure).

All models are listed with I.A.P.M.O. (U.P.C.) 5/16" driver required to tighten bolts. All models are listed to the National Plumbing Code of Canada and relevant Canadian Standard(s) and bear the cUPC mark of conformity. All models are manufactured in compliance with ASTM #C1460 and CSA B602 Standards. Non constant temperature rating is 140 F. Stainless Steel Clamps and 5/16" hex head bolts are made from Type 300 Stainless Steel.



| MODEL NUMBER | PIPE SIZE | A WIDTH | B WIDTH | C HEIGHT | CARTON QUANTITY | PALLET QUANTITY | LIST PRICE, Each Piece |
|----------------|---|------------|------------|------------|-----------------|-----------------|------------------------|
| MI-HUB-TRT-150 | 1 1/2" CI / PL / ST x 1 1/2" Tubular - Shielded Transition coupling | 1.95" (50) | 1.64" (42) | 2.13" (54) | 100 | 4,800 | \$18.75 |
| MI-HUB-TRT-155 | 1 1/2" Tubular x 1 1/2" Tubular - Shielded Transition coupling | 1.95" (50) | 1.64" (42) | 2.13" (54) | 100 | 4,800 | \$21.50 |
| MI-HUB-TRT-215 | 2" CI / PL / ST x 1 1/2" Tubular - Shielded Transition coupling | 1.93" (49) | 2.40" (61) | 2.13" (54) | 100 | 4,800 | \$21.50 |

CROSS REFERENCE

| MIFAB | ANACO | FERNCO | HUSKY | MISSION | PASCO |
|----------------|--------|----------|--------|---------|----------|
| MI-HUB-TRT-150 | 5108-C | 3002-150 | 5108-C | T-150 | 58150T |
| MI-HUB-TRT-155 | 5109-C | 3002-155 | 5109-C | BWT-150 | 58150BWT |
| MI-HUB-TRT-215 | 5210-C | 3002-215 | 5210-C | T-215 | 58215T |

CALIFORNIA PROPOSITION 65 WARNING. This product contains chemicals known to the State of California to cause cancer and birth defects or other reproductive harm.

Design and dimensions are subject to modification. Prices do not include applicable taxes. Visit www.mifab.com for the most recent product information.

MIFAB®, Inc., 1321 West 119th Street, Chicago, Illinois 60643-5109, USA

All sales subject to MIFAB's Terms and Warranties. Please refer to page 3.

Toll Free: 1-800-465-2736, Fax: 1-773-341-3049

sales@mifab.com • Canada Toll Free: 1-800-387-3880

MI-HUB-TRCC SHIELDED TRANSITION COUPLINGS - COPPER TO COPPER OR PL



MIFAB's MI-HUB-TRCC Series of shielded transition couplings are used to connect copper pipe to copper or plastic pipe.

Note: For couplings with two bands, tighten 1-2 alternately until minimum 60 inch lbs. of torque is attained for each band. Tested to maintain 4.3 p.s.i. maximum line pressure (10' head pressure).

All models are listed with I.A.P.M.O. (U.P.C.) 5/16" driver required to tighten bolts. All models are listed to the National Plumbing Code of Canada and relevant Canadian Standard(s) and bear the cUPC mark of conformity. All models are manufactured in compliance with ASTM #C1460 and CSA B602 Standards. Non constant temperature rating is 140 F. Stainless Steel Clamps and 5/16" hex head bolts are made from Type 300 Stainless Steel.

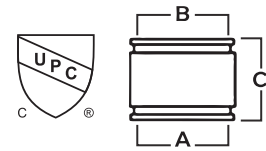

"MIFAB's no hub couplings were in the specifications and the pricing was competitive."

— Anthony J. Lampuri, ABL Mechanical, Raleigh, NC

| MODEL NUMBER | PIPE SIZE | A WIDTH | B WIDTH | C HEIGHT | CARTON QUANTITY | PALLET QUANTITY | LIST PRICE, Each Piece |
|------------------|--|------------|------------|------------|-----------------|-----------------|------------------------|
| MI-HUB-TRCC-1125 | 1 1/2" Copper or 1 1/4" Plastic to 1 1/4" Copper or 1" Plastic | 1.91" (49) | 1.35" (34) | 2.13" (54) | 100 | 7,200 | \$28.25 |
| MI-HUB-TRCC-150 | 1 1/2" Copper or 1 1/4" Plastic to 1 1/2" Copper or 1 1/4" Plastic | 1.95" (50) | 1.64" (42) | 2.13" (54) | 100 | 7,200 | \$17.75 |
| MI-HUB-TRCC-215 | 2" Copper to 1 1/2" Copper or 1 1/4" Plastic | 1.93" (49) | 2.40" (61) | 2.13" (54) | 100 | 7,200 | \$18.50 |
| MI-HUB-TRCC-220 | 2" Copper to 2" Copper | 2.28" (58) | 2.34" (59) | 2.13" (54) | 100 | 7,200 | \$18.50 |
| MI-HUB-TRCC-330 | 3" Copper to 3" Copper | 3.37" (86) | 3.52" (89) | 2.13" (54) | 100 | 7,200 | \$21.25 |

CROSS REFERENCE

| MIFAB | ANACO | FERNCO | HUSKY | MISSION | PASCO |
|------------------|-------|----------|-------|---------|--------|
| MI-HUB-TRCC-1125 | - | - | - | K1125 | - |
| MI-HUB-TRCC-150 | - | 3003-150 | - | K150 | 58150K |
| MI-HUB-TRCC-215 | - | 3003-215 | - | K215 | 58215K |
| MI-HUB-TRCC-220 | - | 3003-22 | - | K200 | 58200K |
| MI-HUB-TRCC-300 | - | 3003-33 | - | K300 | 58300K |

MI-HUB-TRTW SHIELDED TRANSITION COUPLINGS - THINWALL PL TO SCH. 40 PL OR ST



MIFAB's MI-HUB-TRTW Series of shielded transition couplings are used to connect thinwall plastic to Schedule 40 plastic or steel pipe.

Note: For couplings with two bands, tighten 1-2 alternately until minimum 60 inch lbs. of torque is attained for each band. Tested to maintain 4.3 p.s.i. maximum line pressure (10' head pressure)

All models are listed with I.A.P.M.O. (U.P.C.) 5/16" driver required to tighten bolts. All models are listed to the National Plumbing Code of Canada and relevant Canadian Standard(s) and bear the cUPC mark of conformity. All models are manufactured in compliance with ASTM #C1460 and CSA B602 Standards. Non constant temperature rating is 140 F. Stainless Steel Clamps and 5/16" hex head bolts are made from Type 300 Stainless Steel.

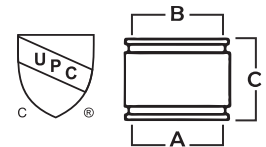

| MODEL NUMBER | PIPE SIZE | A WIDTH | B WIDTH | C HEIGHT | CARTON QUANTITY | PALLET QUANTITY | LIST PRICE, Each Piece |
|-----------------|--|-------------|-------------|------------|-----------------|-----------------|------------------------|
| MI-HUB-TRTW-440 | 4" Thinwall Plastic to 4" Schedule 40 Plastic or Steel | 4.36" (111) | 4.44" (113) | 2.13" (54) | 100 | 2,400 | \$19.75 |

CROSS REFERENCE

| MIFAB | ANACO | FERNCO | HUSKY | MISSION | PASCO |
|-----------------|-------|---------|-------|---------|---------|
| MI-HUB-TRTW-440 | - | 3009-33 | - | TWP-44 | 5844TWP |

CALIFORNIA PROPOSITION 65 WARNING. This product contains chemicals known to the State of California to cause cancer and birth defects or other reproductive harm.

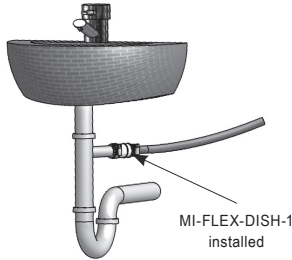
MI-FLEX-DISH DISHWASHER CONNECTOR

(Typical Installation underneath a sink)

MIFAB's MI-FLEX-DISH connects a dishwasher hose to a sink drain or garbage disposer. They are made out of flexible PVC.

Note: For couplings with two bands, tighten 1-2 alternately until minimum 60 inch lbs. of torque is attained for each band. Tested to maintain 4.3 p.s.i. maximum line pressure (10' head pressure) 5/16" driver required to tighten bolts.



| MODEL NUMBER | PIPE SIZE | A WIDTH | B WIDTH | C HEIGHT | CARTON QUANTITY | LIST PRICE, Each Piece |
|----------------|-----------------|-----------|-----------|------------|-----------------|------------------------|
| MI-FLEX-DISH-1 | .75" or 1" x 1" | .64" (16) | .92" (23) | 2.70" (69) | 100 | \$6.25 |

CROSS REFERENCE

| MIFAB | ANACO | FERNCO | HUSKY | MISSION | PASCO |
|----------------|-------|---------|-------|-----------|-------|
| MI-FLEX-DISH-1 | - | DWC-100 | - | MRDWC 150 | 496 |

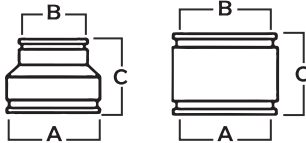
MI-FLEX-DTC FLEXIBLE COUPLINGS - TUBULAR TO DRAIN PIPE

MIFAB's MI-FLEX-DTC Series of flexible rubber couplings are used to connect tubular traps to common household drain pipe for new installation, repairs and alterations.

Note: For couplings with two bands, tighten 1-2 alternately until minimum 60 inch lbs. of torque is attained for each band. Tested to maintain 4.3 p.s.i. maximum line pressure (10' head pressure)

All models are listed with I.A.P.M.O. (U.P.C.) 5/16" driver required to tighten bolts. All models are listed to the National Plumbing Code of Canada and relevant Canadian Standard(s) and bear the cUPC mark of conformity. All models are manufactured in compliance with ASTM #C1173 and CSA B602 Standards. Non constant temperature rating is 140 F.

Stainless Steel Clamps and 5/16" hex head bolts are made from Type 300 Stainless Steel.



| MODEL NUMBER | PIPE SIZE | A | | B | | C HEIGHT | CARTON QUANTITY | PALLET QUANTITY | LIST PRICE, Each Piece |
|-----------------|--|------------|------------|------------|------------|------------|-----------------|-----------------|------------------------|
| | | MIN | MAX | MIN | MAX | | | | |
| MI-FLEX-DTC-110 | 1 1/2" tubular traps to 3/4" or 1" K (copper) / drain piping | 1.90" (48) | 2.22" (56) | 1.35" (34) | 1.95" (50) | 2.34" (59) | 100 | 6,300 | \$12.75 |
| MI-FLEX-DTC-150 | 1 1/4" or 1 1/2" tubular traps to 1 1/4" or 1 1/2" drain piping | 1.46" (37) | 1.69" (43) | 1.95" (50) | 2.16" (55) | 2.25" (57) | 100 | 6,300 | \$11.75 |
| MI-FLEX-DTC-210 | 2" tubular to 3/4" or 1" K (copper) / drain piping | 2.32" (59) | 2.54" (64) | 1.27" (32) | 1.50" (38) | 2.25" (57) | 100 | 6,300 | \$16.50 |
| MI-FLEX-DTC-215 | 1 1/4" or 1 1/2" tubular traps to 2" drain piping (except copper. For 2" copper, use MI-FLEX-DTC-150). | 1.46" (37) | 1.70" (43) | 2.38" (61) | 2.62" (67) | 2.31" (59) | 100 | 6,300 | \$15.75 |

CROSS REFERENCE

| MIFAB | ANACO | FERNCO | HUSKY | MISSION | PASCO |
|-----------------|-------|---------|-------|-----------|-------|
| MI-FLEX-DTC-110 | - | DTC-110 | - | MRDTC 110 | - |
| MI-FLEX-DTC-150 | - | DTC-150 | - | MRDTC 150 | 5,915 |
| MI-FLEX-DTC-210 | - | DTC-210 | - | MRDTC 210 | - |
| MI-FLEX-DTC-215 | - | DTC-215 | - | MRDTC 215 | 5,925 |

CALIFORNIA PROPOSITION 65 WARNING. This product contains chemicals known to the State of California to cause cancer and birth defects or other reproductive harm.

Design and dimensions are subject to modification. Prices do not include applicable taxes. Visit www.mifab.com for the most recent product information.

MIFAB®, Inc., 1321 West 119th Street, Chicago, Illinois 60643-5109, USA

All sales subject to MIFAB's Terms and Warranties. Please refer to page 3.

Toll Free: 1-800-465-2736, Fax: 1-773-341-3049

sales@mifab.com • Canada Toll Free: 1-800-387-3880

C1440-NH
EXPANDABLE MECHANICAL STOPPERS

MIFAB's C1440-NH Series of expandable mechanical stoppers are used to test gravity flow, non pressure DWV and sewer systems. The plastic plug will expand into the pipe opening as it is tightened. The C1440-NH Series meets and exceeds the ASTM Standard C425 requirements.

"We love the ease of use of MIFAB's no hub couplings. They save us money on labor costs during all of our projects."

– Paul Weisenberg, Weisenberg Plumbing, New York, NY

| MODEL NUMBER | PIPE SIZE | LIST PRICE, Each Piece |
|--------------|--|------------------------|
| C1441.5-NH | 1 1/2" Cast Iron, Schedule 40 Plastic or Steel | \$5.25 |
| C1442-NH | 2" Cast Iron, Schedule 80 Plastic or 1 1/2" Schedule 40 Plastic Hub | \$5.75 |
| C1443-NH | 3" Cast Iron, Schedule 40 Plastic, Steel, SDR 35 Plastic, Copper (DWV), Clay | \$7.00 |
| C1444-NH | 4" Cast Iron, Schedule 40 Plastic, Steel, SDR 35 Plastic, Copper (DWV), Clay | \$11.00 |

CROSS REFERENCE

| MIFAB | ANACO | FERNCO | HUSKY | MISSION | PASCO |
|------------|-------|--------|-------|---------|-------|
| C1441.5-NH | - | - | - | ST-152 | 4803 |
| C1442-NH | - | - | - | ST-201 | 4804 |
| C1443-NH | - | - | - | ST-301 | 4806 |
| C1444-NH | - | - | - | ST-402 | 4808 |

MI-EC
END CAPS

MIFAB's flexible rubber end caps are used to cap pipe ends, cleanouts and open pipes. They are suitable for above ground or underground use on cast iron, steel, PVC or ABS pipes.

Tested and Certified to I.A.P.M.O. Standard PS 90-06. All models are listed with I.A.P.M.O. (U.P.C.) 5/16" driver required to tighten bolts. All models are listed to the National Plumbing Code of Canada and relevant Canadian Standard(s) and bear the cUPC mark of conformity. All models are manufactured in compliance with IAPMO PS 90-06 and the CSA B602 Standard. Non constant temperature rating is 140 F.

Stainless Steel Clamp and 5/16" hex head bolt are made from Type 300 Stainless Steel. Tighten the band until 60 inch lbs. torque is attained.

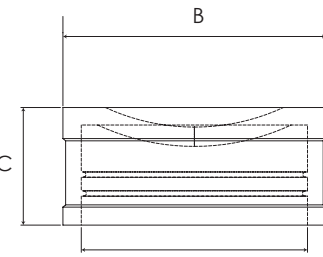

| MODEL NUMBER | PIPE SIZE | A WIDTH | B WIDTH | C HEIGHT | CARTON QUANTITY | PALLET QUANTITY | LIST PRICE, Each Piece |
|--------------|---|--------------|--------------|------------|-----------------|-----------------|------------------------|
| MI-EC-125 | "1 1/4" PL - 1 1/4" ST - 1 1/2" Copper - 1 1/2" SS" | 1.65" (42) | 2.10" (53) | 1.58" (40) | 160 | 11,520 | \$6.75 |
| MI-EC-150 | 1 1/2" | 1.61" (41) | 1.95" (50) | 1.15" (29) | 160 | 11,520 | \$7.75 |
| MI-EC-200 | 2" | 1.94" (49) | 2.48" (63) | 1.25" (32) | 150 | 10,350 | \$8.50 |
| MI-EC-250 | 2" Duriron | 2.72" (69) | 3.21" (82) | 1.65" (42) | 150 | 10,350 | \$14.75 |
| MI-EC-300 | 3" | 3.09" (79) | 3.63" (92) | 1.39" (35) | 100 | 4,800 | \$11.00 |
| MI-EC-400 | 4" | 3.96" (101) | 4.60" (117) | 1.65" (42) | 80 | 3,200 | \$13.75 |
| MI-EC-500 | 5" | 5.03" (128) | 5.85" (149) | 2.09" (53) | 40 | - | \$18.00 |
| MI-EC-600 | 6" | 5.73" (146) | 6.62" (168) | 2.20" (56) | 40 | - | \$18.75 |
| MI-EC-800 | 8" | 7.70" (196) | 8.85" (225) | 2.95" (75) | 40 | - | \$38.00 |
| MI-EC-1000 | 10" | 10.50" (267) | 11.80" (300) | 2.80" (71) | 10 | - | \$52.00 |

CROSS REFERENCE

| MIFAB | ANACO | FERNCO | HUSKY | MISSION | PASCO |
|------------|-------|---------|-------|----------|-------|
| MI-EC-125 | - | QC-1.68 | - | - | - |
| MI-EC-150 | 9329 | QC-101 | 9329 | 0701 011 | 4417 |
| MI-EC-200 | 9330 | QC-102 | 9330 | 0702 019 | 4418 |
| MI-EC-250 | - | QC-275 | - | - | - |
| MI-EC-300 | 9331 | QC-103 | 9331 | 0703 017 | 4419 |
| MI-EC-400 | 9332 | QC-104 | 9332 | 0704 015 | 4422 |
| MI-EC-500 | - | QC-105 | - | 0705 020 | 4840 |
| MI-EC-600 | - | QC-106 | - | 0706 028 | 4841 |
| MI-EC-800 | - | QC-108 | - | 0708 016 | 4842 |
| MI-EC-1000 | - | QC-110 | - | 0710 017 | - |

CALIFORNIA PROPOSITION 65 WARNING. This product contains chemicals known to the State of California to cause cancer and birth defects or other reproductive harm.

C1440-TP

ECONOMY TEST PLUGS

Specification: MIFAB C1440-TP Series of economy test plugs with galvanized steel flange, neoprene rubber gasket, and galvanized steel wing nut operating screw. Temperature rating of 0° – 125° F.

Function: Fits into cast iron and / or plastic pipe to seal the pipe opening. Operates within a 2 p.s.i. back pressure. Ideal for pressure tests of sewer pipes through test connection with hollow screw. The test plug offers a simple and quick installation by inserting it into the pipe end (spigot end or socket).

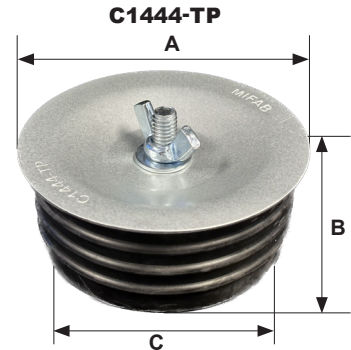
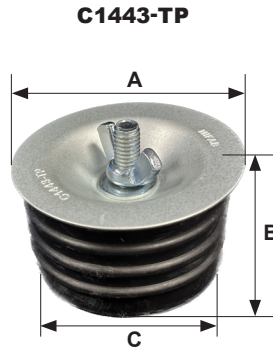

| MODEL NUMBER | PIPE SIZE | A | B | C | WEIGHT (OUNCES) | LIST PRICE |
|--------------|-----------|--------|--------|--------|-----------------|--------------------|
| C1441.5-TP | 1 1/2" | 2 1/4" | 1 1/8" | 1 1/2" | 5.00 | see CLPB-2025 book |
| C1442-TP | 2" | 2 1/4" | 1 1/8" | 1 3/4" | 7.00 | |
| C1443-TP | 3" | 3 1/4" | 1 5/8" | 2 3/4" | 8.50 | |
| C1444-TP | 4" | 4 1/4" | 1 5/8" | 3 3/4" | 12.50 | |
| C1446-TP | 6" | 6 1/4" | 1 5/8" | 5 3/4" | 18.00 | |

CALIFORNIA PROPOSITION 65 WARNING. This product contains chemicals known to the State of California to cause cancer and birth defects or other reproductive harm.

Design and dimensions are subject to modification. Prices do not include applicable taxes. Visit www.mifab.com for the most recent product information.

MIFAB®, Inc., 1321 West 119th Street, Chicago, Illinois 60643-5109, USA

All sales subject to MIFAB®'s Terms and Warranties. Please refer to page 3.

Toll Free: 1-800-465-2736, Fax: 1-773-341-3049

sales@mifab.com • Canada Toll Free: 1-800-387-3880

MI-ELB ELBOWS

MIFAB's MI-ELB Series of flexible rubber Elbows are used to connect all common household drain, waste and vent pipes quickly. They are extra long to replace fittings cut out at the joint during alteration or repair. All models are listed with I.A.P.M.O. Non constant temperature rating is 140 F. Stainless Steel Clamps and 5/16" hex head bolts are made from Type 300 Stainless Steel. Tighten the bands alternately until 60 inch pounds torque is attained.

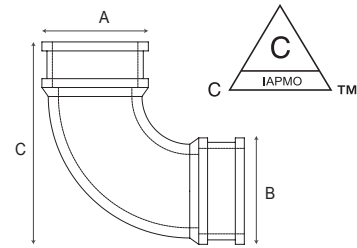

| MODEL NUMBER | PIPE SIZE | A WIDTH | B WIDTH | C HEIGHT | CARTON QUANTITY | PALLET QUANTITY | LIST PRICE, Each Piece |
|--------------|--------------|-------------|-------------|-------------|-----------------|-----------------|------------------------|
| MI-ELB-150 | 1 1/2" Elbow | 1.90" (48) | 1.90" (48) | 4.46" (113) | 50 | 2,700 | \$21.75 |
| MI-ELB-200 | 2" Elbow | 2.31" (59) | 2.31" (59) | 5.17" (131) | 20 | 1,680 | \$23.50 |
| MI-ELB-300 | 3" Elbow | 3.44" (87) | 3.44" (87) | 7.87" (200) | 20 | 560 | \$34.75 |
| MI-ELB-400 | 4" Elbow | 4.44" (113) | 4.44" (113) | 9.63" (245) | 6 | 294 | \$51.00 |

CROSS REFERENCE

| MIFAB | ANACO | FERNCO | HUSKY | MISSION | PASCO |
|------------|-------|--------|-------|----------|-------|
| MI-ELB-150 | - | QL-150 | - | M9OL 150 | 5815 |
| MI-ELB-200 | - | QL-200 | - | M9OL 200 | 5822 |
| MI-ELB-300 | - | QL-300 | - | M9OL 300 | 5833 |
| MI-ELB-400 | - | QL-400 | - | M9OL 400 | 5844 |

MI-TEE TEES

MIFAB's MI-TEE Series of flexible rubber Tees are used to connect all common household drain, waste and vent pipes quickly. They are extra long to replace fittings cut out at the joint during alteration or repair. All models are listed with I.A.P.M.O. Non constant temperature rating is 140 F. Stainless Steel Clamps and 5/16" hex head bolts are made from Type 300 Stainless Steel. Tighten the bands alternately until 60 inch pounds torque is attained.

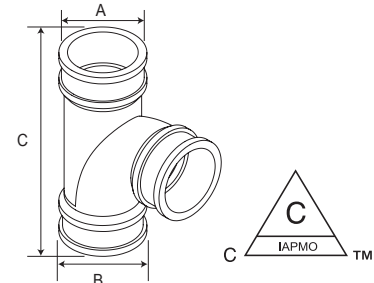

| MODEL NUMBER | PIPE SIZE | A WIDTH | B WIDTH | C HEIGHT | CARTON QUANTITY | PALLET QUANTITY | LIST PRICE, Each Piece |
|--------------|------------|-------------|-------------|-------------|-----------------|-----------------|------------------------|
| MI-TEE-150 | 1 1/2" Tee | 1.90" (48) | 1.90" (48) | 4.46" (113) | 50 | 2,700 | \$27.25 |
| MI-TEE-200 | 2" Tee | 2.31" (59) | 2.31" (59) | 5.17" (131) | 20 | 1,680 | \$29.50 |
| MI-TEE-300 | 3" Tee | 3.44" (87) | 3.44" (87) | 7.87" (200) | 20 | 560 | \$45.00 |
| MI-TEE-400 | 4" Tee | 4.44" (113) | 4.44" (113) | 9.63" (245) | 6 | 294 | \$62.75 |

CROSS REFERENCE

| MIFAB | ANACO | FERNCO | HUSKY | MISSION | PASCO |
|------------|-------|--------|-------|---------|-------|
| MI-TEE-150 | - | QT-150 | - | MTY 150 | 5715 |
| MI-TEE-200 | - | QT-200 | - | MTY 200 | 5722 |
| MI-TEE-300 | - | QT-300 | - | MTY 300 | 5733 |
| MI-TEE-400 | - | QT-400 | - | MTY 400 | 5744 |

CALIFORNIA PROPOSITION 65 WARNING. This product contains chemicals known to the State of California to cause cancer and birth defects or other reproductive harm.

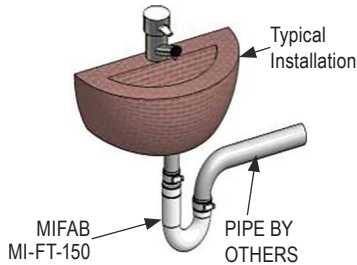
MI-FT "J" BEND FLEXIBLE CONNECTOR

MIFAB's MI-FT Series of flexible rubber "J" bend connectors are used to connect 1 1/4" or 1 1/2" Cast iron (CI), Plastic (PL), Steel (ST) or Copper (K) drain pipe to 1 1/4" or 1 1/2" Cast iron (CI), Plastic (PL), Steel (ST) or Copper (K) drain pipe or tubular trap. The flexible PVC material adjusts to pipe misalignment for an easy installation. Ideal to replace 1 1/4" or 1 1/2" plastic or metal p-traps. Applicable for above ground gravity (non pressure) flow applications only. Stainless Steel Clamp and 5/16" hex head bolt are made from Type 300 Stainless Steel. Tighten the bands alternately until 60 inch pounds torque is attained.



| MODEL NUMBER | PIPE SIZE | CARTON QUANTITY | PALLET QUANTITY | LIST PRICE, Each Piece |
|--------------|--|-----------------|-----------------|------------------------|
| MI-FT-150 | 1 1/4" OR 1 1/2" CI/PL/ST/K TO 1 1/2" CI/PL/ST/K/T | 20 | 400 | \$19.00 |

CROSS REFERENCE

| MIFAB | ANACO | FERNCO | HUSKY | MISSION | PASCO |
|-----------|-------|--------|-------|---------|-------|
| MI-FT-150 | - | FT-150 | - | MJB 150 | 5900 |

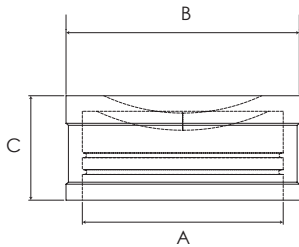
MI-EC-HB END CAP WITH HOSE BIBB

MIFAB's flexible rubber end caps with hose bibb are used to cap pipe ends, cleanouts and open pipes. They are suitable for above ground or underground use on cast iron, steel, PVC or ABS pipes. 5/16" driver required to tighten bolts to 60 lbs. torque. All models are manufactured in compliance with IAPMO PS 90-06 and the CSA B602 Standard. Non constant temperature rating is 140 F. Stainless Steel Clamp and 5/16" hex head bolt are made from Type 300 Stainless Steel. Tighten the bands alternately until 60 inch pounds torque is attained.



"MIFAB manufactures a quality coupling, easy to install, and definitely a time saver."

– Forest Powell, General Foreman, Collins Plumbing, San Diego, CA

| MODEL NUMBER | PIPE SIZE | A WIDTH | B WIDTH | C HEIGHT | CARTON QUANTITY | LIST PRICE, Each Piece |
|--------------|-----------|-------------|-------------|------------|-----------------|------------------------|
| MI-EC-150-HB | 1 1/2" | 1.61" (41) | 1.95" (50) | 1.15" (29) | 50 | \$29.00 |
| MI-EC-200-HB | 2" | 1.94" (49) | 2.48" (63) | 1.25" (32) | 50 | \$29.50 |
| MI-EC-300-HB | 3" | 3.09" (79) | 3.63" (92) | 1.39" (35) | 40 | \$32.50 |
| MI-EC-400-HB | 4" | 3.96" (101) | 4.60" (117) | 1.65" (42) | 20 | \$34.50 |
| MI-EC-500-HB | 5" | 5.03" (128) | 5.85" (149) | 2.09" (53) | 10 | \$42.25 |
| MI-EC-600-HB | 6" | 5.73" (146) | 6.62" (168) | 2.20" (56) | 10 | \$45.00 |

CROSS REFERENCE

| MIFAB | ANACO | FERNCO | HUSKY | MISSION | PASCO |
|--------------|-------|--------|-------|---------|--------|
| MI-EC-150-HB | - | HBC-1 | - | 701516 | 4857HB |
| MI-EC-200-HB | - | HBC-2 | - | 702514 | 4858HB |
| MI-EC-300-HB | - | HBC-3 | - | 703512 | 4859HB |
| MI-EC-400-HB | - | HBC-4 | - | 704510 | 4860HB |
| MI-EC-500-HB | - | - | - | 705517 | - |
| MI-EC-600-HB | - | - | - | 706515 | - |

CALIFORNIA PROPOSITION 65 WARNING. This product contains chemicals known to the State of California to cause cancer and birth defects or other reproductive harm.

Design and dimensions are subject to modification. Prices do not include applicable taxes. Visit www.mifab.com for the most recent product information.

MIFAB®, Inc., 1321 West 119th Street, Chicago, Illinois 60643-5109, USA
All sales subject to MIFAB's Terms and Warranties. Please refer to page 3.

Toll Free: 1-800-465-2736, Fax: 1-773-341-3049
sales@mifab.com • Canada Toll Free: 1-800-387-3880

MI-JS
COMPRESSION JOINT SEALER

MIFAB's MI-JS rolling style compression joint sealer o-ring is used to connect 4" Clay, Plastic or Steel pipe to 6" Clay, Plastic or Steel pipe in DWV systems. The MI-JS fits 4.20" through to 4.60" O.D. house pipe and fits 5.75" to 6" I.D. sewer pipe. Applicable for above ground gravity (non pressure) flow applications only.



| MODEL NUMBER | PIPE SIZE | CARTON QUANTITY | PALLET QUANTITY | LIST PRICE, Each Piece |
|--------------|----------------------------|-----------------|-----------------|------------------------|
| MI-JS | 4" CL/PL/ST TO 6" CL/PL/ST | 30 | 600 | \$16.50 |

CROSS REFERENCE

| MIFAB | ANACO | FERNCO | HUSKY | MISSION | PASCO |
|-------|-------|--------|-------|-----------|-------|
| MI-JS | - | BR 64 | - | MR 64 (N) | - |

MI-SCON
SHOWER AND DRAIN CONNECTOR

MIFAB's MI-SCON Series of shower drain connectors are used to connect Cast Iron (CI), Schedule 40 Plastic (PL), or Steel (ST) pipe to shower drain bodies. For non-pressure, gravity flow applications only. Above ground installations.

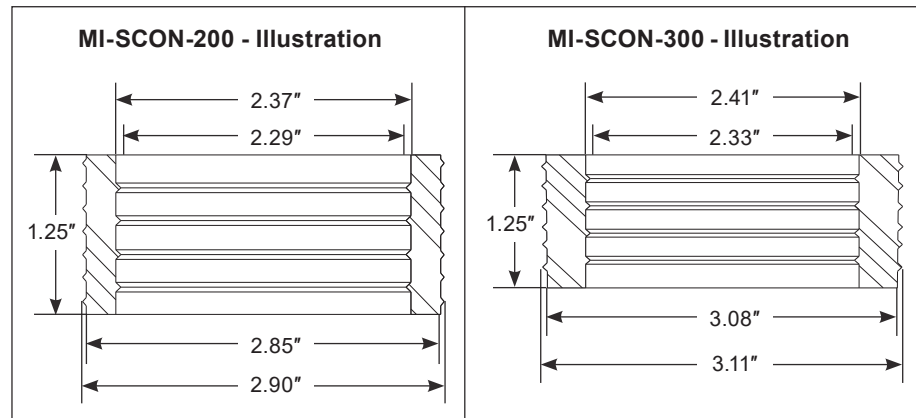
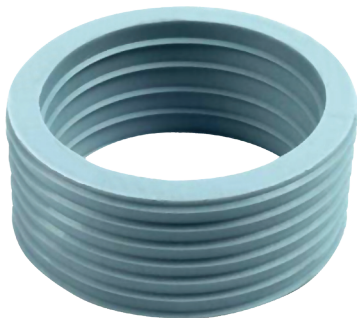

| MODEL NUMBER | PIPE SIZE | CARTON QUANTITY | PALLET QUANTITY | LIST PRICE, Each Piece |
|--------------|----------------------------|-----------------|-----------------|------------------------|
| MI-SCON-200 | 2" CI/PL/ST TO 2" CI/PL/ST | 20 | 500 | \$7.00 |
| MI-SCON-300 | 3" CI/PL/ST TO 3" CI/PL/ST | 20 | 500 | \$10.25 |

CROSS REFERENCE

| MIFAB | ANACO | FERNCO | HUSKY | MISSION | PASCO |
|-------------|-------|--------|-------|---------|-------|
| MI-SCON-200 | - | SD-200 | - | MSD 200 | - |

CALIFORNIA PROPOSITION 65 WARNING. This product contains chemicals known to the State of California to cause cancer and birth defects or other reproductive harm.

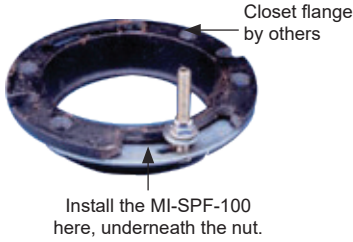
MI-SPF-100
WATER CLOSET REPAIR FLANGE
**Application image
MI-SPF-100**

MIFAB's MI-SPF-100 fabricated 10 gauge steel, powder epoxy coated water closet repair flange is ideal for the repair of broken toilet flanges. It permits the repair of broken toilet flanges without having to replace the entire toilet flange. Simply install the MI-SPF-100 under the broken area of the closet flange and tighten the nut. Applicable for all cast iron, plastic, copper and brass toilet flanges.

MI-SPF-100

| MODEL NUMBER | CARTON QUANTITY | PALLET QUANTITY | LIST PRICE, Each Piece |
|--------------|-----------------|-----------------|------------------------|
| MI-SPF-100 | 24 | 500 | \$11.00 |

CROSS REFERENCE

| MIFAB | ANACO | FERNCO | HUSKY | MISSION | PASCO |
|------------|-------|---------|-------|---------|-------|
| MI-SPF-100 | - | PSF-100 | - | MRTRF | - |

MI-SEW
SEWER TAP SADDLES

MIFAB's MI-SEW Series of sewer tap saddles are made from flexible PVC and are used to connect Schedule 40 plastic lateral pipe to the sewer main.

Stainless Steel Clamps and 5/16" hex bolts are made from Type 300 Stainless Steel.

Non-pressure, gravity flow applications only. For underground installations. Tighten the bands alternately until 60 inch pounds torque is attained.



| MODEL NUMBER | PIPE SIZE | CARTON QUANTITY | PALLET QUANTITY | LIST PRICE, Each Piece |
|--------------|---------------------------------------|-----------------|-----------------|------------------------|
| MI-SEW-T4 | 4" PL lateral to 6.27" - 15 3/4" main | 4 | 200 | \$45.75 |
| MI-SEW-T6 | 6" PL lateral to 8.16" - 21 1/4" main | 4 | 200 | \$57.00 |
| MI-SEW-W4 | 4" PL lateral to 6.27" - 15 3/4" main | 4 | 200 | \$45.75 |
| MI-SEW-W6 | 6" PL lateral to 8.16" - 21 1/4" main | 4 | 200 | \$57.00 |

CROSS REFERENCE

| MIFAB | ANACO | FERNCO | HUSKY | MISSION | PASCO |
|-----------|-------|--------|-------|------------------|-------|
| MI-SEW-T4 | - | TST-4 | - | TF-400 | 57144 |
| MI-SEW-T6 | - | TST-6 | - | TF-600 | 57166 |
| MI-SEW-W4 | - | TSW-4 | - | 4" WYE (1404649) | 57244 |
| MI-SEW-W6 | - | TSW-4 | - | 6" WYE (1406644) | 57266 |

CALIFORNIA PROPOSITION 65 WARNING. This product contains chemicals known to the State of California to cause cancer and birth defects or other reproductive harm.

Design and dimensions are subject to modification. Prices do not include applicable taxes. Visit www.mifab.com for the most recent product information.

MIFAB®, Inc., 1321 West 119th Street, Chicago, Illinois 60643-5109, USA

All sales subject to MIFAB's Terms and Warranties. Please refer to page 3.

Toll Free: 1-800-465-2736, Fax: 1-773-341-3049

sales@mifab.com • Canada Toll Free: 1-800-387-3880

POG-TP GASKETS TO CONNECT P-TRAPS TO PVC AND COPPER WASTE LINES

POG-TP-1
1 1/2" PVC Waste (DWV)
Line to 1 1/2" Tubular



POG-TP-2
2" Copper Waste (DWV) Line to 1 1/2" Tubular. Also works
with 2" PVC Waste (DWV) Line to 1 1/2" Tubular



POG-TP-3
1 1/2" PVC Waste Line
(DWV) Line to 1 1/4" Tubular



POG-TP-4
1 1/2" Copper Waste
(DWV) to 1 1/4" Tubular

| MODEL NUMBER | DESCRIPTION | CARTON QUANTITY | LIST PRICE, Each Piece |
|-----------------|--|-----------------|------------------------|
| POG-TP-1 | Connects 1 1/2" PVC Waste Line (DWV) to 1 1/2" Tubular P-Trap. | 100 | \$6.50 |
| POG-TP-2 | Connects 2" Copper Waste Line (DWV) to 1 1/2" Tubular P-Trap; also connects with 2" PVC Waste Line to 1 1/2" Tubular P-Trap. | 100 | \$7.75 |
| POG-TP-3 | Connects 1 1/2" PVC Waste Line (DWV) to 1 1/4" Tubular P-Trap. | 100 | \$8.75 |
| POG-TP-4 | Connects 1 1/2" Copper Waste Line (DWV) to 1 1/4" Tubular P-Trap. | 100 | \$8.75 |

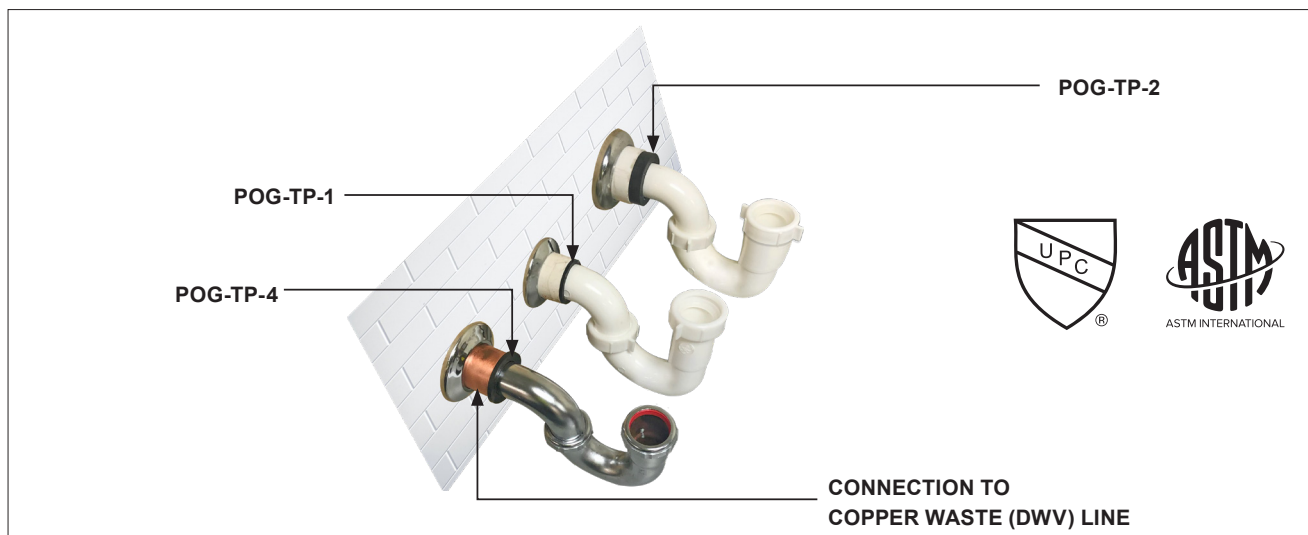

CALIFORNIA PROPOSITION 65 WARNING. This product contains chemicals known to the State of California to cause cancer and birth defects or other reproductive harm.

Location: _____



MI-HUB / MI-QHUB NO HUB COUPLINGS



Specification: MIFAB® Series MI-HUB / MI-QHUB (specify size) shielded no hub couplings are manufactured with gaskets made with neoprene that meets the requirements of ASTM C-564 housed inside a Type 301 stainless steel corrugated shield. Two (1 1/2" through 4" size), four (6" through 10" size) or six (12" sizes) Type 301 stainless steel clamps tightened with 5/16" Type 305 stainless steel hex head screws surround the shield to provide the sealing force. MI-HUB / MI-QHUB Series Couplings are tested and certified to the ASTM # C1277, # C1460, CISPI 310, CSA B602 (File # 247608) and B70 Standards. They are listed with IAPMO and NSF certified CISPI 310. Also tested and certified by Intertek Testing Services to CAN/ULC S102.2 "Smoke Test."

Function: Used to provide a positive and significant seal between no hub cast iron pipe and fittings.

Material Specifications:

- Bands** - Type 301 AISI stainless steel (Minimum tensile 165,000 psi).
- Eyelets** - Type 301 AISI stainless steel.
- Gasket** - Neoprene - meeting the requirements of ASTM C-564. Oil Immersion test: 80% Max. Volume.
- Screw Housing** - Type 304 AISI stainless steel.
- Screws** - Type 305 AISI stainless steel, 5/16" Hex head / Shoulder.
- Shield** - Type 301 AISI stainless.

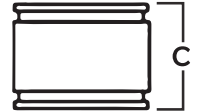

Performance Specifications:

- Requires a 5/16" hex head driver to tighten bolts to 60 inch lbs. minimum torque.
- * The MIFAB MI-HUB / MI-QHUB no hub couplings are also tested and certified to the ASTM C1460 Standard to connect cast iron pipe to PVC / ABS pipe in the 1 1/2", 2", 3", 4", 5", 6" and 8" sizes.



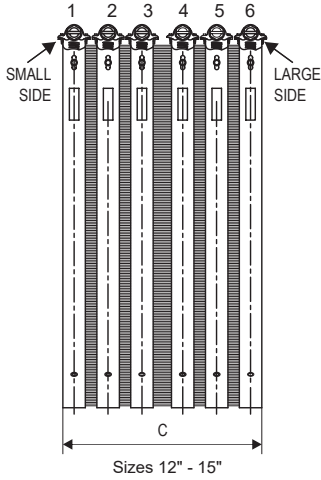

Sizes 12" - 15"

For couplings with six bands, tighten 3-2-1-4-5-6 alternately until minimum 60 inch lbs. of torque is attained for each band.

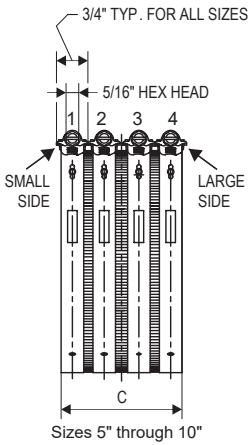

Sizes 5" through 10"

For couplings with four bands, tighten 2-3-1-4 alternately until minimum 60 inch lbs. of torque is attained for each band.

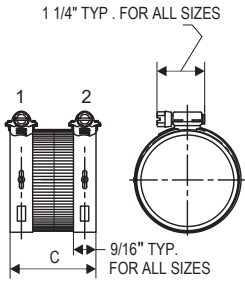

Sizes 1 1/2\" through 4"

For couplings with two bands, tighten 1-2 alternately until minimum 60 inch lbs. of torque is attained for each band.

| MODEL NUMBER | PIPE SIZE (NOMINAL DIA.) | (C) HEIGHT | INSTALLATION TORQUE (IN. - LBS) | ASTM C1277 HYDROSTATIC PRESSURE REQUIREMENT | NUMBER OF CLAMPS PER COUPLING | BAND WIDTH (CLAMP) |
|--------------------------|--------------------------|------------|---------------------------------|---|-------------------------------|--------------------|
| MI-HUB-150 / MI-QHUB-150 | 1 1/2" | 2 1/8" | 60 | 20 psi | 2 | 9/16" |
| MI-HUB-2150 | 2" x 1 1/2" | 2 1/8" | 60 | 20 psi | 2 | 9/16" |
| MI-HUB-2 / MI-QHUB-2 | 2" | 2 1/8" | 60 | 20 psi | 2 | 9/16" |
| MI-HUB-3 / MI-QHUB-3 | 3" | 2 1/8" | 60 | 20 psi | 2 | 9/16" |
| MI-HUB-32 | 3" x 2" | 2 1/8" | 60 | 20 psi | 2 | 9/16" |
| MI-HUB-4 / MI-QHUB-4 | 4" | 2 1/8" | 60 | 20 psi | 2 | 9/16" |
| MI-HUB-42 | 4" x 2" | 2 1/8" | 60 | 20 psi | 2 | 9/16" |
| MI-HUB-43 | 4" x 3" | 2 1/8" | 60 | 20 psi | 2 | 9/16" |
| MI-HUB-5 / MI-QHUB-5 | 5" | 3" | 60 | 20 psi | 4 | 9/16" |
| MI-HUB-6 / MI-QHUB-6 | 6" | 3" | 60 | 10 psi | 4 | 9/16" |
| MI-HUB-8 / MI-QHUB-8 | 8" | 4" | 60 | 6 psi | 4 | 9/16" |
| MI-HUB-10 / MI-QHUB-10 | 10" | 4" | 60 | 6 psi | 4 | 9/16" |
| MI-HUB-12 / MI-QHUB-12 | 12" | 5.43" | 60 | 6 psi | 6 | 9/16" |
| MI-HUB-15 / MI-QHUB-15 | 15" | 5.43" | 60 | 6 psi | 6 | 9/16" |

CALIFORNIA PROPOSITION 65 WARNING. This product contains chemicals known to the State of California to cause cancer and birth defects or other reproductive harm.

Design and dimensions are subject to modification. Prices do not include applicable taxes. Visit www.mifab.com for the most recent product information.

MIFAB®, Inc., 1321 West 119th Street, Chicago, Illinois 60643-5109, USA
All sales subject to MIFAB's Terms and Warranties. Please refer to page 3.

Toll Free: 1-800-465-2736, Fax: 1-773-341-3049
sales@mifab.com • Canada Toll Free: 1-800-387-3880

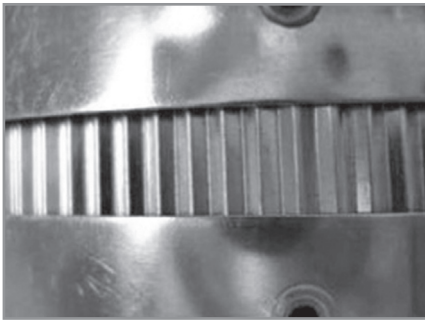
MIFAB MI-HUB / MI-QHUB NO HUB COUPLINGS FEATURES AND BENEFITS

1) STAINLESS STEEL SHIELD

A corrugated stainless steel shield provides a solid surface for the bands to tighten against to ensure a uniform grip around the pipe / fittings.

2) MECHANICAL INTERLOCKING CLAMP DESIGN

A one piece stainless steel screw housing mechanically interlocks the housing to the stainless steel band. This one piece housing eliminates leak paths that can develop with welded or staked clamps.

3) FLOATING EYELET DESIGN

The stainless steel clamp bands can move independently from the corrugated stainless steel shield. This independence prevents the shield from crimping during tightening which can lead to leaks.



"We brought Mifab couplings into our inventory and have been very happy with them. Great Price Point, and readily available."

– John Kozel, WinSupply, Ontario, CA

4) 5/16" HEX HEAD SCREW

The stainless steel 5/16" hex head screw is engineered to accept minimum 60 inch pounds of installation torque to ensure a secure band / shield assembly around the pipe / fittings.

5) FORMED GASKET DESIGN

The gasket is designed to form fit around the pipe and the inside of the shield so that when the clamping forces are applied, a superior sealing pressure and holding power is achieved. MIFAB's gaskets are made from neoprene which meets the requirements of ASTM C564.

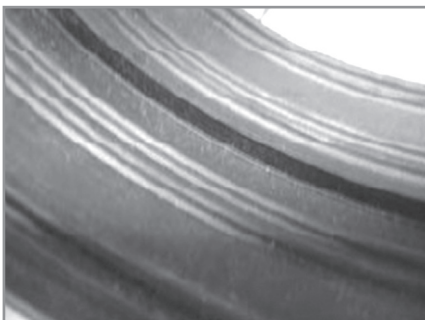
6) APPROVALS

MIFAB's MI-HUB / MI-QHUB Series of no hub couplings are tested and certified to the following Standards:

ASTM C-564, ASTM #C1277-2018, CISPI 310-2010, CSA B602-2010 and B70 and CAN/ULC S102.2-07 "Smoke Test."

They are also listed with I.A.P.M.O.

They are NSF Certified to the CISPI 310 Standard.

CALIFORNIA PROPOSITION 65 WARNING. This product contains chemicals known to the State of California to cause cancer and birth defects or other reproductive harm.

MIFAB MI-HUB / MI-QHUB NO HUB COUPLINGS INSTALLATION INSTRUCTIONS

The following installation instructions provide guidelines for joining MIFAB's MI-HUB / MI-QHUB Series of shielded no hub couplings to no hub pipe and fittings in accordance with standard industry practice.

Note that each City, State, Province or Region may have governing codes, engineering requirements and local practices of the plumbing trade that must be followed.

A correctly calibrated torque wrench set at minimum 60 inch pounds should always be used when installing MIFAB's no hub couplings. If power tools are used, they should be calibrated to torque only to 60 inch pounds.

- 1) Ensure that the pipe ends are cut square.
- 2) Place the neoprene gasket onto the end of one piece of pipe / fitting and the stainless steel clamp assembly over the other piece of pipe / fitting to be joined.
- 3) Place the second piece of pipe end into gasket, firmly placing both ends against the rib or shoulder in the center of the gasket.
- 4) Ensure that the pipe / fittings to be joined are aligned, then slide the loose coupling over the gasket so that the gasket is completely covered.

"Our largest multi-family contractors have had huge success with the MI-HUB NSF approved standard no hub couplings. We now have multiple wholesalers buying direct containers and the success has anchored us closer to these massive contractors.

The MI-HUB NSF couplings are being installed in volume in the City of Oakland. Oakland has the toughest municipal addendum to the California State Plumbing Code to prohibit cheap import untested couplings. We have earned their support through quality manufacturing and NSF compliance testing.

MIFAB's MI-XHUB couplings have been tested to the tough FM-1680 Standard. These couplings go in clean, fast and without any issues."

- Corey Kliman, owner, Kliman Sales, San Jose, CA

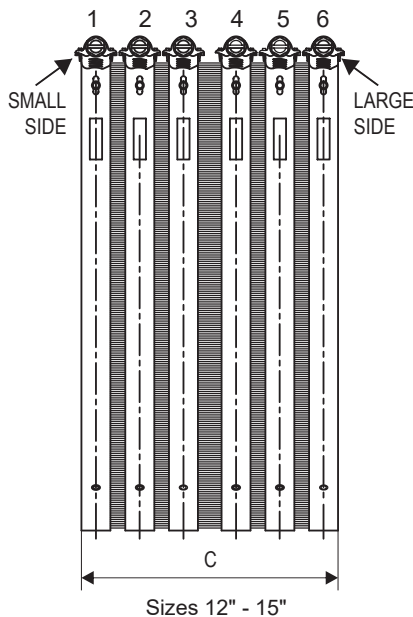

For couplings with six bands, tighten 3-2-1-4-5-6 alternately until minimum 60 inch lbs. of torque is attained for each band.

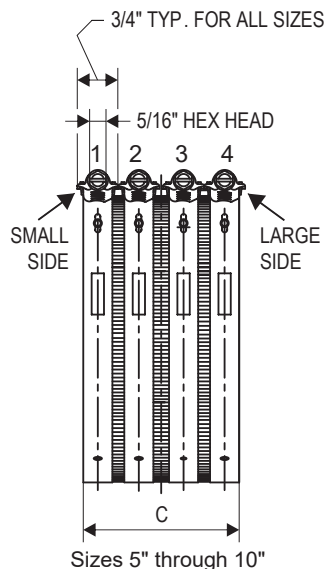

For couplings with four bands, tighten 2-3-1-4 alternately until minimum 60 inch lbs. of torque is attained for each band.

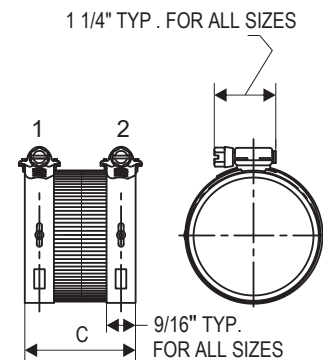

For couplings with two bands, tighten 1-2 alternately until minimum 60 inch lbs. of torque is attained for each band.

CALIFORNIA PROPOSITION 65 WARNING. This product contains chemicals known to the State of California to cause cancer and birth defects or other reproductive harm.

Design and dimensions are subject to modification. Prices do not include applicable taxes. Visit www.mifab.com for the most recent product information.

MIFAB®, Inc., 1321 West 119th Street, Chicago, Illinois 60643-5109, USA
All sales subject to MIFAB's Terms and Warranties. Please refer to page 3.

Toll Free: 1-800-465-2736, Fax: 1-773-341-3049
sales@mifab.com • Canada Toll Free: 1-800-387-3880

IAPMO RESEARCH AND TESTING, INC.

5001 E. Philadelphia Street, Ontario, CA 91761 • Phone (909) 472-4100 • Fax (909) 472-4244 • www.iapmort.org



CERTIFICATE OF LISTING

IAPMO R&T Product Listing

This IAPMO R&T Listing is current as of February 1, 2025

File Number : 5226

Issued To : MIFAB, INC.
1321 WEST 119TH STREET CHICAGO, IL, United States

Product : Hubless Cast Iron Pipe Couplings Products are in compliance with the following code(s):

- Uniform Plumbing Code (UPC®)
- National Plumbing Code of Canada
- International Plumbing Code (IPC®)

Products are in compliance with the following standard(s)

ASTM C1277-2018 (excluding Annex A1) and CSA B602

Identification: Gasket shall be marked with raised letters with pipe size, country of origin, manufacturer's name or trademark, "C564", and "CSA B602" with latest revision. The band of coupling shall be marked with the pipe size. The screw housing shall be marked with manufacturer's name or trademark, country of origin and the words "ALL STAINLESS" or "ALL SS". The coupling assembly shall also be permanently marked with the pipe material for which the coupling is designed. The gasket and bands shall also bear the cUPC® certification mark.

Characteristics: An elastomeric coupling and 300 series stainless steel shield & bands for use in joining hubless cast iron soil pipe and fittings in drainage, waste and vent systems. To be installed with IAPMO listed pipe and fittings and in accordance with the manufacturer's instructions and the requirements of the latest edition of the Uniform Plumbing Code. Products listed on this certificate have been tested by an IAPMO R&T recognized laboratory. This recognition has been granted based upon the laboratory's compliance to the applicable requirements of ISO/IEC 17025.

- | | | |
|------------|------------|-------------|
| MI-HUB-1.5 | MI-HUB-4 | MI-QHUB-150 |
| MI-HUB-10 | MI-HUB-4X3 | MI-QHUB-2 |
| MI-HUB-12 | MI-HUB-5 | MI-QHUB-3 |
| MI-HUB-15 | MI-HUB-6 | MI-QHUB-4 |
| MI-HUB-2 | MI-HUB-8 | MI-QHUB-5 |
| MI-HUB-3 | | MI-QHUB-6 |
| MI-HUB-3X2 | | MI-QHUB-8 |
| | | MI-QHUB-10 |
| | | MI-QHUB-12 |

David McHenry
Chairman, Product Certification Committee

Russ Chaney
CEO, The IAPMO Group



This listing period is based upon the last date of the month indicated on the Effective Date and Void After Date shown above. Any change in material, manufacturing process, marking or design without having first obtained the approval of the Product Certification Committee, or any evidence of non-compliance with applicable codes and standards or of inferior workmanship, may be deemed sufficient cause for revocation of this listing. Production of or reference to this form for advertising purposes may be made only by specific written permission of IAPMO Research and Testing, Inc. Any alteration of this certificate could be grounds for revocation of the listing. This document shall be reproduced in its entirety.

CALIFORNIA PROPOSITION 65 WARNING. This product contains chemicals known to the State of California to cause cancer and birth defects or other reproductive harm.



Certificate of Compliance

Certificate: 2199383

Master Contract: 247608

Project: 2199383

Date Issued: November 17, 2011

MIFAB, Inc.
1321 West 119th St
Chicago, IL 60643
USA

Attention: Mr. Mike Whiteside

The products listed below are eligible to bear the CSA Mark shown

Issued by: Kelly Yaremko

PRODUCTS

CLASS – 7021 01 PIPE AND PIPE FITTINGS Mechanical Joints (Non-Transition Type)

CLASS – 7021 02 PIPE AND PIPE FITTINGS Mechanical Coupling

Mechanical Joint (MJ) couplings, for use with plain-end cast iron soil pipe and pipe fittings: Same size pipe fittings; 1-1/2, 2, 3, 4, 5, 6, 8, 10 inch. Reduced size pipe fittings; 2 x 1-1/2, 3 x 2, 4 x 3, 4 x 2 inch.

APPLICABLE REQUIREMENTS

CSA Standard CSA-B70-02 Cast Iron Soil Pipe, Fittings and Means of Joining

CSA Standard CSA-B602-05 Mechanical Couplings for Drain, Waste, and Vent Pipe and Sewer Pipe

MARKINGS

Submittor's name and/or CSA file number 247608, model designation and the CSA Mark appear in a permanent manner on each unit.

O:\ML\247608-2199383.doc

CALIFORNIA PROPOSITION 65 WARNING. This product contains chemicals known to the State of California to cause cancer and birth defects or other reproductive harm.

Design and dimensions are subject to modification. Prices do not include applicable taxes. Visit www.mifab.com for the most recent product information.

MIFAB®, Inc., 1321 West 119th Street, Chicago, Illinois 60643-5109, USA

Toll Free: 1-800-465-2736, Fax: 1-773-341-3049

All sales subject to MIFAB's Terms and Warranties. Please refer to page 3.

sales@mifab.com • Canada Toll Free: 1-800-387-3880



Supplement to Certificate of Compliance

Certificate: 2199383

Master Contract: 247608

The products listed, including the latest revision described below, are eligible to be marked in accordance with the referenced Certificate.

Product Certification History

| Project | Date | Description |
|---------|--------------|---|
| 2475972 | Nov 17, 2011 | Update report to update Applicable Requirements |
| 2199383 | Aug 6, 2009 | Original Certification. |
| | | Listee |
| | | MIFAB |
| | | 247608 |
| | | MI-HUB-150 MI-QHUB-150 |
| | | MI-HUB-2 MI-QHUB-2 |
| | | MI-HUB-3 MI-QHUB-3 |
| | | MI-HUB-4 MI-QHUB-4 |
| | | MI-HUB-5 MI-QHUB-5 |
| | | MI-HUB-6 MI-QHUB-6 |
| | | MI-HUB-8 MI-QHUB-8 |
| | | MI-HUB-10 |
| | | MI-HUB-2150 |
| | | MI-HUB-32 |
| | | MI-HUB-43 |
| | | MI-HUB-42 |

"MIFAB's transition couplings are a great quality product for the money plus having a local rep's stock almost in our backyard makes it easy to pick up the One Off odd balls."

– Allan Pollock, REX Pipe & Supply, Lorain, Ohio

DQD 507 Rev. 2004-06-30

CALIFORNIA PROPOSITION 65 WARNING. This product contains chemicals known to the State of California to cause cancer and birth defects or other reproductive harm.

Location: _____



MI-XHUB / MI-QXHUB

HEAVY DUTY NO HUB COUPLINGS



Specification: MIFAB® Series MI-XHUB / MI-QXHUB (specify size) heavy duty shielded no hub couplings are manufactured with gaskets made from neoprene that meets the requirements of ASTM C-564 housed inside a Type 304 stainless steel corrugated shield. Four (1 1/2" through 4" size), six (5" through 15" size) Type 304 stainless steel clamps tightened with 3/8" Type 305 stainless steel hex head screws surround the shield to provide the sealing force. MI-XHUB / MI-QXHUB Series Couplings are tested and certified to the ASTM # C1540, # C1460, and CSA B602 Standards and are listed with IAPMO. The MI-XHUB / MI-QXHUB are also tested and certified by Intertek Testing Services to the CAN/ULC S102.2 "Smoke Test". The MI-XHUB / MI-QXHUB are tested by I.A.P.M.O. to comply to the FM 1680-1989 Standard (except for markings).

Function: Used to provide a positive and significant seal between no hub cast iron pipe and fittings.

MATERIAL SPECIFICATIONS:

- Bands** - Type 304 AISI stainless steel (Minimum tensile 165,000 psi).
- Eyelets** - Type 304 AISI stainless steel.
- Gasket** - Neoprene - meeting the requirements of ASTM C-564. Oil Immersion test: 80% Max. Volume.
- Screw Housing** - Type 304 AISI stainless steel.
- Screws** - Type 305 AISI stainless steel, 3/8" Hex head / Shoulder.
- Shield** - Type 304 AISI stainless steel painted red for easy identification.



The MIFAB MI-XHUB / MI-QXHUB no hub couplings are also tested and certified to the ASTM C1460 Standard to connect cast iron pipe to PVC / ABS pipe in the 1 1/2", 2", 3", 4", 5", 6" and 8" sizes.

MIFAB's 5"-15" heavy duty no hub couplings have six sealing bands. Tighten the bands 3-2-1-4-5-6 alternately, until minimum 80 inch pounds of torque is attained for each one.

MIFAB's 1 1/2", 2", 3" and 4" heavy duty no hub couplings with four sealing bands, Tighten the bands 2-3-1-4 alternately, until minimum 80 inch pounds of torque is attained for each one.

| MODEL NUMBER | PIPE SIZE (NOMINAL DIA.) | (C) HEIGHT | INSTALLATION TORQUE (IN. - LBS) | ASTM C1540 HYDROSTATIC PRESSURE REQUIREMENT | NUMBER OF CLAMPS PER COUPLING | (W) BAND WIDTH CLAMP |
|----------------------------|--------------------------|------------|---------------------------------|---|-------------------------------|----------------------|
| MI-XHUB-150 / MI-QXHUB-150 | 1 1/2" | 3" | 80 | 30 psi | 4 | 9/16" |
| MI-XHUB-2 / MI-QXHUB-2 | 2" | 3" | 80 | 30 psi | 4 | 9/16" |
| MI-XHUB-3 / MI-QXHUB-3 | 3" | 3" | 80 | 30 psi | 4 | 29/64" |
| MI-XHUB-32 | 3" x 2" | 3" | 80 | 30 psi | 4 | 29/64" |
| MI-XHUB-4 / MI-QXHUB-4 | 4" | 3" | 80 | 30 psi | 4 | 9/16" |
| MI-XHUB-42 | 4" x 2" | 3" | 80 | 30 psi | 4 | 9/16" |
| MI-XHUB-43 | 4" x 3" | 3" | 80 | 30 psi | 4 | 9/16" |
| MI-XHUB-5 / MI-QXHUB-5 | 5" | 4" | 80 | 30 psi | 6 | 9/16" |
| MI-XHUB-6 / MI-QXHUB-6 | 6" | 4" | 80 | 27 psi | 6 | 9/16" |
| MI-XHUB-8 / MI-QXHUB-8 | 8" | 4" | 80 | 15 psi | 6 | 9/16" |
| MI-XHUB-10 / MI-QXHUB-10 | 10" | 4" | 80 | 9 psi | 6 | 9/16" |
| MI-XHUB-12 / MI-QXHUB-12 | 12" | 5.43" | 80 | 6 psi | 6 | 5/8" |
| MI-XHUB-15 / MI-QXHUB-15 | 15" | 5.43" | 80 | 6 psi | 6 | 5/8" |

CALIFORNIA PROPOSITION 65 WARNING. This product contains chemicals known to the State of California to cause cancer and birth defects or other reproductive harm.

Design and dimensions are subject to modification. Prices do not include applicable taxes. Visit www.mifab.com for the most recent product information.

MIFAB®, Inc., 1321 West 119th Street, Chicago, Illinois 60643-5109, USA
 All sales subject to MIFAB®'s Terms and Warranties. Please refer to page 3.

Toll Free: 1-800-465-2736, Fax: 1-773-341-3049
 sales@mifab.com • Canada Toll Free: 1-800-387-3880

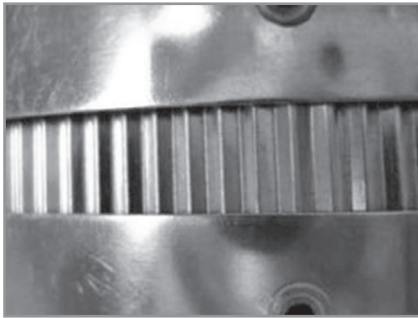
MIFAB MI-XHUB / MI-QXHUB NO HUB COUPLINGS FEATURES & BENEFITS

1) RED SHIELD

A distinctive red stainless steel shield easily identifies MIFAB's heavy duty MI-XHUB / MI-QXHUB no hub couplings.

2) MECHANICAL INTERLOCKING CLAMP DESIGN

A one piece stainless steel screw housing mechanically interlocks the housing to the stainless steel band. This one piece housing eliminates leak paths that can develop with welded or staked clamps.

3) FLOATING EYELET DESIGN

The stainless steel clamp bands can move independently from the corrugated stainless steel shield. This independence prevents the shield from crimping during tightening which can lead to leaks.

"I don't even have to think about it. I consider MIFAB to be our partner, not merely our vendor."

– Tom Babcock, Kast Marketing, Chicago, IL

4) 3/8" HEX HEAD SCREW

The stainless steel 3/8" hex head screw is engineered to accept minimum 80 inch pounds of installation torque to ensure a secure band / shield assembly around the pipe / fittings.

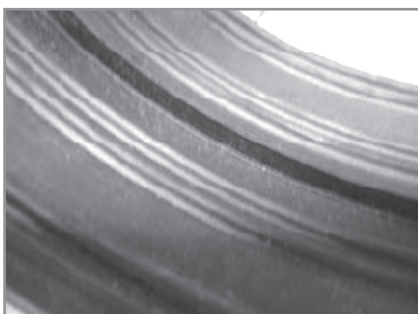
5) FORMED GASKET DESIGN

The gasket is designed to form fit around the pipe and the inside of the shield so that when the clamping forces are applied, a superior sealing pressure and holding power is achieved. MIFAB's gaskets are made from neoprene which meets the requirements of ASTM C564.

6) APPROVALS

MIFAB's MI-XHUB / MI-QXHUB Series of no hub couplings are tested and certified to the following Standards:

ASTM #C564, ASTM #C1540 and CSA B602 and are also listed with I.A.P.M.O. The MI-XHUB are also tested and certified by Intertek Testing Services to the CAN/ULC S102.2 "Smoke Test". The MI-XHUB / MI-QXHUB are tested by I.A.P.M.O. to comply to the FM 1680 Standard (except for markings).

CALIFORNIA PROPOSITION 65 WARNING. This product contains chemicals known to the State of California to cause cancer and birth defects or other reproductive harm.

MIFAB MI-XHUB / MI-QXHUB COUPLINGS INSTALLATION INSTRUCTIONS

The following installation instructions provide guidelines for joining MIFAB's MI-XHUB / MI-QXHUB Series of shielded no hub couplings to no hub pipe and fittings in accordance with standard industry practice.

Note that each City, State, Province or Region may have governing codes, engineering requirements and local practices of the plumbing trade that must be followed.

A correctly calibrated torque wrench set at 80 inch pounds should always be used when installing MIFAB's no hub couplings. If power tools are used, they should be calibrated to torque only to minimum 80 inch pounds.

- 1) Ensure that the pipe ends are cut square.
- 2) Place the neoprene gasket onto the end of one piece of pipe / fitting and the stainless steel clamp assembly over the other piece of pipe / fitting to be joined.
- 3) Place the second piece of pipe end into gasket, firmly placing both ends against the rib or shoulder in the center of the gasket.
- 4) Ensure that the pipe / fittings to be joined are aligned, then slide the loose coupling over the gasket so that the gasket is completely covered.

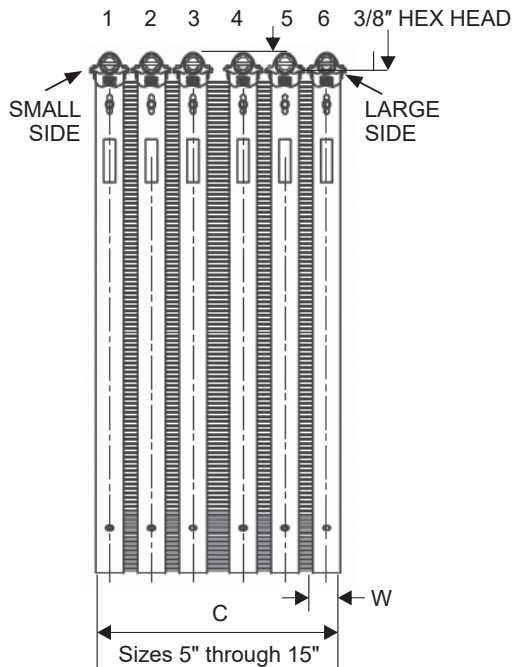

MIFAB's 5"-15" heavy duty no hub couplings have six sealing bands. Tighten the bands 3-2-1-4-5-6 alternately, until minimum 80 inch pounds of torque is attained for each one.

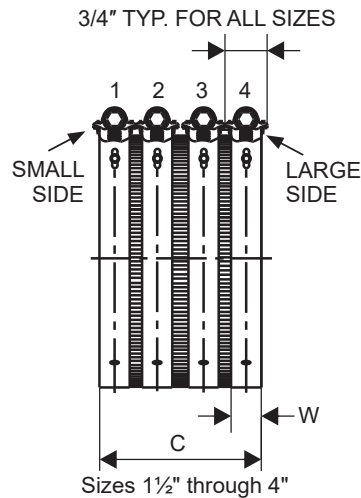

MIFAB's 1 1/2", 2", 3" and 4" heavy duty no hub couplings with four sealing bands, Tighten the bands 2-3-1-4 alternately, until minimum 80 inch pounds of torque is attained for each one.

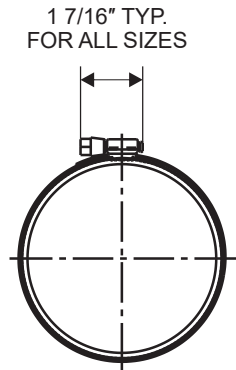

"My favorite thing about MIFAB is the great people. They are wonderful starting with the Owner, the Sales Managers and right on down the line."
 – Dan Thomas, Ben Thomas and Associates, Shade Gap, PA

CALIFORNIA PROPOSITION 65 WARNING. This product contains chemicals known to the State of California to cause cancer and birth defects or other reproductive harm.

Design and dimensions are subject to modification. Prices do not include applicable taxes. Visit www.mifab.com for the most recent product information.

MIFAB®, Inc., 1321 West 119th Street, Chicago, Illinois 60643-5109, USA

All sales subject to MIFAB's Terms and Warranties. Please refer to page 3.

Toll Free: 1-800-465-2736, Fax: 1-773-341-3049

sales@mifab.com • Canada Toll Free: 1-800-387-3880

IAPMO RESEARCH AND TESTING, INC.

5001 E. Philadelphia Street, Ontario, CA 91761 • Phone (909) 472-4100 • Fax (909) 472-4244 • www.iapmort.org



CERTIFICATE OF LISTING

IAPMO R&T Product Listing

This IAPMO R&T Listing is current as of February 1, 2025

File Number : 5225

 Issued To : MIFAB, INC.
 1321 WEST 119TH STREET CHICAGO, IL, United States

 Product : Heavy Duty Shielded Couplings Joining Hubless Cast Iron Soil Pipe and Fittings
 Products are in compliance with the following code(s):

- Uniform Plumbing Code (UPC®)
- National Plumbing Code of Canada
- International Plumbing Code (IPC®)

Products are in compliance with the following standard(s)

ASTM C1540-2018 (excluding Annex A1) and CSA B602

Identification: Each clamp assembly shall be permanently marked with the manufacturer's name or U.S. registered trademark, the country of origin, "all stainless" and the pipe size for which it is designed. Gaskets shall be marked with the manufacturer's name or symbol, the pipe size and material and class (such as NH, SV, XH), the year of manufacture, country of origin and the ASTM specification designation. Each major component shall be permanently marked with "CSA B602". The product shall also bear the cUPC® certification mark.

Characteristics: Heavy Duty Shielded Couplings to be installed in accordance with the manufacturer's instructions and the latest edition of the Uniform Plumbing Code. Products listed on this certificate have been tested by an IAPMO R&T recognized laboratory. This recognition has been granted based upon the laboratory's compliance to the applicable requirements of ISO/IEC 17025.

| Model Number | | DESCRIPTION |
|---------------|-------------|---------------|
| *MI-QXHUB-1.5 | MI-XHUB-1.5 | Size: 1-1/2" |
| *MI-QXHUB-2 | MI-XHUB-2 | Size: 2" |
| *MI-QXHUB-3 | MI-XHUB-3 | Size: 3" |
| *MI-QXHUB-4 | MI-XHUB-4 | Size: 4" |
| *MI-QXHUB-5 | | Size: 5" |
| *MI-QXHUB-6 | MI-XHUB-6 | Size: 6" |
| *MI-QXHUB-8 | MI-XHUB-8 | Size: 8" |
| *MI-QXHUB-10 | MI-XHUB-10 | Size: 10" |
| *MI-QXHUB-12 | MI-XHUB-12 | Size: 12" |
| *MI-QXHUB-15 | MI-XHUB-15 | Size: 15" |
| | MI-XHUB-3X2 | Size: 3" x 2" |
| | MI-XHUB-4X3 | Size: 4" x 3" |

David McHenry
 Chairman, Product Certification Committee

Russ Chaney
 CEO, The IAPMO Group



This listing period is based upon the last date of the month indicated on the Effective Date and Void After Date shown above. Any change in material, manufacturing process, marking or design without having first obtained the approval of the Product Certification Committee, or any evidence of non-compliance with applicable codes and standards or of inferior workmanship, may be deemed sufficient cause for revocation of this listing. Production of or reference to this form for advertising purposes may be made only by specific written permission of IAPMO Research and Testing, Inc. Any alteration of this certificate could be grounds for revocation of the listing. This document shall be reproduced in its entirety.

CALIFORNIA PROPOSITION 65 WARNING. This product contains chemicals known to the State of California to cause cancer and birth defects or other reproductive harm.

TEST REPORT



Ph: 909.472.4100 • Fax 909.472.4243 • Web: www.iapmo.org
5001 East Philadelphia Street • Ontario, California 91761-2816 - USA

Report Number: 321-11031 Project No.: 18826

Report Issued: June 8, 2011

Client: Mifab
1321 West 119th street
Chicago, IL 60643
Contact: Michael Whiteside

Source of Samples: The samples were shipped by the manufacturer, and received by IAPMO R&T Lab in good condition on March 31, 2011.

Date of Testing: April 08, 2011 to June 8, 2011

Sample Description: Heavy Duty Hubless Couplings

Model nos: MI-XHUB-150, MI-XHUB-2, MI-XHUB-3, MI-XHUB- 4", MI-XHUB-5, MI-XHUB-6, MI-XHUB-8 and MI-XHUB-10.

Each unit consisted of a rubber gasket, a corrugated stainless steel shield, and stainless steel bands / clamp assembly.

Scope of Testing: The purpose of the testing was to determine if the samples tested of the hubless couplings met the applicable requirements of FM 1680-1989, entitled "Approval Standard for Couplings Used in Hubless Cast Iron Systems for Drain, Waste or Vent, Sewer, Rainwater or Storm Drain Systems Above and Below Ground, Industrial/Commercial and Residential".

Conclusion: The samples tested of the heavy duty hubless couplings models shown above, from Mifab, complied with all the applicable requirements of FM 1680-1989, Except for 4.1 Markings.

By our signatures below, we certify that all the testing and sample preparation for this report was performed under continuous, direct supervision of IAPMO R&T Lab, unless otherwise noted.

Tested by:

Reviewed by:



Hanks Ninh, Project Engineer

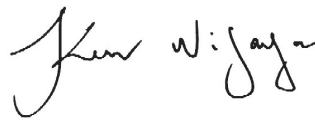

Ken Wijaya, Sr. Laboratory Director

REGULAR DUTY (MI-HUB / MI-QHUB) VS. HEAVY DUTY (MI-XHUB / MI-QXHUB) NO HUB COUPLINGS

MIFAB's Series of MI-HUB / MI-QHUB and MI-XHUB / MI-QXHUB no hub couplings are designed and engineered to connect cast iron pipe and fittings together. MIFAB's flexible stainless steel shield provides adjustability to the installing contractor when working with cast iron pipe and fittings that are over or undersized to ensure a quality system and labor savings.

MIFAB's MI-HUB / MI-QHUB Series is a "regular duty" no hub coupling tested and certified to the ASTM #C1277, ASTM #C564, CISPI 310 and CSA B602 Standards and are listed with IAPMO and NSF certified to CISPI 310. They are also tested by Intertek Testing Services to CAN / ULC S102.2 "smoke test".

Storm and Sanitary drainage systems are generally considered to be "low pressure" systems under normal conditions. This changes when a blockage in the line occurs and the resulting build up of water can greatly increase the pressure within the system.

High pressures can also occur in plumbing systems when lower level parking garages and multistory lobbies are built. Often, the design of these structures does not allow for relief in the sanitary systems for four floors or more. The condition known as "Hydraulic Jump" can lead to surges and pressure at any change of direction; especially at the base of the stack. Storm systems have even a greater risk of high line pressure occurrences since they are often not relieved for the total height of the structure.

Underground piping systems have different issues and risks not found above ground. Movement of the earth during back filling and settling of trench beddings is common. In addition, areas of seismic activity, unstable soil conditions caused by thermal effects (expansion and contraction), environments of high corrosion and high groundwater tables can lead to separation of joints without visibility to the installer.

Failure of the piping system due to high line pressures and faulty underground installations can lead to pipes leaking /breaking at their joints. The resulting water leaks can cause damage within the building, affecting equipment, furniture, machinery and the building structure. Plumbing Engineers should consider specifying MIFAB's "heavy duty" no hub couplings to minimize these risks.

MIFAB's MI-XHUB / MI-QXHUB Series is a "heavy duty" no hub coupling tested and certified to the ASTM #C1540, ASTM #C564 and CSA B602 Standards and listed with IAPMO. The MI-XHUB / MI-QXHUB Series has also been tested by IAPMO to the FM1680 Standard (except for markings).

The MI-XHUB / MI-QXHUB Series provides a more rigid joint connection than the MI-HUB / MI-QHUB Series because it has a wider shield and a greater number of stainless steel clamps. These additional clamps, which need to be torqued to 80/100 inch pounds, make a more uniformly rigid joint with the load supported at the outer edges of the coupling and the centerline of the joint. The additional clamps also increase the surface bearing contact between the coupling and the pipe / fittings to reduce joint movement at high internal line pressures. In comparison, the industry's "regular duty" no hub couplings have two fewer clamps and are torqued only to 60 inch pounds.

MIFAB's MI-XHUB / MI-QXHUB Series of heavy duty no hub couplings is the specifier's ideal choice for the most demanding conditions.

"I feel comfortable calling MIFAB to ask for advice and assistance."

– Joe Ficek, Grumman Butkus Consulting Engineers, Chicago, IL

CALIFORNIA PROPOSITION 65 WARNING. This product contains chemicals known to the State of California to cause cancer and birth defects or other reproductive harm.

REQUIRED USE OF HANGERS AND SUPPORTS

To ensure optimum performance of a no hub cast iron pipe and fittings connected with MIFAB's no hub couplings, please consider the following:

1. UNDERGROUND INSTALLATIONS:

No hub cast iron pipe in trenches should be continuously supported on undisturbed earth, compacted fill or on masonry blocks at each joint connection. The line and grade of the pipe must be correct. Each vertical unsupported branch of pipe must be securely staked in order to maintain stability during backfilling and pouring of concrete. The pipe should be stabilized in the correct position by partial backfilling and cradling to ensure the proper alignment during backfilling. Ensure that large rocks and / or other large objects are not dropped into the trench on top of the piping system.

2. VERTICAL PIPE INSTALLATIONS:

No hub cast iron pipe and fittings installed vertically should be secured with floor clamps at each stack base and at each story height or at intervals close enough to maintain system alignment.

3. HORIZONTAL PIPE INSTALLATIONS:

No hub cast iron pipe and fittings installed horizontally should have pipe hangers installed per the local plumbing code to ensure proper alignment and grade to prevent shear. Horizontal piping should be supported at five foot intervals except that pipe exceeding five feet in length may be supported at ten foot intervals. Hangers should be installed at each horizontal branch connection. Hangers and supports should be installed within 18" of the no hub coupling. The bases of cast iron stacks should be supported on concrete, on brick laid in cement, by metal brackets attached to the building or by local plumbing code approved installations. Large diameter pipe (six inches and larger) should be braced at changes of direction to prevent horizontal movement.

Closet bends, traparms, traps and other branches should be securely supported by a clevis type hanger, strapping or cradled underneath by earth and secured above by a suitable material to provide a firm contact between the pipe and the building in order to prevent movement in any direction and to ensure the stability of the piping system.

Note: All pipe connections should be made and supported in accordance to local plumbing codes.

CALIFORNIA PROPOSITION 65 WARNING. This product contains chemicals known to the State of California to cause cancer and birth defects or other reproductive harm.

Design and dimensions are subject to modification. Prices do not include applicable taxes. Visit www.mifab.com for the most recent product information.

MIFAB[®], Inc., 1321 West 119th Street, Chicago, Illinois 60643-5109, USA

All sales subject to MIFAB's Terms and Warranties. Please refer to page 3.

Toll Free: 1-800-465-2736, Fax: 1-773-341-3049

sales@mifab.com • Canada Toll Free: 1-800-387-3880

TESTING AND INSPECTION OF NO HUB COUPLINGS

It is important to test all cast iron piping installations for leaks after the roughing in has been completed. Before testing, the installer should notify the inspector of the local administrative authority having jurisdiction over plumbing installations. Leave concealed work uncovered until the required tests are performed and the system receives approval.

Note: In all installations, installers should be aware of local conditions, codes and regulations. Comply with all local codes, regulations, manufacturers' instructions and architect engineer specifications.

WATER OR HYDROSTATIC TESTING:

This is the most common type of test used to test a completed cast iron soil pipe installation, and it is the test most often recommended by plumbing codes. Its purpose is to check the installation for leaks and to correct these prior to putting the system into service. Use the following steps to perform a water test: (Note: MIFAB does not recommend an air test)

1. Since visual inspection of the system is required, conduct this test prior to enclosing above ground installations, or backfilling below-ground installations.
2. Isolate each floor or section being tested by inserting plugs into the test tees in the stacks.
3. Plug or cap all other openings with test plugs or test caps.
4. Fill the system with water at its highest point. Do this slowly to allow any trapped air to escape as the water level rises.
Note: Failure to remove entrapped air may cause faulty test results, so be sure all entrapped air has been removed to obtain reliable test results.
5. As water fills a vertical pipe, it creates hydrostatic pressure. This pressure increases as the height of the water in the vertical pipe increases. MIFAB[®] recommends water testing with ten feet of hydrostatic pressure (4.3 pounds per square inch).
6. After filling the stack to ten feet of head, visually inspect the section you are testing for any leaks around its joints with: the no hub couplings.
7. In hubless systems, leaks can often be traced to no hub couplings that were not tightened properly to the recommended torque and / or with the correct tools such as a calibrated torque wrench. In these cases, correctly tightening the couplings should eliminate the leak.
8. Water test each portion of the system for 15 minutes. This is sufficient time for any problems to be detected.
9. After a successful test, drain the system and prepare the next section for testing.

CALIFORNIA PROPOSITION 65 WARNING. This product contains chemicals known to the State of California to cause cancer and birth defects or other reproductive harm.



Quick Hub

No Hub Couplings



One and Done.

Fastest installation on the market fits easily and effortlessly onto pipe and fittings. No need to roll gasket, remove shield or waste time fumbling with a loose shield.

With Quick Hub there is no need to remove the gasket first and roll it over the pipe.

The patented hourglass shape design ensures the gasket remains within the shield during shipping and handling and allows the Quick Hub to be easily pushed onto the pipe.

US PATENT #10,100,956 US PATENT #10,253,885 US PATENT #10,557,578

Features

- **40 % less labor**
- **Less skilled labor helper required**
- **Gasket and shield do not come apart**
- **Faster installation**
Complete job quicker to make deadlines
- **Quick Install**
No need to peel back gasket and shield
- **Fast Assembly**
Assembles over cast iron fitting with ease
- **Neoprene Material**
Tested and certified to ASTM C1277, C1SP1 310 compliant, IAPMO listed
- **Torque Requirements**
Same 60-80 lb. torque requirement as regular couplings
- **Field Tested**
Tested on high-rise commercial buildings. Tested to perform on min/max pipe diameters
- **Three Sealing Rings**
Three sealing rings vs. two from others for better sealing performance.

• **Cast Iron To PVC - Transition**

The regular and heavy duty Quick Hub sizes 1 1/2", 2", 3", 4", 5", 6" and 8" are third party tested & certified to the ASTM C1460 Standard. They can be used to connect Cast Iron pipe to Plastic, Steel or Extra Heavy Cast Iron pipe.



WWW.MIFAB.COM

CALIFORNIA PROPOSITION 65 WARNING. This product contains chemicals known to the State of California to cause cancer and birth defects or other reproductive harm.

Design and dimensions are subject to modification. Prices do not include applicable taxes. Visit www.mifab.com for the most recent product information.

MIFAB®, Inc., 1321 West 119th Street, Chicago, Illinois 60643-5109, USA
All sales subject to MIFAB's Terms and Warranties. Please refer to page 3.

Toll Free: 1-800-465-2736, Fax: 1-773-341-3049
sales@mifab.com • Canada Toll Free: 1-800-387-3880

QUICK HUB – TIME SAVINGS STUDIES

A major plumbing contractor in Atlanta, GA (Batchelor and Kimball) did a time trial using the MIFAB 2" – 4" Quick Hub couplings. It took them 15 seconds to install each Quick Hub vs. 2 minutes each for regular design couplings from others.

A major plumbing contractor in New Orleans, LA (Marino and Son Plumbing) said that they "estimate 42 cast iron joints / day when figuring labor time to install no hub couplings onto cast iron pipe and thought that they could do 90 joints a day with MIFAB's Quick Hub couplings."

Material cost is a fixed cost.

Labor cost is a variable cost.

Take advantage of the 40% labor savings with MIFAB's Quick Hub couplings to get off your project faster and have less risk when estimating the labor hours for coupling installation.

Project Name: "Pinnacle on the Park", San Diego, CA

The project is two twin towers 53 floors high, one tower consisting 478 living units the other tower 489 units (both towers have 45 floors of living space or units). The location of the towers is "15th and Island" in downtown San Diego (the towers are two of the tallest buildings in San Diego). There are 2 inch and 3 inch Quick Hub couplings installed and tested on the 44th floor. Below is a photo of the General Foreman installing Quick Hub couplings. Collins Plumbing, La Mesa, CA.



CALIFORNIA PROPOSITION 65 WARNING. This product contains chemicals known to the State of California to cause cancer and birth defects or other reproductive harm.

MIFAB CATALOGS



**MPB-2025-USA
SPECIFICATION DRAINAGE
PRODUCTS
(LIT-067)**



**CLPB-2025
LIGHT COMMERCIAL
PRODUCTS
(LIT-048)**



**AD-2025-USA
ACCESS DOORS
(LIT-043)**



**BEECO-2025
BACKFLOW PREVENTERS,
PRESSURE REDUCING VALVES,
AND ACCESSORIES
(LIT-071)**



**NH-2025
NO HUB COUPLINGS
(LIT-044)**



**TDCP-2025
POLYMER CONCRETE
TRENCH DRAINS
(LIT-076)**



**TD-2025
GRP AND STEEL
TRENCH DRAINS
(LIT-046)**



**TDS-2025
SHOWER DRAINS
(LIT-077)**



**TDSS-2025
STAINLESS STEEL
TRENCH DRAINS
(LIT-072)**



**ROOFGUARD-2020
ROOFGUARD
ROOF DOME
(LIT-058)**



**C-PORT-2023
ROOFTOP RUBBER
PIPE SUPPORTS
(LIT-047)**



**DB-2025
DIALYSIS BOXES
(LIT-070)**

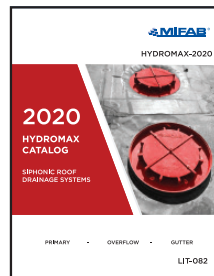

**HYDROMAX-2020
SIPHONIC DRAINAGE
(LIT-082)**



**INT-2025
INTERCEPTORS & ACID
NEUTRALIZATION TANKS
(LIT-095)**



**TSP-2024
TRAP SEAL PRIMERS
(LIT-062)**



CALIFORNIA PROPOSITION 65 WARNING. This product contains chemicals known to the State of California to cause cancer and birth defects or other reproductive harm.

Design and dimensions are subject to modification. Prices do not include applicable taxes. Visit www.mifab.com for the most recent product information.

MIFAB®, Inc., 1321 West 119th Street, Chicago, Illinois 60643-5109, USA

All sales subject to MIFAB's Terms and Warranties. Please refer to page 3.

Toll Free: 1-800-465-2736, Fax: 1-773-341-3049

sales@mifab.com • Canada Toll Free: 1-800-387-3880



NH-2025

COUPLINGS CATALOG 2025

**NO HUB, FLEXIBLE AND
TRANSITION COUPLINGS AND
ACCESSORIES**



QUICK HUB

-

HEAVY DUTY

-

FLEXIBLE

LIT-044