

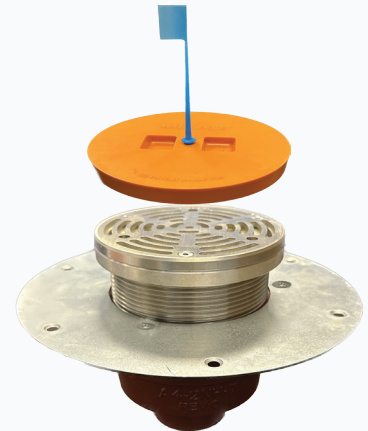

**CLPB-2025**

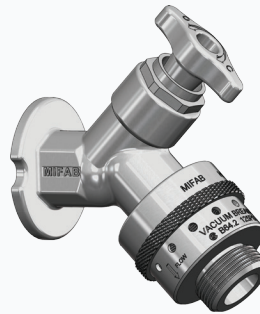





































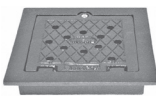













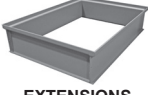







# CLPB CATALOG 2025

**LIGHT COMMERCIAL  
DRAINAGE PRODUCTS**

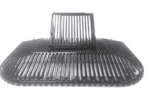

**LIT-048**

**PICTORIAL INDEX**

 <b>F100-TS</b> (Pages 4, 5)	 <b>F220-TS</b> (Page 4)	 <b>CRTS5-1</b> (Page 5)	 <b>F220-TS-WF</b> (Page 6)	 <b>C220-TOS</b> (Page 7)	 <b>C220-TOS-WF</b> (Page 7)
 <b>F220</b> (Page 8)	 <b>F220-S</b> (Page 8)	 <b>F100</b> (Page 9)	 <b>F100-S</b> (Page 9)	 <b>F100-C</b> (Page 10)	 <b>F100-C-S</b> (Page 10)
 <b>F300</b> (Page 11)	 <b>F320</b> (Page 11)	 <b>C220-R</b> (Page 12)	 <b>C220-S</b> (Page 12)	 <b>DRAIN TOP - ROUND</b> (Page 13)	 <b>DRAIN TOP - SQUARE</b> (Page 13)
 <b>DRAIN BODIES</b> (Page 13)	 <b>ALLSTAR® COVER</b> (Page 35)	 <b>SD7000</b> (Page 14)	 <b>SD7002-S4</b> (Page 14)	 <b>FD212TC-49</b> (Page 14)	 <b>FD230-WF</b> (Page 15)
 <b>FLOOR DRAIN OPTIONS</b> (Page 16)	 <b>50-SD-TC</b> (Page 16)	 <b>FD-960</b> (Page 16)	 <b>F650</b> (Page 16)	 <b>SW6P-4</b> (Page 16)	 <b>R150</b> (Page 17)
 <b>C300</b> (Page 17)	 <b>CLOSET FLANGES</b> (Page 18)	 <b>MI-CONN</b> (Page 18)	 <b>MI-SCOV</b> (Page 18)	 <b>RFD</b> (Page 18)	 <b>TEST PLUGS</b> (Page 19)
 <b>DIELECTRIC NIPPLES</b> (Page 19)	 <b>R1800</b> (Page 19)	 <b>PVC FLOOR SINKS</b> (Page 20)	 <b>CAST IRON FLOOR SINKS</b> (Page 21)	 <b>MCL-G</b> (Page 22)	 <b>MCL-G-L</b> (Page 23)
 <b>EXTENSIONS</b> (Pages 23, 25)	 <b>MI-ROC</b> (Page 24)	 <b>MI-GO</b> (Page 25)	 <b>HY-1000-NPB</b> (Page 27)	 <b>HY-2000-NPB</b> (Page 27)	 <b>HY-3000-NPB</b> (Page 27)
 <b>HY-3500-NPB</b> (Page 27)	 <b>HY-4000-NPB</b> (Page 28)	 <b>HY-4500-NPB</b> (Page 28)	 <b>HY-5000-NPB</b> (Page 28)	 <b>HY-5500-NPB</b> (Page 28)	 <b>HY-6000-NPB</b> (Page 29)
 <b>HY-5800</b> (Page 29)	 <b>HY-9000-NPB</b> (Page 30)	 <b>HY-9200-NPB</b> (Page 30)	 <b>HYDRANT BOXES</b> (Page 31)	 <b>MI-TR TRANSITION PVC COUPLING</b> (Page 32)	 <b>RoofGuard - RG2016DD</b> (Page 33)
 <b>GLOVES</b> (Page 34)	<b>PROJECT REFERENCES</b> (Page 37-38)	<b>CROSS REFERENCE GUIDE</b> (Pages 39-42)	<p><i>"The Allstar covers are great. We use them on our monolithic pours."</i></p> <p style="text-align: right;">- MSD Mechanical, Toronto, Canada</p>		

CALIFORNIA PROPOSITION 65 WARNING. This product contains chemicals known to the State of California to cause cancer and birth defects or other reproductive harm.

## TABLE OF CONTENTS

	DISCOUNT		DISCOUNT
Allstar Cover.....	35	Hydrants .....	27-31
Area Drains .....	11, 15	Membrane Clamp Lockdown Clamps .....	19
Cleanouts .....	12, 17	Replacement Roof Drain.....	18
Cleanouts, Top Set.....	7	Roof Drains .....	17, 18
Closet Flanges .....	18	RoofGuard.....	33
Cross Reference Guide .....	39-42	Sewer Box Sewer Lid & Cover.....	18
Deck Drains .....	11, 15, 16	Shower Drains.....	4-6, 8-10, 14-16
Dielectric Nipples .....	19	Shower Sub Drains .....	16
Floor Drains.....	4-6, 8-11, 13-16	Sidewalk Boxes .....	16
Floor Drains, Top Set .....	4-6	Snap In Grates .....	16
Floor Sinks .....	20-21	Cast iron connection fitting for decks .....	18
Gloves .....	34	Test Plugs.....	19
Grease Interceptors .....	22-26	Wood Deck Floor Drains.....	15, 16
		Transition PVC Coupling.....	32

## TERMS AND WARRANTIES

### WHOLESALE DISCOUNT:

Contact MIFAB® or your local representative for your applicable discount structure.

**FREIGHT ALLOWANCE:** Ex Works, MIFAB's Chicago, Illinois Factory or Manufacturer Representative's warehouse with full motor freight allowed on shipments of \$3,500.00 Net or more, within the continental U.S.A. and Canada, except Alaska, Hawaii and Puerto Rico. MIFAB reserves the right to choose the carrier and route of shipment. Alaska: Ex Works, Seattle, WA. Hawaii: Freight allowed on shipments of \$3,500.00 or more only when shipped from West Coast, U.S. Puerto Rico: Ex Works, Miami, Florida. There is no allowance for United Parcel Service, Federal Express or Shipment by air service. Full motor freight is allowed on shipments of \$3,500.00 Net or more, within the continental U.S.A. and Canada for any combination of BEECO, Counterline, No Hub Coupling, Trench Drain, Access Door and Trap Seal Primer products. Shipping dates are estimates and time of delivery is not the essence of the sale of the contract. Therefore, under no circumstances will MIFAB® have any responsibility on account of any delays in manufacture, transportation, or otherwise. Additional freight services such as construction site delivery, lift gate delivery service, re-consigned freight or notification charges, are not included in full freight allowance terms, and will result in additional freight charges.

**QUOTATION TERMS:** List Price and discount protected for 30 days from date issued by MIFAB®. Orders received within this period must be released for shipment within 30 days from date of purchase order, otherwise, prices will be those that are in effect at the time of shipment.

**PAYMENT TERMS:** Terms of payment are Net 30 days from the date of the invoice. All pricing in United States currency except for sales to Canadian customers which are priced in Canadian dollars. The Buyer shall pay all sales, consumers, and / or any other applicable taxes. Past due accounts will be subject to a 2% per month service charge from the date of the invoice. If any proceedings be instructed by or against Buyer under any bankruptcy or insolvency law, or if Buyer shall fail to make timely payment on this or any other order, or if, in MIFAB's judgment, Buyer's financial situation justifies such action, MIFAB® may, at its election, require payment in advance or cancel the order as to any unshipped item and require payment of its reasonable cancellation charges. If Buyer delays completion of manufacture, MIFAB® may elect to require payment according to percentage of completion. Equipment held for Buyer shall be at Buyer's risk and expense. In all cases, regardless of partial payment, title to the Products shall remain with MIFAB® until payment for the Products (including any notes given therefore) has been made in full. Should legal action be necessary to enforce payment of an unpaid invoice, the Buyer will assume full responsibility for any court costs and reasonable attorney fees. All orders subject to credit check and approval prior to shipment. Confirmed irrevocable letter of credit or cash in advance of shipment is required for accounts without an established line of credit. Minimum invoice amount is \$100.00. MIFAB® reserves the right to apply a minimum order charge to equal \$100.00. MIFAB's Accounting Department must be notified of potential pricing errors within 30 days of the invoice date. Any terms and conditions stated on Buyer's orders which are inconsistent with MIFAB's quotation and Terms and Warranties shall be of no effect.

**RETURNED GOODS RESTOCKING CHARGE:** Standard product may be returned within a one year period only with written permission from MIFAB®. All products in catalog are not considered Standard. Standard product to be determined by MIFAB®. Returned goods are subject to a 25% restocking charge, plus cost of reconditioning, if necessary, to make material saleable. Material must be returned to MIFAB® freight prepaid only after written permission from MIFAB® to accept the returned material. Buyer must provide copy of the original invoice on which the material was charged. The original outgoing freight cost to ship the order will be deducted from the credit. Credit allowance will be in the form of merchandise credit only-not cash credit which must be used within 12 months of the date of issue. The value of a return must total \$100.00 to qualify for credit allowance. No credit will be allowed for auxiliary tappings, discontinued, or made to order items. Products designated non stock and / or that have been specially made are not subject to return or cancellation.

**LIMITED WARRANTY:** MIFAB® warrants each product against defects in material and workmanship for a period of one year from the date of original shipment. In the event of such defects within the warranty period, MIFAB® will, at its option, replace or recondition the product without charge. This shall constitute the exclusive remedy for breach of warranty, and MIFAB® shall not be responsible for any incidental or consequential damages, including, without limitation, damages or other costs resulting from labor charges, delays, vandalism, negligence, fouling caused by foreign material, damage from adverse water conditions, chemicals, or any other circumstances over which MIFAB® has no control. This warranty shall be invalidated by any abuse, misuse, misapplication or improper installation of the product.

**MIFAB® MAKES NO OTHER WARRANTIES EXPRESSED OR IMPLIED AS PROVIDED IN THIS LIMITED WARRANTY.**

**ILLUSTRATIONS OR TYPICAL INSTALLATIONS:** The typical installations for various products in each product section are intended to illustrate the products and their options. Under no circumstances are they to be construed as recommended installation procedures. Consult local codes and project specifications for proper installation instructions.

**ALL SALES SUBJECT TO MIFAB's TERMS AND WARRANTIES.**

**NOTE:** Prices and terms are subject to change without notice and supersede all previous quotations. The right is reserved to change or modify product design or construction without prior notice and without incurring any obligation to make similar changes and modifications to product previously or subsequently sold. Contact MIFAB® for any clarification.

CONTENTS © MIFAB® INC. Copyright 2025

CALIFORNIA PROPOSITION 65 WARNING. This product contains chemicals known to the State of California to cause cancer and birth defects or other reproductive harm.

Design and dimensions are subject to modification. Prices do not include applicable taxes.

Visit [www.mifab.com](http://www.mifab.com) for the most recent product information.

MIFAB®, Inc., 1321 West 119th Street, Chicago, Illinois 60643-5109, USA

Toll Free: 1-800-465-2736, Fax: 1-773-341-3049

All sales subject to MIFAB's® Terms and Warranties. Please refer to page 3.

sales@mifab.com Canada Toll Free: 1-800-387-3880

**COUNTERLINE F220-TS TOP SET ROUND DOUBLE ADJUSTABLE FLOOR DRAIN WITH COVER**

Double adjustable Floor Drain with no anchor flange for slab on grade installations and round strainer. 1/2" Trap Seal Primer tapping and plastic cover included with all bodies.

**F220-30-TS**

PATENT #  
9,453,331

**F220-TS**

MODEL #	OUTLET SIZE	STRAINER DIAMETER & MATERIAL	LIST PRICE
F222P-TS5-1 or -3	2" Push On (Cast Iron)	5" Round, Nickel Bronze (-1) or Stainless Steel (-3)	\$142.00
F223P-TS5-1 or -3	3" Push On (Cast Iron)	5" Round, Nickel Bronze (-1) or Stainless Steel (-3)	\$142.00
F224P-TS5-1 or -3	4" Push On (Cast Iron)	5" Round, Nickel Bronze (-1) or Stainless Steel (-3)	\$142.00
F222P-TS6-1 or -3	2" Push On (Cast Iron)	6" Round, Nickel Bronze (-1) or Stainless Steel (-3)	\$168.00
F223P-TS6-1 or -3	3" Push On (Cast Iron)	6" Round, Nickel Bronze (-1) or Stainless Steel (-3)	\$168.00
F224P-TS6-1 or -3	4" Push On (Cast Iron)	6" Round, Nickel Bronze (-1) or Stainless Steel (-3)	\$168.00

MODEL #	OUTLET SIZE	STRAINER DIAMETER & MATERIAL	LIST PRICE
F222-30-TS5-1 or -3	2" PVC socket	5" Round, Nickel Bronze (-1) or Stainless Steel (-3)	\$71.00
F223-30-TS5-1 or -3	3" PVC socket	5" Round, Nickel Bronze (-1) or Stainless Steel (-3)	\$71.00
F224-30-TS5-1 or -3	4" PVC socket	5" Round, Nickel Bronze (-1) or Stainless Steel (-3)	\$71.00
F222-30-TS6-1 or -3	2" PVC socket	6" Round, Nickel Bronze (-1) or Stainless Steel (-3)	\$94.00
F223-30-TS6-1 or -3	3" PVC socket	6" Round, Nickel Bronze (-1) or Stainless Steel (-3)	\$94.00
F224-30-TS6-1 or -3	4" PVC socket	6" Round, Nickel Bronze (-1) or Stainless Steel (-3)	\$94.00
F222-31-TS5-1 or -3	2" ABS socket	5" Round, Nickel Bronze (-1) or Stainless Steel (-3)	\$71.00
F223-31-TS5-1 or -3	3" ABS socket	5" Round, Nickel Bronze (-1) or Stainless Steel (-3)	\$71.00
F224-31-TS5-1 or -3	4" ABS socket	5" Round, Nickel Bronze (-1) or Stainless Steel (-3)	\$71.00
F222-31-TS6-1 or -3	2" ABS socket	6" Round, Nickel Bronze (-1) or Stainless Steel (-3)	\$94.00
F223-31-TS6-1 or -3	3" ABS socket	6" Round, Nickel Bronze (-1) or Stainless Steel (-3)	\$94.00
F224-31-TS6-1 or -3	4" ABS socket	6" Round, Nickel Bronze (-1) or Stainless Steel (-3)	\$94.00
F222-TS5-1 or -3	2" No Hub (Cast Iron)	5" Round, Nickel Bronze (-1) or Stainless Steel (-3)	\$142.00
F223-TS5-1 or -3	3" No Hub (Cast Iron)	5" Round, Nickel Bronze (-1) or Stainless Steel (-3)	\$142.00
F224-TS5-1 or -3	4" No Hub (Cast Iron)	5" Round, Nickel Bronze (-1) or Stainless Steel (-3)	\$142.00
F222-TS6-1 or -3	2" No Hub (Cast Iron)	6" Round, Nickel Bronze (-1) or Stainless Steel (-3)	\$168.00
F223-TS6-1 or -3	3" No Hub (Cast Iron)	6" Round, Nickel Bronze (-1) or Stainless Steel (-3)	\$168.00
F224-TS6-1 or -3	4" No Hub (Cast Iron)	6" Round, Nickel Bronze (-1) or Stainless Steel (-3)	\$168.00

OPTIONAL VARIATIONS		
SUFFIX	DESCRIPTION	LIST PRICE
-5	Sediment Bucket (A1-PB)	\$37.25
-6	Vandal Proof (H-1039A - 3 pieces)	\$8.50
-15	2" Cast Iron Extension Adapter	\$59.25

7" and 8" Nickel Bronze (-1) and Stainless Steel (-3) round Top Set strainers are available. Replace TS5 in the model number with TS7 or TS8 and add \$35.00 List to the TS6 List Price for the TS7 add \$95.00 List to the TS6 List Price for the TS8.

**COUNTERLINE F100-TS TOP SET ROUND DOUBLE ADJUSTABLE FLOOR DRAIN w/FLANGE & COVER**

Double adjustable Floor Drain with anchor flange and round strainer. 1/2" Trap Seal Primer tapping and plastic cover included with all bodies.

**F100-30-TS**

PATENT #  
9,453,331

**F100-TS**

MODEL #	OUTLET SIZE	STRAINER DIAMETER & MATERIAL	LIST PRICE
F102P-TS5-1 or -3	2" Push On (Cast Iron)	5" Round, Nickel Bronze (-1) or Stainless Steel (-3)	\$112.00
F103P-TS5-1 or -3	3" Push On (Cast Iron)	5" Round, Nickel Bronze (-1) or Stainless Steel (-3)	\$112.00
F104P-TS5-1 or -3	4" Push On (Cast Iron)	5" Round, Nickel Bronze (-1) or Stainless Steel (-3)	\$112.00
F102P-TS6-1 or -3	2" Push On (Cast Iron)	6" Round, Nickel Bronze (-1) or Stainless Steel (-3)	\$138.00
F103P-TS6-1 or -3	3" Push On (Cast Iron)	6" Round, Nickel Bronze (-1) or Stainless Steel (-3)	\$138.00
F104P-TS6-1 or -3	4" Push On (Cast Iron)	6" Round, Nickel Bronze (-1) or Stainless Steel (-3)	\$138.00

MODEL #	OUTLET SIZE	STRAINER DIAMETER & MATERIAL	LIST PRICE
F102-30-TS5-1 or -3	2" PVC socket	5" Round, Nickel Bronze (-1) or Stainless Steel (-3)	\$84.50
F103-30-TS5-1 or -3	3" PVC socket	5" Round, Nickel Bronze (-1) or Stainless Steel (-3)	\$84.50
F104-30-TS5-1 or -3	4" PVC socket	5" Round, Nickel Bronze (-1) or Stainless Steel (-3)	\$84.50
F102-30-TS6-1 or -3	2" PVC socket	6" Round, Nickel Bronze (-1) or Stainless Steel (-3)	\$102.00
F103-30-TS6-1 or -3	3" PVC socket	6" Round, Nickel Bronze (-1) or Stainless Steel (-3)	\$102.00
F104-30-TS6-1 or -3	4" PVC socket	6" Round, Nickel Bronze (-1) or Stainless Steel (-3)	\$102.00
F102-31-TS5-1 or -3	2" ABS socket	5" Round, Nickel Bronze (-1) or Stainless Steel (-3)	\$84.50
F103-31-TS5-1 or -3	3" ABS socket	5" Round, Nickel Bronze (-1) or Stainless Steel (-3)	\$84.50
F104-31-TS5-1 or -3	4" ABS socket	5" Round, Nickel Bronze (-1) or Stainless Steel (-3)	\$84.50
F102-31-TS6-1 or -3	2" ABS socket	6" Round, Nickel Bronze (-1) or Stainless Steel (-3)	\$102.00
F103-31-TS6-1 or -3	3" ABS socket	6" Round, Nickel Bronze (-1) or Stainless Steel (-3)	\$102.00
F104-31-TS6-1 or -3	4" ABS socket	6" Round, Nickel Bronze (-1) or Stainless Steel (-3)	\$102.00
F102-TS5-1 or -3	2" No Hub (Cast Iron)	5" Round, Nickel Bronze (-1) or Stainless Steel (-3)	\$112.00
F103-TS5-1 or -3	3" No Hub (Cast Iron)	5" Round, Nickel Bronze (-1) or Stainless Steel (-3)	\$112.00
F104-TS5-1 or -3	4" No Hub (Cast Iron)	5" Round, Nickel Bronze (-1) or Stainless Steel (-3)	\$112.00
F102-TS6-1 or -3	2" No Hub (Cast Iron)	6" Round, Nickel Bronze (-1) or Stainless Steel (-3)	\$138.00
F103-TS6-1 or -3	3" No Hub (Cast Iron)	6" Round, Nickel Bronze (-1) or Stainless Steel (-3)	\$138.00
F104-TS6-1 or -3	4" No Hub (Cast Iron)	6" Round, Nickel Bronze (-1) or Stainless Steel (-3)	\$138.00

OPTIONAL VARIATIONS		
SUFFIX	DESCRIPTION	LIST PRICE
-5	Sediment Bucket (A1-PB)	\$37.25
-6	Vandal Proof (H-1039A - 3 pieces)	\$8.50
-15	2" Cast Iron Extension Adapter	\$59.25

7" and 8" Nickel Bronze (-1) and Stainless Steel (-3) round Top Set strainers are available. Replace TS5 in the model number with TS7 or TS8 and add \$35.00 List to the TS6 List Price for the TS7 add \$95.00 List to the TS6 List Price for the TS8.

CALIFORNIA PROPOSITION 65 WARNING. This product contains chemicals known to the State of California to cause cancer and birth defects or other reproductive harm.

**COUNTERLINE F100-C-TS TOP SET ROUND DOUBLE ADJUSTABLE FLOOR DRAIN w/FLANGE, CLAMP & COVER**

MODEL #	OUTLET SIZE	STRAINER DIAMETER & MATERIAL	LIST PRICE
F102-30-C-TS5-1 or -3	2" PVC socket	5" Round, Nickel Bronze (-1) or Stainless Steel (-3)	\$95.50
F103-30-C-TS5-1 or -3	3" PVC socket	5" Round, Nickel Bronze (-1) or Stainless Steel (-3)	\$95.50
F104-30-C-TS5-1 or -3	4" PVC socket	5" Round, Nickel Bronze (-1) or Stainless Steel (-3)	\$95.50
F102-30-C-TS6-1 or -3	2" PVC socket	6" Round, Nickel Bronze (-1) or Stainless Steel (-3)	\$113.50
F103-30-C-TS6-1 or -3	3" PVC socket	6" Round, Nickel Bronze (-1) or Stainless Steel (-3)	\$113.50
F104-30-C-TS6-1 or -3	4" PVC socket	6" Round, Nickel Bronze (-1) or Stainless Steel (-3)	\$113.50
F102-31-C-TS5-1 or -3	2" ABS socket	5" Round, Nickel Bronze (-1) or Stainless Steel (-3)	\$95.50
F103-31-C-TS5-1 or -3	3" ABS socket	5" Round, Nickel Bronze (-1) or Stainless Steel (-3)	\$95.50
F104-31-C-TS5-1 or -3	4" ABS socket	5" Round, Nickel Bronze (-1) or Stainless Steel (-3)	\$95.50
F102-31-C-TS6-1 or -3	2" ABS socket	6" Round, Nickel Bronze (-1) or Stainless Steel (-3)	\$113.50
F103-31-C-TS6-1 or -3	3" ABS socket	6" Round, Nickel Bronze (-1) or Stainless Steel (-3)	\$113.50
F104-31-C-TS6-1 or -3	4" ABS socket	6" Round, Nickel Bronze (-1) or Stainless Steel (-3)	\$113.50
F102-C-TS5-1 or -3	2" No Hub (Cast Iron)	5" Round, Nickel Bronze (-1) or Stainless Steel (-3)	\$123.00
F103-C-TS5-1 or -3	3" No Hub (Cast Iron)	5" Round, Nickel Bronze (-1) or Stainless Steel (-3)	\$123.00
F104-C-TS5-1 or -3	4" No Hub (Cast Iron)	5" Round, Nickel Bronze (-1) or Stainless Steel (-3)	\$123.00
F102-C-TS6-1 or -3	2" No Hub (Cast Iron)	6" Round, Nickel Bronze (-1) or Stainless Steel (-3)	\$150.00
F103-C-TS6-1 or -3	3" No Hub (Cast Iron)	6" Round, Nickel Bronze (-1) or Stainless Steel (-3)	\$150.00
F104-C-TS6-1 or -3	4" No Hub (Cast Iron)	6" Round, Nickel Bronze (-1) or Stainless Steel (-3)	\$150.00

7" and 8" Nickel Bronze (-1) and Stainless Steel (-3) round Top Set strainers are available. Replace TS5 in the model number with TS7 or TS8 and add \$35.00 List to the TS6 List Price for the TS7 add \$95.00 List to the TS6 List Price for the TS8.

Double adjustable Floor Drain with anchor flange, membrane clamp and round strainer. 1/2" Trap Seal Primer tapping and plastic cover included with all bodies.

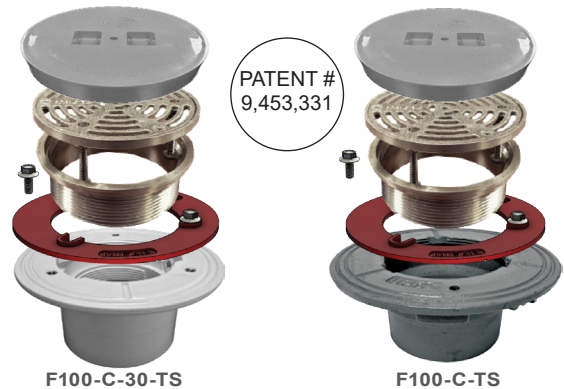

MODEL #	OUTLET SIZE	STRAINER DIAMETER & MATERIAL	LIST PRICE
F102P-C-TS5-1 or -3	2" Push On (Cast Iron)	5" Round, Nickel Bronze (-1) or Stainless Steel (-3)	\$123.00
F103P-C-TS5-1 or -3	3" Push On (Cast Iron)	5" Round, Nickel Bronze (-1) or Stainless Steel (-3)	\$123.00
F104P-C-TS5-1 or -3	4" Push On (Cast Iron)	5" Round, Nickel Bronze (-1) or Stainless Steel (-3)	\$123.00
F102P-C-TS6-1 or -3	2" Push On (Cast Iron)	6" Round, Nickel Bronze (-1) or Stainless Steel (-3)	\$150.00
F103P-C-TS6-1 or -3	3" Push On (Cast Iron)	6" Round, Nickel Bronze (-1) or Stainless Steel (-3)	\$150.00
F104P-C-TS6-1 or -3	4" Push On (Cast Iron)	6" Round, Nickel Bronze (-1) or Stainless Steel (-3)	\$150.00

OPTIONAL VARIATIONS		
SUFFIX	DESCRIPTION	LIST PRICE
-5	Sediment Bucket (A1-PB)	\$37.25
-6	Vandal Proof (H-1039A - 3 pieces)	\$8.50
-15	2" Cast Iron Extension Adapter	\$59.25

**COUNTERLINE CRTS5-1 TOP SET RETRO-FIT GRATE & FRAME**

MIFAB's CRTS5-1 retro-fit ring and grate is designed to be placed into any JaSaWaZ 5" round floor drain strainer. Simply remove the existing JaSaWaZ grate, place the CRTS-UR-1 universal ring into the recessed area of the strainer and connect it with the screws provided. The CRTS5-1 frame and grate can then be vertically adjusted and also adjusted side to side to meet the finished floor. Top Set retro-fit grate and frame product is also available to be placed into any JaSaWaZ (Josam, Jay R. Smith, Wade, Watts and Zurn) 6" round and 5" x 5" and 6" x 6" strainers.

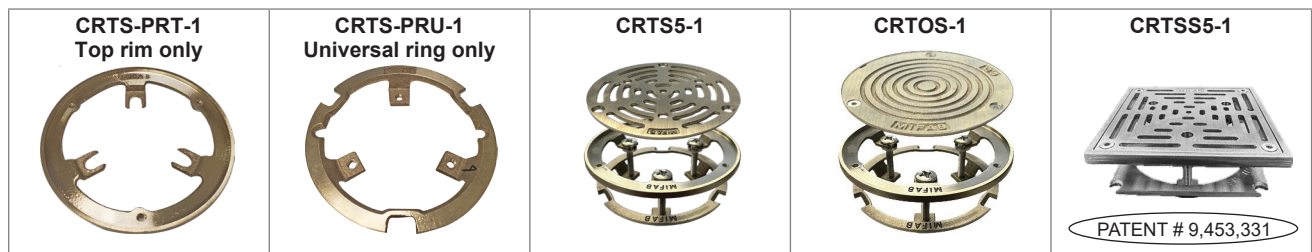

MODEL #	OUTLET SIZE	LIST PRICE
CRTS5-1 or -3	5" Diameter N.B. (-1) or S.S. (-3) retro-fit ring & grate	\$64.00
CRTS6-1 or -3	6" Diameter N.B. (-1) or S.S. (-3) retro-fit ring & grate	\$87.00
CRTSS5-1 or -3	5" x 5" N.B. (-1) or S.S. (-3) retro-fit ring & grate	\$90.00
CRTSS6-1 or -3	6" x 6" N.B. (-1) or S.S. (-3) retro-fit ring & grate	\$105.00
CRTOS-1 or -3	5" Diameter N.B. (-1) or S.S. (-3) retro-fit ring & cover	\$90.00

OPTIONAL VARIATIONS		
SUFFIX	DESCRIPTION	LIST PRICE
-6	Vandal Proof (H-1039A - 3 pieces)	\$8.50

**Note: Phillips screwdriver (P2) needed to adjust Top Set screws.**

CALIFORNIA PROPOSITION 65 WARNING. This product contains chemicals known to the State of California to cause cancer and birth defects or other reproductive harm.

Design and dimensions are subject to modification. Prices do not include applicable taxes.

Visit [www.mifab.com](http://www.mifab.com) for the most recent product information.

MIFAB®, Inc., 1321 West 119th Street, Chicago, Illinois 60643-5109, USA

Toll Free: 1-800-465-2736, Fax: 1-773-341-3049

All sales subject to MIFAB's® Terms and Warranties. Please refer to page 3.

sales@mifab.com Canada Toll Free: 1-800-387-3880

**COUNTERLINE F220-TS-WF**
**TOP SET ROUND DOUBLE ADJUSTABLE FLOOR DRAIN WITH WOOD DECK FLANGE & COVER FOR INSTALLING ON WOOD DECK FLOORS**

Double adjustable Floor Drain with no anchor flange for slab on grade installations and round strainer. 1/2" Trap Seal Primer tapping, plastic cover and wood deck flange included with all bodies.

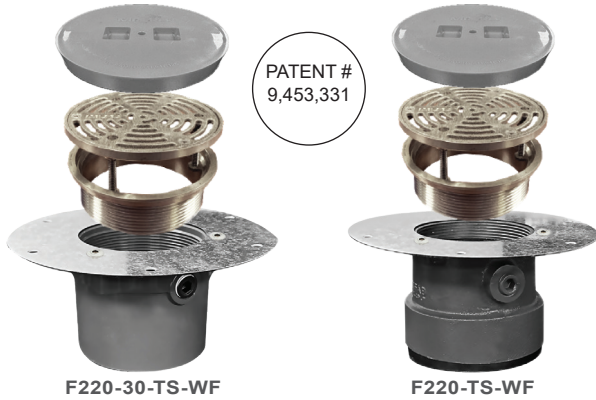

**F220-30-TS-WF**
**F220-TS-WF**

MODEL #	OUTLET SIZE	STRAINER DIAMETER & MATERIAL	LIST PRICE
F222P-TS5-WF-1 or -3	2" Push On (Cast Iron)	5" Round, Nickel Bronze (-1) or Stainless Steel (-3)	\$164.25
F223P-TS5-WF-1 or -3	3" Push On (Cast Iron)	5" Round, Nickel Bronze (-1) or Stainless Steel (-3)	\$164.25
F224P-TS5-WF-1 or -3	4" Push On (Cast Iron)	5" Round, Nickel Bronze (-1) or Stainless Steel (-3)	\$164.25
F222P-TS6-WF-1 or -3	2" Push On (Cast Iron)	6" Round, Nickel Bronze (-1) or Stainless Steel (-3)	\$191.00
F223P-TS6-WF-1 or -3	3" Push On (Cast Iron)	6" Round, Nickel Bronze (-1) or Stainless Steel (-3)	\$191.00
F224P-TS6-WF-1 or -3	4" Push On (Cast Iron)	6" Round, Nickel Bronze (-1) or Stainless Steel (-3)	\$191.00

MODEL #	OUTLET SIZE	STRAINER DIAMETER & MATERIAL	LIST PRICE
F222-30-TS5-WF-1 or -3	2" PVC socket	5" Round, Nickel Bronze (-1) or Stainless Steel (-3)	\$102.25
F223-30-TS5-WF-1 or -3	3" PVC socket	5" Round, Nickel Bronze (-1) or Stainless Steel (-3)	\$102.25
F224-30-TS5-WF-1 or -3	4" PVC socket	5" Round, Nickel Bronze (-1) or Stainless Steel (-3)	\$102.25
F222-30-TS6-WF-1 or -3	2" PVC socket	6" Round, Nickel Bronze (-1) or Stainless Steel (-3)	\$126.50
F223-30-TS6-WF-1 or -3	3" PVC socket	6" Round, Nickel Bronze (-1) or Stainless Steel (-3)	\$126.50
F224-30-TS6-WF-1 or -3	4" PVC socket	6" Round, Nickel Bronze (-1) or Stainless Steel (-3)	\$126.50
F222-31-TS5-WF-1 or -3	2" ABS socket	5" Round, Nickel Bronze (-1) or Stainless Steel (-3)	\$102.25
F223-31-TS5-WF-1 or -3	3" ABS socket	5" Round, Nickel Bronze (-1) or Stainless Steel (-3)	\$102.25
F224-31-TS5-WF-1 or -3	4" ABS socket	5" Round, Nickel Bronze (-1) or Stainless Steel (-3)	\$102.25
F222-31-TS6-WF-1 or -3	2" ABS socket	6" Round, Nickel Bronze (-1) or Stainless Steel (-3)	\$126.50
F223-31-TS6-WF-1 or -3	3" ABS socket	6" Round, Nickel Bronze (-1) or Stainless Steel (-3)	\$126.50
F224-31-TS6-WF-1 or -3	4" ABS socket	6" Round, Nickel Bronze (-1) or Stainless Steel (-3)	\$126.50
F222-TS5-WF-1 or -3	2" No Hub (Cast Iron)	5" Round, Nickel Bronze (-1) or Stainless Steel (-3)	\$164.25
F223-TS5-WF-1 or -3	3" No Hub (Cast Iron)	5" Round, Nickel Bronze (-1) or Stainless Steel (-3)	\$164.25
F224-TS5-WF-1 or -3	4" No Hub (Cast Iron)	5" Round, Nickel Bronze (-1) or Stainless Steel (-3)	\$164.25
F222-TS6-WF-1 or -3	2" No Hub (Cast Iron)	6" Round, Nickel Bronze (-1) or Stainless Steel (-3)	\$191.00
F223-TS6-WF-1 or -3	3" No Hub (Cast Iron)	6" Round, Nickel Bronze (-1) or Stainless Steel (-3)	\$191.00
F224-TS6-WF-1 or -3	4" No Hub (Cast Iron)	6" Round, Nickel Bronze (-1) or Stainless Steel (-3)	\$191.00

OPTIONAL VARIATIONS		
SUFFIX	DESCRIPTION	LIST PRICE
-5	Sediment Bucket (A1-PB)	\$37.25
-6	Vandal Proof (H-1039A - 3 pieces)	\$8.50
-15	2" Cast Iron Extension Adapter	\$59.25
-C	Membrane Clamp	\$18.00

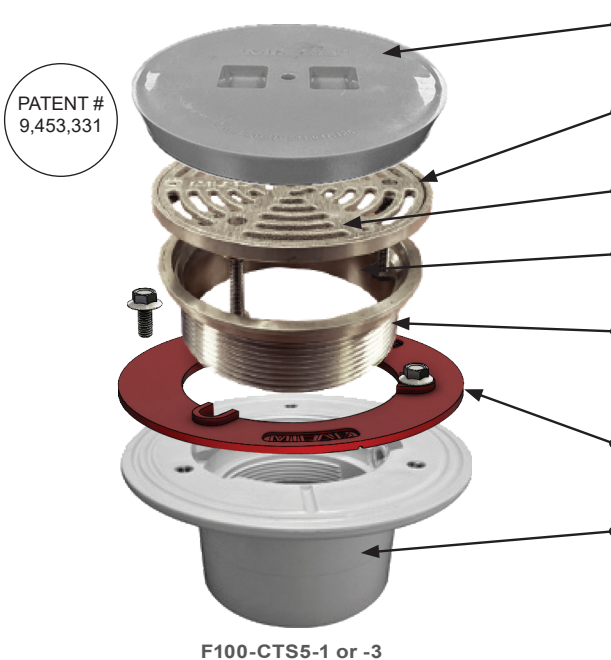
7" and 8" Nickel Bronze (-1) and Stainless Steel (-3) round Top Set strainers are available. Replace TS5 in the model number with TS7 or TS8 and add \$35.00 List to the TS6 List Price for the TS7 add \$95.00 List to the TS6 List Price for the TS8.

**FEATURES AND BENEFITS OF MIFAB'S TOP SET DRAINS**

 PATENT #  
9,453,331

- Plastic cap provided as standard to protect strainer during construction. No need to tape over / clean off strainers.
- No shims needed. Side to side adjustment provided with three integral leveling screws.
- Standard vandal resistant allen key screws
- Up to 1" vertical adjustment after pour to match floor finish. Included within strainer. No need for coring plug and separate finish strainer.
- Strainer and body threads are standard 4" N.P.S.M. for easy use with any 4" N.P.S.M. threaded pipe extension. No proprietary threads like others.
- Membrane clamp optional. Always made from cast iron. No plastic clamps.
- MIFAB's A1 and A4 cast iron and PVC / ABS bodies are shipped standard with a 1/2" trap seal primer tapping and plug.

**F100-CTS5-1 or -3**
**Phillips screwdriver (P2) needed to adjust Top Set screws.**

CALIFORNIA PROPOSITION 65 WARNING. This product contains chemicals known to the State of California to cause cancer and birth defects or other reproductive harm.

**COUNTERLINE C220-TOS TOP SET ROUND DOUBLE ADJUSTABLE FLOOR CLEANOUT WITH COVER**

MODEL #	OUTLET SIZE	COVER DIAMETER & MATERIAL	LIST PRICE
C222-TOS-1 or -3	2" No Hub (Cast Iron)	5" Round, Nickel Bronze (-1) or Stainless Steel (-3)	\$185.50
C223-TOS-1 or -3	3" No Hub (Cast Iron)	5" Round, Nickel Bronze (-1) or Stainless Steel (-3)	\$185.50
C224-TOS-1 or -3	4" No Hub (Cast Iron)	5" Round, Nickel Bronze (-1) or Stainless Steel (-3)	\$185.50
C222P-TOS-1 or -3	2" Push On (Cast Iron)	5" Round, Nickel Bronze (-1) or Stainless Steel (-3)	\$185.50
C223P-TOS-1 or -3	3" Push On (Cast Iron)	5" Round, Nickel Bronze (-1) or Stainless Steel (-3)	\$185.50
C224P-TOS-1 or -3	4" Push On (Cast Iron)	5" Round, Nickel Bronze (-1) or Stainless Steel (-3)	\$185.50
C222-30-TOS-1 or -3	2" PVC Socket	5" Round, Nickel Bronze (-1) or Stainless Steel (-3)	\$117.25
C223-30-TOS-1 or -3	3" PVC Socket	5" Round, Nickel Bronze (-1) or Stainless Steel (-3)	\$117.25
C224-30-TOS-1 or -3	4" PVC Socket	5" Round, Nickel Bronze (-1) or Stainless Steel (-3)	\$117.25
C222-31-TOS-1 or -3	2" ABS Socket	5" Round, Nickel Bronze (-1) or Stainless Steel (-3)	\$117.25
C223-31-TOS-1 or -3	3" ABS Socket	5" Round, Nickel Bronze (-1) or Stainless Steel (-3)	\$117.25
C224-31-TOS-1 or -3	4" ABS Socket	5" Round, Nickel Bronze (-1) or Stainless Steel (-3)	\$117.25

Double adjustable cleanout with no anchor flange for slab on grade installations and round cleanout top assembly with plastic secondary closure plug. Plastic cover included.

**C220-TOS-30**
**C220-TOS**

OPTIONAL VARIATIONS		
SUFFIX	DESCRIPTION	LIST PRICE
-6	Vandal Proof (H-1039A - 3 Pieces)	\$8.50
-15	2" Cast Iron Extension Adapter	\$59.25
-34B	Brass closure plug	\$11.50
-RC	Carpet Marker	\$14.00

**COUNTERLINE C220-TOS-WF TOP SET ROUND DOUBLE ADJUSTABLE FLOOR CLEANOUT WITH WOOD DECK FLANGE & COVER**

MODEL #	OUTLET SIZE	COVER DIAMETER & MATERIAL	LIST PRICE
C222-TOS-WF-1 or -3	2" No Hub (Cast Iron)	5" Round, Nickel Bronze (-1) or Stainless Steel (-3)	\$188.00
C223-TOS-WF-1 or -3	3" No Hub (Cast Iron)	5" Round, Nickel Bronze (-1) or Stainless Steel (-3)	\$188.00
C224-TOS-WF-1 or -3	4" No Hub (Cast Iron)	5" Round, Nickel Bronze (-1) or Stainless Steel (-3)	\$188.00
C222P-TOS-WF-1 or -3	2" Push On (Cast Iron)	5" Round, Nickel Bronze (-1) or Stainless Steel (-3)	\$188.00
C223P-TOS-WF-1 or -3	3" Push On (Cast Iron)	5" Round, Nickel Bronze (-1) or Stainless Steel (-3)	\$188.00
C224P-TOS-WF-1 or -3	4" Push On (Cast Iron)	5" Round, Nickel Bronze (-1) or Stainless Steel (-3)	\$188.00
C222-30-TOS-WF-1 or -3	2" PVC Socket	5" Round, Nickel Bronze (-1) or Stainless Steel (-3)	\$122.50
C223-30-TOS-WF-1 or -3	3" PVC Socket	5" Round, Nickel Bronze (-1) or Stainless Steel (-3)	\$122.50
C224-30-TOS-WF-1 or -3	4" PVC Socket	5" Round, Nickel Bronze (-1) or Stainless Steel (-3)	\$122.50
C222-31-TOS-WF-1 or -3	2" ABS Socket	5" Round, Nickel Bronze (-1) or Stainless Steel (-3)	\$122.50
C223-31-TOS-WF-1 or -3	3" ABS Socket	5" Round, Nickel Bronze (-1) or Stainless Steel (-3)	\$122.50
C224-31-TOS-WF-1 or -3	4" ABS Socket	5" Round, Nickel Bronze (-1) or Stainless Steel (-3)	\$122.50

Double adjustable cleanout with wood deck flange for wood deck installations and round cleanout top assembly with plastic secondary closure plug. Plastic cover included.

**C220-TOS-30-WF**
**C220-TOS-WF**

OPTIONAL VARIATIONS		
SUFFIX	DESCRIPTION	LIST PRICE
-6	Vandal Proof (H-1039A - 3 Pieces)	\$8.50
-15	2" Cast Iron Extension Adapter	\$59.25
-34B	Brass closure plug	\$11.50
-C	Membrane Clamp	\$18.00
-RC	Carpet Marker	\$14.00

CALIFORNIA PROPOSITION 65 WARNING. This product contains chemicals known to the State of California to cause cancer and birth defects or other reproductive harm.

Design and dimensions are subject to modification. Prices do not include applicable taxes.

Visit [www.mifab.com](http://www.mifab.com) for the most recent product information.

MIFAB®, Inc., 1321 West 119th Street, Chicago, Illinois 60643-5109, USA  
All sales subject to MIFAB's® Terms and Warranties. Please refer to page 3.

Toll Free: 1-800-465-2736, Fax: 1-773-341-3049  
sales@mifab.com Canada Toll Free: 1-800-387-3880

### COUNTERLINE F220 ROUND ADJUSTABLE FLOOR DRAIN

F220-30-5-1

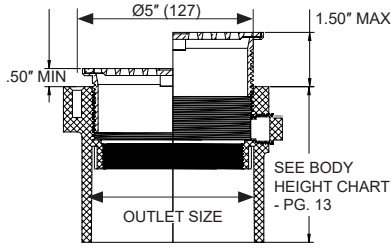

F220P-5-1

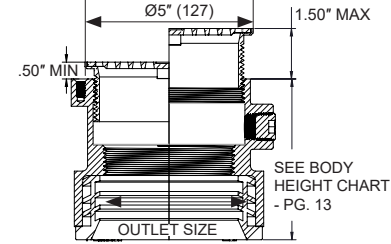

Adjustable Floor Drain with no anchor flange for slab on grade installations and Round Strainer. 1/2" Trap Seal Primer tapping included with all bodies.

*"Our customers prefer MIFAB Counterline Products. Great price point and quality."*

- Neil Werner, Desert Industrial Supply, Pasadena, CA

MODEL #	OUTLET SIZE	STRAINER DIAMETER & MATERIAL	LIST PRICE
F222P-5-1	2" Push On (Cast Iron)	5" Round, Nickel Bronze	\$124.25
F223P-5-1	3" Push On (Cast Iron)	5" Round, Nickel Bronze	\$124.25
F224P-5-1	4" Push On (Cast Iron)	5" Round, Nickel Bronze	\$124.25
F222P-6-1	2" Push On (Cast Iron)	6" Round, Nickel Bronze	\$153.00
F223P-6-1	3" Push On (Cast Iron)	6" Round, Nickel Bronze	\$153.00
F224P-6-1	4" Push On (Cast Iron)	6" Round, Nickel Bronze	\$153.00
F222P-5-4	2" Push On (Cast Iron)	5" Round, Ductile Iron	\$111.50
F223P-5-4	3" Push On (Cast Iron)	5" Round, Ductile Iron	\$111.50
F224P-5-4	4" Push On (Cast Iron)	5" Round, Ductile Iron	\$111.50

OPTIONAL VARIATIONS		
SUFFIX	DESCRIPTION	LIST PRICE
-5	Sediment Bucket (A1-PB)	\$37.25
-6	Vandal Proof (H-1039A - 3 pieces)	\$8.50
-15	2" Cast Iron Extension Adapter	\$59.25

MODEL #	OUTLET SIZE	STRAINER DIAMETER & MATERIAL	LIST PRICE
F222-30-5-1	2" PVC socket	5" Round, Nickel Bronze	\$70.50
F223-30-5-1	3" PVC socket	5" Round, Nickel Bronze	\$70.50
F224-30-5-1	4" PVC socket	5" Round, Nickel Bronze	\$70.50
F222-30-6-1	2" PVC socket	6" Round, Nickel Bronze	\$94.00
F223-30-6-1	3" PVC socket	6" Round, Nickel Bronze	\$94.00
F224-30-6-1	4" PVC socket	6" Round, Nickel Bronze	\$94.00
F222-30-5-4	2" PVC socket	5" Round, Ductile Iron	\$64.00
F223-30-5-4	3" PVC socket	5" Round, Ductile Iron	\$64.00
F224-30-5-4	4" PVC socket	5" Round, Ductile Iron	\$64.00
F222-31-5-1	2" ABS socket	5" Round, Nickel Bronze	\$70.50
F223-31-5-1	3" ABS socket	5" Round, Nickel Bronze	\$70.50
F224-31-5-1	4" ABS socket	5" Round, Nickel Bronze	\$70.50
F222-31-6-1	2" ABS socket	6" Round, Nickel Bronze	\$94.00
F223-31-6-1	3" ABS socket	6" Round, Nickel Bronze	\$94.00
F224-31-6-1	4" ABS socket	6" Round, Nickel Bronze	\$94.00
F222-31-5-4	2" ABS socket	5" Round, Ductile Iron	\$64.00
F223-31-5-4	3" ABS socket	5" Round, Ductile Iron	\$64.00
F224-31-5-4	4" ABS socket	5" Round, Ductile Iron	\$64.00
F222-5-1	2" No Hub (Cast Iron)	5" Round, Nickel Bronze	\$118.25
F223-5-1	3" No Hub (Cast Iron)	5" Round, Nickel Bronze	\$118.25
F224-5-1	4" No Hub (Cast Iron)	5" Round, Nickel Bronze	\$118.25
F222-6-1	2" No Hub (Cast Iron)	6" Round, Nickel Bronze	\$146.00
F223-6-1	3" No Hub (Cast Iron)	6" Round, Nickel Bronze	\$146.00
F224-6-1	4" No Hub (Cast Iron)	6" Round, Nickel Bronze	\$146.00
F222-5-4	2" No Hub (Cast Iron)	5" Round, Ductile Iron	\$104.25
F223-5-4	3" No Hub (Cast Iron)	5" Round, Ductile Iron	\$104.25
F224-5-4	4" No Hub (Cast Iron)	5" Round, Ductile Iron	\$104.25

### COUNTERLINE F220-S SQUARE ADJUSTABLE FLOOR DRAIN

Adjustable Floor Drain with no anchor flange for slab on grade installations and Square Strainer. 1/2" Trap Seal Primer tapping included with all bodies.

F220-30-S5-1

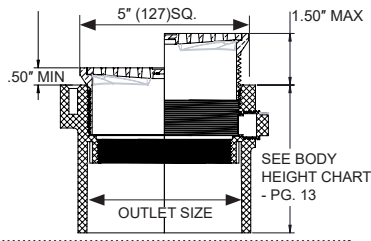

F220P-S5-1

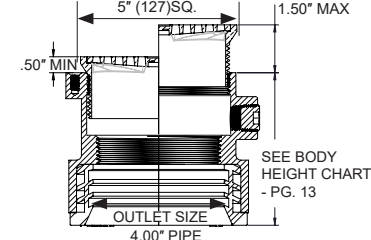

OPTIONAL VARIATIONS		
SUFFIX	DESCRIPTION	LIST PRICE
-5	Sediment Bucket (A1-PB)	\$37.25
-6	Vandal Proof (H-1039A - 3 pieces)	\$8.50
-15	2" Cast Iron Extension Adapter	\$59.25

MODEL #	OUTLET SIZE	STRAINER SIZE & MATERIAL	LIST PRICE
F222-30-S5-1	2" PVC socket	5" Square, Nickel Bronze	\$106.75
F223-30-S5-1	3" PVC socket	5" Square, Nickel Bronze	\$106.75
F224-30-S5-1	4" PVC socket	5" Square, Nickel Bronze	\$106.75
F222-30-S6-1	2" PVC socket	6" Square, Nickel Bronze	\$134.50
F223-30-S6-1	3" PVC socket	6" Square, Nickel Bronze	\$134.50
F224-30-S6-1	4" PVC socket	6" Square, Nickel Bronze	\$134.50
F222-31-S5-1	2" ABS socket	5" Square, Nickel Bronze	\$106.75
F223-31-S5-1	3" ABS socket	5" Square, Nickel Bronze	\$106.75
F224-31-S5-1	4" ABS socket	5" Square, Nickel Bronze	\$106.75
F222-31-S6-1	2" ABS socket	6" Square, Nickel Bronze	\$134.50
F223-31-S6-1	3" ABS socket	6" Square, Nickel Bronze	\$134.50
F224-31-S6-1	4" ABS socket	6" Square, Nickel Bronze	\$134.50
F222-S5-1	2" No Hub (Cast Iron)	5" Square, Nickel Bronze	\$134.50
F223-S5-1	3" No Hub (Cast Iron)	5" Square, Nickel Bronze	\$134.50
F224-S5-1	4" No Hub (Cast Iron)	5" Square, Nickel Bronze	\$134.50
F222-S6-1	2" No Hub (Cast Iron)	6" Square, Nickel Bronze	\$163.50
F223-S6-1	3" No Hub (Cast Iron)	6" Square, Nickel Bronze	\$163.50
F224-S6-1	4" No Hub (Cast Iron)	6" Square, Nickel Bronze	\$163.50
F222P-S5-1	2" Push On (Cast Iron)	5" Square, Nickel Bronze	\$140.25
F223P-S5-1	3" Push On (Cast Iron)	5" Square, Nickel Bronze	\$140.25
F224P-S5-1	4" Push On (Cast Iron)	5" Square, Nickel Bronze	\$140.25
F222P-S6-1	2" Push On (Cast Iron)	6" Square, Nickel Bronze	\$172.75
F223P-S6-1	3" Push On (Cast Iron)	6" Square, Nickel Bronze	\$172.75
F224P-S6-1	4" Push On (Cast Iron)	6" Square, Nickel Bronze	\$172.75

CALIFORNIA PROPOSITION 65 WARNING. This product contains chemicals known to the State of California to cause cancer and birth defects or other reproductive harm.



### COUNTERLINE F100 ROUND ADJUSTABLE FLOOR DRAIN w/ FLANGE

Adjustable Floor Drain with anchor flange and Round Strainer.  
 ½" Trap Seal Primer tapping included with all bodies.

MODEL #	OUTLET SIZE	STRAINER DIAMETER & MATERIAL	LIST PRICE
F102-30-5-1	2" PVC socket	5" Round, Nickel Bronze	\$81.25
F103-30-5-1	3" PVC socket	5" Round, Nickel Bronze	\$81.25
F104-30-5-1	4" PVC socket	5" Round, Nickel Bronze	\$81.25
F102-30-6-1	2" PVC socket	6" Round, Nickel Bronze	\$102.00
F103-30-6-1	3" PVC socket	6" Round, Nickel Bronze	\$102.00
F104-30-6-1	4" PVC socket	6" Round, Nickel Bronze	\$102.00
F102-30-5-4	2" PVC socket	5" Round, Ductile Iron	\$88.00
F103-30-5-4	3" PVC socket	5" Round, Ductile Iron	\$88.00
F104-30-5-4	4" PVC socket	5" Round, Ductile Iron	\$88.00
F102-31-5-1	2" ABS socket	5" Round, Nickel Bronze	\$81.25
F103-31-5-1	3" ABS socket	5" Round, Nickel Bronze	\$81.25
F104-31-5-1	4" ABS socket	5" Round, Nickel Bronze	\$81.25
F102-31-6-1	2" ABS socket	6" Round, Nickel Bronze	\$102.00
F103-31-6-1	3" ABS socket	6" Round, Nickel Bronze	\$102.00
F104-31-6-1	4" ABS socket	6" Round, Nickel Bronze	\$102.00
F102-31-5-4	2" ABS socket	5" Round, Ductile Iron	\$88.00
F103-31-5-4	3" ABS socket	5" Round, Ductile Iron	\$88.00
F104-31-5-4	4" ABS socket	5" Round, Ductile Iron	\$88.00
F102-5-1	2" No Hub (Cast Iron)	5" Round, Nickel Bronze	\$111.50
F103-5-1	3" No Hub (Cast Iron)	5" Round, Nickel Bronze	\$111.50
F104-5-1	4" No Hub (Cast Iron)	5" Round, Nickel Bronze	\$111.50
F102-6-1	2" No Hub (Cast Iron)	6" Round, Nickel Bronze	\$138.25
F103-6-1	3" No Hub (Cast Iron)	6" Round, Nickel Bronze	\$138.25
F104-6-1	4" No Hub (Cast Iron)	6" Round, Nickel Bronze	\$138.25
F102-5-4	2" No Hub (Cast Iron)	5" Round, Ductile Iron	\$110.00
F103-5-4	3" No Hub (Cast Iron)	5" Round, Ductile Iron	\$110.00
F104-5-4	4" No Hub (Cast Iron)	5" Round, Ductile Iron	\$110.00

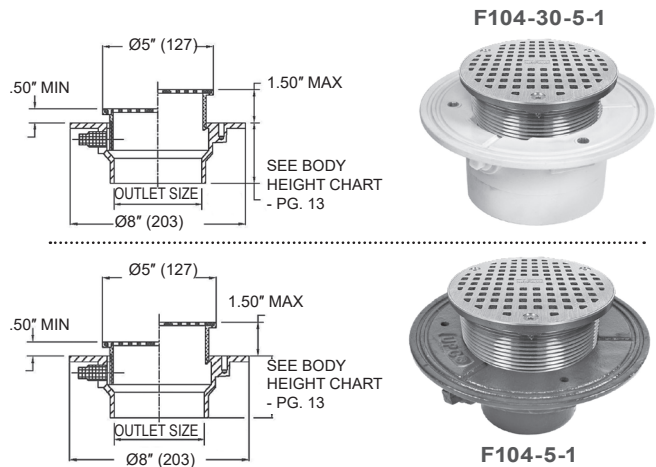

MODEL #	OUTLET SIZE	STRAINER DIAMETER & MATERIAL	LIST PRICE
F102P-5-1	2" Push On (Cast Iron)	5" Round, Nickel Bronze	\$111.50
F103P-5-1	3" Push On (Cast Iron)	5" Round, Nickel Bronze	\$111.50
F104P-5-1	4" Push On (Cast Iron)	5" Round, Nickel Bronze	\$111.50
F102P-6-1	2" Push On (Cast Iron)	6" Round, Nickel Bronze	\$138.25
F103P-6-1	3" Push On (Cast Iron)	6" Round, Nickel Bronze	\$138.25
F104P-6-1	4" Push On (Cast Iron)	6" Round, Nickel Bronze	\$138.25
F102P-5-4	2" Push On (Cast Iron)	5" Round, Ductile Iron	\$116.00
F103P-5-4	3" Push On (Cast Iron)	5" Round, Ductile Iron	\$116.00
F104P-5-4	4" Push On (Cast Iron)	5" Round, Ductile Iron	\$116.00

OPTIONAL VARIATIONS		
SUFFIX	DESCRIPTION	LIST PRICE
-5	Sediment Bucket (A1-PB)	\$37.25
-6	Vandal Proof (H-1039A - 3 pieces)	\$8.50
-15	2" Cast Iron Extension Adapter	\$59.25

### COUNTERLINE F100-S SQUARE ADJUSTABLE FLOOR DRAIN w/ FLANGE

MODEL #	OUTLET SIZE	STRAINER SIZE & MATERIAL	LIST PRICE
F102-30-S5-1	2" PVC socket	5" Square, Nickel Bronze	\$105.50
F103-30-S5-1	3" PVC socket	5" Square, Nickel Bronze	\$105.50
F104-30-S5-1	4" PVC socket	5" Square, Nickel Bronze	\$105.50
F102-30-S6-1	2" PVC socket	6" Square, Nickel Bronze	\$135.50
F103-30-S6-1	3" PVC socket	6" Square, Nickel Bronze	\$135.50
F104-30-S6-1	4" PVC socket	6" Square, Nickel Bronze	\$135.50
F102-31-S5-1	2" ABS socket	5" Square, Nickel Bronze	\$105.50
F103-31-S5-1	3" ABS socket	5" Square, Nickel Bronze	\$105.50
F104-31-S5-1	4" ABS socket	5" Square, Nickel Bronze	\$105.50
F102-31-S6-1	2" ABS socket	6" Square, Nickel Bronze	\$135.50
F103-31-S6-1	3" ABS socket	6" Square, Nickel Bronze	\$135.50
F104-31-S6-1	4" ABS socket	6" Square, Nickel Bronze	\$135.50
F102-S5-1	2" No Hub (Cast Iron)	5" Square, Nickel Bronze	\$125.25
F103-S5-1	3" No Hub (Cast Iron)	5" Square, Nickel Bronze	\$125.25
F104-S5-1	4" No Hub (Cast Iron)	5" Square, Nickel Bronze	\$125.25
F102-S6-1	2" No Hub (Cast Iron)	6" Square, Nickel Bronze	\$154.25
F103-S6-1	3" No Hub (Cast Iron)	6" Square, Nickel Bronze	\$154.25
F104-S6-1	4" No Hub (Cast Iron)	6" Square, Nickel Bronze	\$154.25
F102P-S5-1	2" Push On (Cast Iron)	5" Square, Nickel Bronze	\$131.00
F103P-S5-1	3" Push On (Cast Iron)	5" Square, Nickel Bronze	\$131.00
F104P-S5-1	4" Push On (Cast Iron)	5" Square, Nickel Bronze	\$131.00
F102P-S6-1	2" Push On (Cast Iron)	6" Square, Nickel Bronze	\$162.25
F103P-S6-1	3" Push On (Cast Iron)	6" Square, Nickel Bronze	\$162.25
F104P-S6-1	4" Push On (Cast Iron)	6" Square, Nickel Bronze	\$162.25

Adjustable Floor Drain with anchor flange and Square Strainer.  
 1/2" Trap Seal Primer tapping included with all bodies.

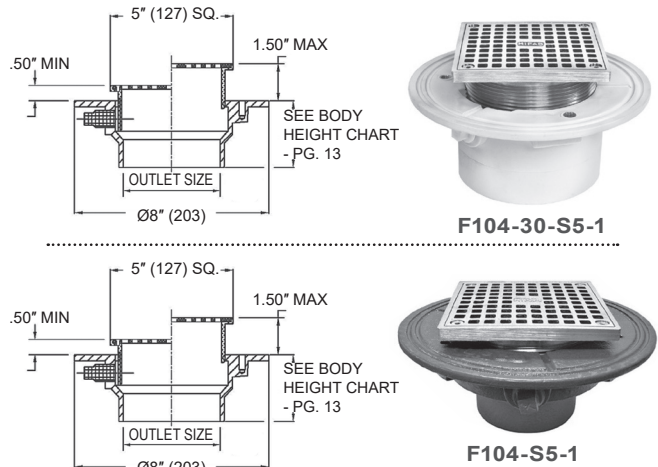

OPTIONAL VARIATIONS		
SUFFIX	DESCRIPTION	LIST PRICE
-5	Sediment Bucket (A1-PB)	\$37.25
-6	Vandal Proof (H-1039A - 4 pieces)	\$8.50
-15	2" Cast Iron Extension Adapter	\$59.25

CALIFORNIA PROPOSITION 65 WARNING. This product contains chemicals known to the State of California to cause cancer and birth defects or other reproductive harm.

Design and dimensions are subject to modification. Prices do not include applicable taxes.

Visit [www.mifab.com](http://www.mifab.com) for the most recent product information.

MIFAB®, Inc., 1321 West 119th Street, Chicago, Illinois 60643-5109, USA

Toll Free: 1-800-465-2736, Fax: 1-773-341-3049

All sales subject to MIFAB's® Terms and Warranties. Please refer to page 3.

sales@mifab.com Canada Toll Free: 1-800-387-3880

### COUNTERLINE F100-C ROUND ADJUSTABLE FLOOR DRAIN with FLANGE & CLAMP



F104-30-C-5-1

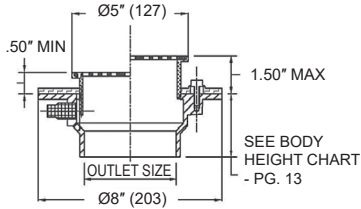

F104-C-5-1

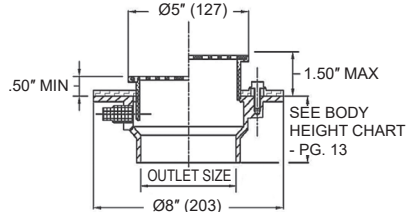

MODEL #	OUTLET SIZE	STRAINER DIAMETER & MATERIAL	LIST PRICE
F102P-C-5-1	2" Push On (Cast Iron)	5" Round, Nickel Bronze	\$121.75
F103P-C-5-1	3" Push On (Cast Iron)	5" Round, Nickel Bronze	\$121.75
F104P-C-5-1	4" Push On (Cast Iron)	5" Round, Nickel Bronze	\$121.75
F102P-C-6-1	2" Push On (Cast Iron)	6" Round, Nickel Bronze	\$149.75
F103P-C-6-1	3" Push On (Cast Iron)	6" Round, Nickel Bronze	\$149.75
F104P-C-6-1	4" Push On (Cast Iron)	6" Round, Nickel Bronze	\$149.75
F102P-C-5-4	2" Push On (Cast Iron)	5" Round, Ductile Iron	\$112.50
F103P-C-5-4	3" Push On (Cast Iron)	5" Round, Ductile Iron	\$112.50
F104P-C-5-4	4" Push On (Cast Iron)	5" Round, Ductile Iron	\$112.50

OPTIONAL VARIATIONS		
SUFFIX	DESCRIPTION	LIST PRICE
-5	Sediment Bucket (A1-PB)	\$37.25
-6	Vandal Proof (H-1039A - 3 pieces)	\$8.50
-15	2" Cast Iron Extension Adapter	\$59.25

Adjustable Floor Drain with anchor flange, membrane clamp and Round Strainer. 1/2" Trap Seal Primer tapping included with all bodies.

MODEL #	OUTLET SIZE	STRAINER DIAMETER & MATERIAL	LIST PRICE
F102-30-C-5-1	2" PVC socket	5" Round, Nickel Bronze	\$93.75
F103-30-C-5-1	3" PVC socket	5" Round, Nickel Bronze	\$93.75
F104-30-C-5-1	4" PVC socket	5" Round, Nickel Bronze	\$93.75
F102-30-C-6-1	2" PVC socket	6" Round, Nickel Bronze	\$113.50
F103-30-C-6-1	3" PVC socket	6" Round, Nickel Bronze	\$113.50
F104-30-C-6-1	4" PVC socket	6" Round, Nickel Bronze	\$113.50
F102-30-C-5-4	2" PVC socket	5" Round, Ductile Iron	\$88.00
F103-30-C-5-4	3" PVC socket	5" Round, Ductile Iron	\$88.00
F104-30-C-5-4	4" PVC socket	5" Round, Ductile Iron	\$88.00
F102-31-C-5-1	2" ABS socket	5" Round, Nickel Bronze	\$93.75
F103-31-C-5-1	3" ABS socket	5" Round, Nickel Bronze	\$93.75
F104-31-C-5-1	4" ABS socket	5" Round, Nickel Bronze	\$93.75
F102-31-C-6-1	2" ABS socket	6" Round, Nickel Bronze	\$113.50
F103-31-C-6-1	3" ABS socket	6" Round, Nickel Bronze	\$113.50
F104-31-C-6-1	4" ABS socket	6" Round, Nickel Bronze	\$113.50
F102-31-C-5-4	2" ABS socket	5" Round, Ductile Iron	\$88.00
F103-31-C-5-4	3" ABS socket	5" Round, Ductile Iron	\$88.00
F104-31-C-5-4	4" ABS socket	5" Round, Ductile Iron	\$88.00
F102-C-5-1	2" No Hub (Cast Iron)	5" Round, Nickel Bronze	\$114.75
F103-C-5-1	3" No Hub (Cast Iron)	5" Round, Nickel Bronze	\$114.75
F104-C-5-1	4" No Hub (Cast Iron)	5" Round, Nickel Bronze	\$114.75
F102-C-6-1	2" No Hub (Cast Iron)	6" Round, Nickel Bronze	\$143.75
F103-C-6-1	3" No Hub (Cast Iron)	6" Round, Nickel Bronze	\$143.75
F104-C-6-1	4" No Hub (Cast Iron)	6" Round, Nickel Bronze	\$143.75
F102-C-5-4	2" No Hub (Cast Iron)	5" Round, Ductile Iron	\$110.00
F103-C-5-4	3" No Hub (Cast Iron)	5" Round, Ductile Iron	\$110.00
F104-C-5-4	4" No Hub (Cast Iron)	5" Round, Ductile Iron	\$110.00

### COUNTERLINE F100-C-S SQUARE ADJUSTABLE FLOOR DRAIN with FLANGE & CLAMP

Adjustable Floor Drain with anchor flange, membrane clamp and Square Strainer. 1/2" Trap Seal Primer tapping included with all bodies.



F104-30-C-S5-1

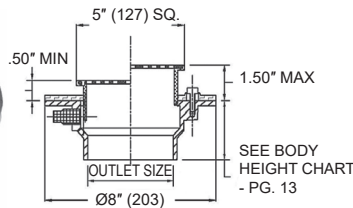

F104-C-S5-1

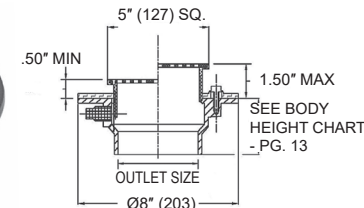

OPTIONAL VARIATIONS		
SUFFIX	DESCRIPTION	LIST PRICE
-5	Sediment Bucket (A1-PB)	\$37.25
-6	Vandal Proof (H-1039A - 3 pieces)	\$8.50
-15	2" Cast Iron Extension Adapter	\$59.25

MODEL #	OUTLET SIZE	STRAINER SIZE & MATERIAL	LIST PRICE
F102-30-C-S5-1	2" PVC socket	5" Square, Nickel Bronze	\$118.25
F103-30-C-S5-1	3" PVC socket	5" Square, Nickel Bronze	\$118.25
F104-30-C-S5-1	4" PVC socket	5" Square, Nickel Bronze	\$118.25
F102-30-C-S6-1	2" PVC socket	6" Square, Nickel Bronze	\$142.75
F103-30-C-S6-1	3" PVC socket	6" Square, Nickel Bronze	\$142.75
F104-30-C-S6-1	4" PVC socket	6" Square, Nickel Bronze	\$142.75
F102-31-C-S5-1	2" ABS socket	5" Square, Nickel Bronze	\$118.25
F103-31-C-S5-1	3" ABS socket	5" Square, Nickel Bronze	\$118.25
F104-31-C-S5-1	4" ABS socket	5" Square, Nickel Bronze	\$118.25
F102-31-C-S6-1	2" ABS socket	6" Square, Nickel Bronze	\$142.75
F103-31-C-S6-1	3" ABS socket	6" Square, Nickel Bronze	\$142.75
F104-31-C-S6-1	4" ABS socket	6" Square, Nickel Bronze	\$142.75
F102-C-S5-1	2" No Hub (Cast Iron)	5" Square, Nickel Bronze	\$139.25
F103-C-S5-1	3" No Hub (Cast Iron)	5" Square, Nickel Bronze	\$139.25
F104-C-S5-1	4" No Hub (Cast Iron)	5" Square, Nickel Bronze	\$139.25
F102-C-S6-1	2" No Hub (Cast Iron)	6" Square, Nickel Bronze	\$168.00
F103-C-S6-1	3" No Hub (Cast Iron)	6" Square, Nickel Bronze	\$168.00
F104-C-S6-1	4" No Hub (Cast Iron)	6" Square, Nickel Bronze	\$168.00
F102P-C-S5-1	2" Push On (Cast Iron)	5" Square, Nickel Bronze	\$145.00
F103P-C-S5-1	3" Push On (Cast Iron)	5" Square, Nickel Bronze	\$145.00
F104P-C-S5-1	4" Push On (Cast Iron)	5" Square, Nickel Bronze	\$145.00
F102P-C-S6-1	2" Push On (Cast Iron)	6" Square, Nickel Bronze	\$174.00
F103P-C-S6-1	3" Push On (Cast Iron)	6" Square, Nickel Bronze	\$174.00
F104P-C-S6-1	4" Push On (Cast Iron)	6" Square, Nickel Bronze	\$174.00

CALIFORNIA PROPOSITION 65 WARNING. This product contains chemicals known to the State of California to cause cancer and birth defects or other reproductive harm.

### COUNTERLINE F300 7" ROUND ADJUSTABLE AREA DRAIN

Adjustable Area Drain with anchor flange and 7" Round Strainer.  
1/2" Trap Seal Primer tapping included with all bodies.

MODEL #	OUTLET SIZE	STRAINER DIAMETER & MATERIAL	LIST PRICE
F302-30-4	2" PVC socket	7" Round, Ductile Iron	\$134.50
F303-30-4	3" PVC socket	7" Round, Ductile Iron	\$134.50
F304-30-4	4" PVC socket	7" Round, Ductile Iron	\$134.50
F302-31-4	2" ABS socket	7" Round, Ductile Iron	\$134.50
F303-31-4	3" ABS socket	7" Round, Ductile Iron	\$134.50
F304-31-4	4" ABS socket	7" Round, Ductile Iron	\$134.50
F302-4	2" No Hub (Cast Iron)	7" Round, Ductile Iron	\$158.75
F303-4	3" No Hub (Cast Iron)	7" Round, Ductile Iron	\$158.75
F304-4	4" No Hub (Cast Iron)	7" Round, Ductile Iron	\$158.75
F302P-4	2" Push On (Cast Iron)	7" Round, Ductile Iron	\$158.75
F303P-4	3" Push On (Cast Iron)	7" Round, Ductile Iron	\$158.75
F304P-4	4" Push On (Cast Iron)	7" Round, Ductile Iron	\$158.75

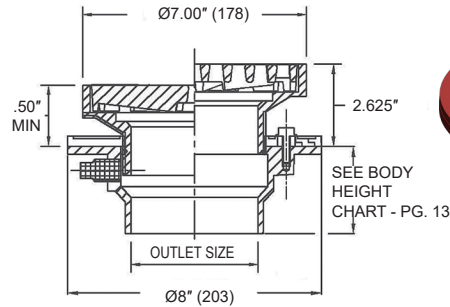

F304-4

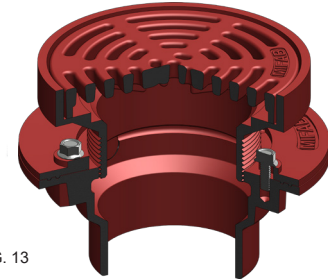

Note: Illustrated with -C optional membrane clamp

"I always supply my customers with MIFAB area drains because they come standard with ductile iron grates (not cast iron). They offer the best quality up front!" — Dave Becker, VP Plumbing Products, Chesapeake Systems, Baltimore, MD

### COUNTERLINE F320 9" ROUND ADJUSTABLE AREA DRAIN

Adjustable Area Drain with anchor flange and 9" Round Strainer.  
1/2" Trap Seal Primer tapping included with all bodies.

MODEL #	OUTLET SIZE	STRAINER DIAMETER & MATERIAL	LIST PRICE
F322-30-4	2" PVC socket	9" Round, Ductile Iron	\$165.75
F323-30-4	3" PVC socket	9" Round, Ductile Iron	\$165.75
F324-30-4	4" PVC socket	9" Round, Ductile Iron	\$165.75
F322-31-4	2" ABS socket	9" Round, Ductile Iron	\$165.75
F323-31-4	3" ABS socket	9" Round, Ductile Iron	\$165.75
F324-31-4	4" ABS socket	9" Round, Ductile Iron	\$165.75
F322-4	2" No Hub (Cast Iron)	9" Round, Ductile Iron	\$178.50
F323-4	3" No Hub (Cast Iron)	9" Round, Ductile Iron	\$178.50
F324-4	4" No Hub (Cast Iron)	9" Round, Ductile Iron	\$178.50
F322P-4	2" Push On (Cast Iron)	9" Round, Ductile Iron	\$178.50
F323P-4	3" Push On (Cast Iron)	9" Round, Ductile Iron	\$178.50
F324P-4	4" Push On (Cast Iron)	9" Round, Ductile Iron	\$178.50

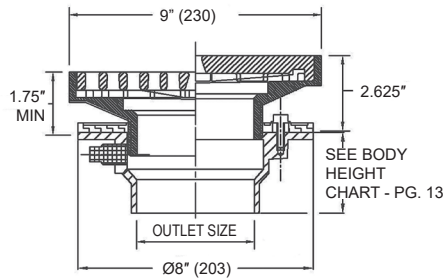

F324-4

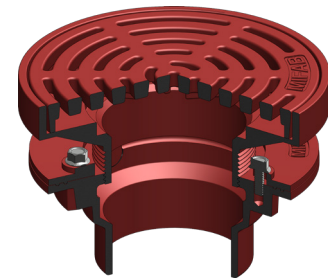

Note: Illustrated with -C optional membrane clamp

### COUNTERLINE F330 9" ROUND PVC AREA DRAIN

PVC body and top area drain with anchor flange, membrane clamp, 1/2" trap seal primer tapping and removable grate with medium duty load rating. All PVC body and top assembly ideal for applications that have corrosive elements in the wastewater.

MODEL #	OUTLET SIZE	LIST PRICE
F332-30	2" Schedule 40 PVC Socket	\$84.00
F333-30	3" Schedule 40 PVC Socket	\$84.00
F334-30	4" Schedule 40 PVC Socket	\$84.00

OPTIONAL VARIATIONS FOR THE F300, F320 AND F330		
SUFFIX	DESCRIPTION	LIST PRICE
-5	Sediment Bucket	\$37.25
-6	Vandal resistant screws (H-1072 - 1 piece)	\$19.00
-69	Stainless Steel Sediment Bucket	\$94.50
-C	Membrane Clamp (included with F330)	\$19.00
-F4-1	4" Round Nickel Bronze Funnel	\$131.25
-F4-50	4" Round Cast Iron Funnel	\$105.00
-G-1	4" x 9" Oval Nickel Bronze Funnel	\$183.75
-G-50	4" x 9" Oval Cast Iron Funnel	\$157.50

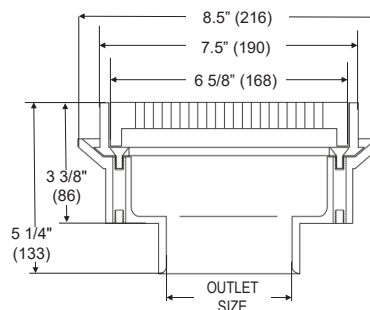

F330



Note: 4" outlet socket connection body fits into 4" PVC pipe and over 3" PVC pipe.

CALIFORNIA PROPOSITION 65 WARNING. This product contains chemicals known to the State of California to cause cancer and birth defects or other reproductive harm.

Design and dimensions are subject to modification. Prices do not include applicable taxes.

Visit [www.mifab.com](http://www.mifab.com) for the most recent product information.

MIFAB®, Inc., 1321 West 119th Street, Chicago, Illinois 60643-5109, USA

Toll Free: 1-800-465-2736, Fax: 1-773-341-3049

All sales subject to MIFAB's® Terms and Warranties. Please refer to page 3.

sales@mifab.com Canada Toll Free: 1-800-387-3880

### COUNTERLINE C220-R

### 5" ROUND ADJUSTABLE FLOOR CLEANOUT



**C224-30-R-4**

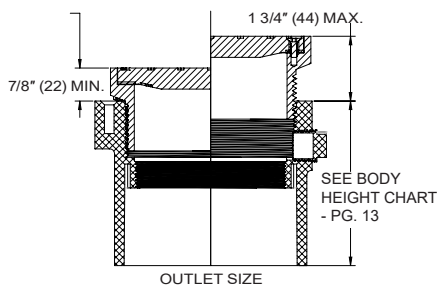

**C224P-R-1**

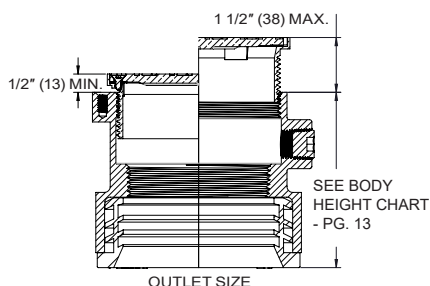

OPTIONAL VARIATIONS		
SUFFIX	DESCRIPTION	LIST PRICE
-6	Vandal Proof (H-1039A - 3 pieces)	\$19.00
-15	2" Cast Iron Extension Adapter	\$59.25

Adjustable Floor Cleanout with Round Top Assembly.

MODEL #	OUTLET SIZE	TOP ASSEMBLY DIAMETER & MATERIAL	LIST PRICE
C222-30-R-1	2" PVC socket	5" Round, Nickel Bronze	\$99.50
C223-30-R-1	3" PVC socket	5" Round, Nickel Bronze	\$99.50
C224-30-R-1	4" PVC socket	5" Round, Nickel Bronze	\$99.50
C222-30-R-4	2" PVC socket	5" Round, Ductile Iron	\$75.50
C223-30-R-4	3" PVC socket	5" Round, Ductile Iron	\$75.50
C224-30-R-4	4" PVC socket	5" Round, Ductile Iron	\$75.50
C222-31-R-1	2" ABS socket	5" Round, Nickel Bronze	\$99.50
C223-31-R-1	3" ABS socket	5" Round, Nickel Bronze	\$99.50
C224-31-R-1	4" ABS socket	5" Round, Nickel Bronze	\$99.50
C222-31-R-4	2" ABS socket	5" Round, Ductile Iron	\$75.50
C223-31-R-4	3" ABS socket	5" Round, Ductile Iron	\$75.50
C224-31-R-4	4" ABS socket	5" Round, Ductile Iron	\$75.50
C222-R-1	2" No Hub (Cast Iron)	5" Round, Nickel Bronze	\$127.50
C223-R-1	3" No Hub (Cast Iron)	5" Round, Nickel Bronze	\$127.50
C224-R-1	4" No Hub (Cast Iron)	5" Round, Nickel Bronze	\$127.50
C222-R-4	2" No Hub (Cast Iron)	5" Round, Ductile Iron	\$113.75
C223-R-4	3" No Hub (Cast Iron)	5" Round, Ductile Iron	\$113.75
C224-R-4	4" No Hub (Cast Iron)	5" Round, Ductile Iron	\$113.75
C222P-R-1	2" Push On (Cast Iron)	5" Round, Nickel Bronze	\$121.25
C223P-R-1	3" Push On (Cast Iron)	5" Round, Nickel Bronze	\$121.25
C224P-R-1	4" Push On (Cast Iron)	5" Round, Nickel Bronze	\$121.25
C222P-R-4	2" Push On (Cast Iron)	5" Round, Ductile Iron	\$120.50
C223P-R-4	3" Push On (Cast Iron)	5" Round, Ductile Iron	\$120.50
C224P-R-4	4" Push On (Cast Iron)	5" Round, Ductile Iron	\$120.50

### COUNTERLINE C220-S

### 5" SQUARE ADJUSTABLE FLOOR CLEANOUT



**C224-30-S-1**

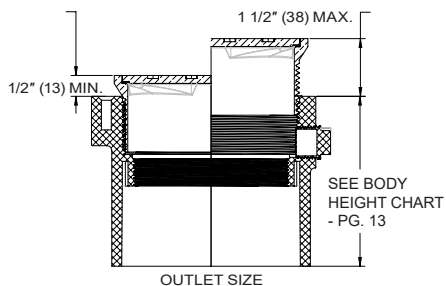

**C224P-S-1**

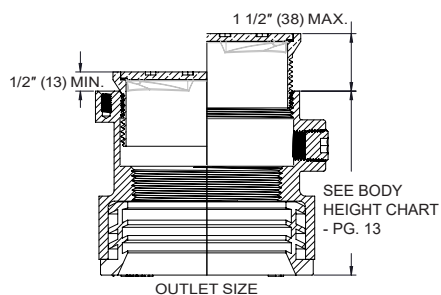

OPTIONAL VARIATIONS		
SUFFIX	DESCRIPTION	LIST PRICE
-6	Vandal Proof (H-1039A - 3 pieces)	\$19.00
-15	2" Cast Iron Extension Adapter	\$59.25

Adjustable Floor Cleanout with Square Top Assembly.

MODEL #	OUTLET SIZE	TOP ASSEMBLY SIZE & MATERIAL	LIST PRICE
C222-30-S-1	2" PVC socket	5" Square, Nickel Bronze	\$110.00
C223-30-S-1	3" PVC socket	5" Square, Nickel Bronze	\$110.00
C224-30-S-1	4" PVC socket	5" Square, Nickel Bronze	\$110.00
C222-31-S-1	2" ABS socket	5" Square, Nickel Bronze	\$110.00
C223-31-S-1	3" ABS socket	5" Square, Nickel Bronze	\$110.00
C224-31-S-1	4" ABS socket	5" Square, Nickel Bronze	\$110.00
C222-S-1	2" No Hub (Cast Iron)	5" Square, Nickel Bronze	\$137.00
C223-S-1	3" No Hub (Cast Iron)	5" Square, Nickel Bronze	\$137.00
C224-S-1	4" No Hub (Cast Iron)	5" Square, Nickel Bronze	\$137.00
C222P-S-1	2" Push On (Cast Iron)	5" Square, Nickel Bronze	\$143.75
C223P-S-1	3" Push On (Cast Iron)	5" Square, Nickel Bronze	\$143.75
C224P-S-1	4" Push On (Cast Iron)	5" Square, Nickel Bronze	\$143.75

CALIFORNIA PROPOSITION 65 WARNING. This product contains chemicals known to the State of California to cause cancer and birth defects or other reproductive harm.

### DRAIN BODIES

(A1 BODY WITH FLANGE, A4 BODY WITHOUT FLANGE)

#### A4 BODY - CAST IRON PUSH ON WITH GASKET

1/2" Trap seal primer tapping and plug included for no extra cost.

MODEL #	DESCRIPTION	LIST PRICE
A4-2P-7-CL	2" Push On Outlet Size	\$52.25
A4-3P-7-CL	3" Push On Outlet Size	\$52.25
A4-4P-7-CL	4" Push On Outlet Size	\$52.25



#### A4 BODY - CAST IRON NO HUB

1/2" Trap seal primer tapping and plug included for no extra cost.

MODEL #	DESCRIPTION	LIST PRICE
A4-2NH-7-CL	2" No Hub Outlet Size	\$52.25
A4-3NH-7-CL	3" No Hub Outlet Size	\$52.25
A4-4NH-7-CL	4" No Hub Outlet Size	\$52.25



#### A4 BODY - PVC SOLVENT WELD

1/2" Trap seal primer tapping and plug included for no extra cost.

MODEL #	DESCRIPTION	LIST PRICE
A4-2-30-7-CL	2" PVC Solvent Weld Outlet Size	\$32.75
A4-3-30-7-CL	3" PVC Solvent Weld Outlet Size	\$32.75
A4-4-30-7-CL	4" PVC Solvent Weld Outlet Size	\$32.75



#### A4 BODY - ABS SOLVENT WELD

1/2" Trap seal primer tapping and plug included for no extra cost.

MODEL #	DESCRIPTION	LIST PRICE
A4-2-31-7-CL	2" ABS Solvent Weld Outlet Size	\$32.75
A4-3-31-7-CL	3" ABS Solvent Weld Outlet Size	\$32.75
A4-4-31-7-CL	4" ABS Solvent Weld Outlet Size	\$32.75



#### A1 BODY - CAST IRON PUSH ON WITH GASKET

1/2" Trap seal primer tapping and plug included for no extra cost.

MODEL #	DESCRIPTION	LIST PRICE
A1-2P-7-CL	2" Push On Outlet Size	\$58.00
A1-3P-7-CL	3" Push On Outlet Size	\$58.00
A1-4P-7-CL	4" Push On Outlet Size	\$58.00



#### A1 BODY - CAST IRON NO HUB

1/2" Trap seal primer tapping and plug included for no extra cost.

MODEL #	DESCRIPTION	LIST PRICE
A1-2NH-7-CL	2" No Hub Outlet Size	\$58.00
A1-3NH-7-CL	3" No Hub Outlet Size	\$58.00
A1-4NH-7-CL	4" No Hub Outlet Size	\$58.00



#### A1 BODY - PVC SOLVENT WELD

1/2" Trap seal primer tapping and plug included for no extra cost.

MODEL #	DESCRIPTION	LIST PRICE
A1-2-30-7-CL	2" PVC Solvent Weld Outlet Size	\$41.75
A1-3-30-7-CL	3" PVC Solvent Weld Outlet Size	\$41.75
A1-4-30-7-CL	4" PVC Solvent Weld Outlet Size	\$41.75



#### A1 BODY - ABS SOLVENT WELD

1/2" Trap seal primer tapping and plug included for no extra cost.

MODEL #	DESCRIPTION	LIST PRICE
A1-2-31-7-CL	2" ABS Solvent Weld Outlet Size	\$41.75
A1-3-31-7-CL	3" ABS Solvent Weld Outlet Size	\$41.75
A1-4-31-7-CL	4" ABS Solvent Weld Outlet Size	\$41.75



### DRAIN AND CLEANOUT TOPS



**SQUARE**

S5-1-CL



5-1-CL

MODEL #	DESCRIPTION	LIST PRICE
S5-1-CL	5" Square Nickel Bronze Strainer	\$89.25
S6-1-CL	6" Square Nickel Bronze Strainer	\$124.00

MODEL #	DESCRIPTION	LIST PRICE
5-1-CL	5" Round Nickel Bronze Strainer	\$61.50
6-1-CL	6" Round Nickel Bronze Strainer	\$95.25
F300-TA-4-CL	7" Round Ductile Iron Strainer	\$101.00
F320-TA-4-CL	9" Round Ductile Iron Strainer	\$126.50
X5-4-CL	5" Round Heavy Duty Ductile Iron Strainer, 10,000 lb. Special Duty Load rated.	\$31.50

#### A1 BODY - HEIGHT CHART

OUTLET SIZE	PVC (-30), ABS (-31)	NO HUB (STANDARD)	PUSH ON (P)
2"	2 5/8"	3"	3 3/8"
3"	3 1/4"	3"	3 3/8"
4"	3 1/2"	3"	3 3/8"

#### A4 BODY - HEIGHT CHART

OUTLET SIZE	PVC (-30), ABS (-31)	NO HUB (STANDARD)	PUSH ON (P)
2"	3 5/8"	4"	4 3/8"
3"	4 5/16"	4"	4 3/8"
4"	4 11/16"	4"	4 3/8"

### TOP SET STRAINERS

MODEL #	DESCRIPTION	LIST PRICE
TS5-1 or -3-CL	5" Round NB (-1) or SS (-3) Strainer	\$61.50
TS6-1 or -3-CL	6" Round NB (-1) or SS (-3) Strainer	\$95.25



TS5-1-CL

### TOP SET CLEANOUT TOPS

MODEL #	DESCRIPTION	LIST PRICE
TOS-1-CL or -3-CL	5" Round NB (-1) or SS (-3) cleanout top	\$66.25

TOS-1-CL



### CLEANOUT TOPS

**SQUARE**

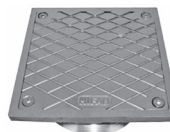

S-1-CL

**ROUND**



XR-4-CL

MODEL #	DESCRIPTION	LIST PRICE
S-1-CL	5" Square Nickel Bronze Cleanout Top Assembly	\$77.75

MODEL #	DESCRIPTION	LIST PRICE
R-1-CL	5" Round Nickel Bronze Cleanout Top Assembly	\$66.25
XR-4-CL	5" Round Heavy Duty Ductile Iron Cleanout Top Assembly, 10,000 lb. Special Duty Load rated.	\$50.00

CALIFORNIA PROPOSITION 65 WARNING. This product contains chemicals known to the State of California to cause cancer and birth defects or other reproductive harm.

Design and dimensions are subject to modification. Prices do not include applicable taxes.

Visit [www.mifab.com](http://www.mifab.com) for the most recent product information.

MIFAB®, Inc., 1321 West 119th Street, Chicago, Illinois 60643-5109, USA

Toll Free: 1-800-465-2736, Fax: 1-773-341-3049

All sales subject to MIFAB's® Terms and Warranties. Please refer to page 3.

sales@mifab.com Canada Toll Free: 1-800-387-3880

### SD7000

### SHOWER DRAIN WITH STAMPED STAINLESS STEEL GRATE

Shower drain with ABS, or lacquered cast iron body, membrane clamp, adjustable strainer with stamped stainless steel grate. Recommended for molded shower stalls where the drain body is installed onto the pipe before the shower unit is installed.



SD7001 illustrated



SD7102-S4 illustrated

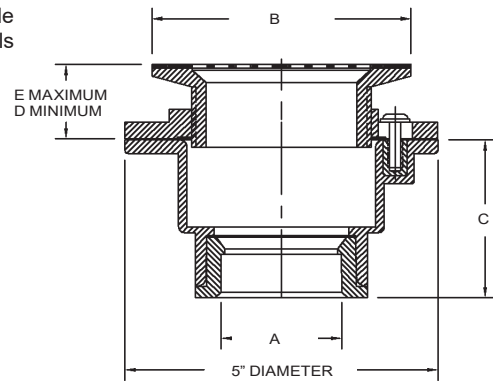

*"We use the MIFAB SD7000 Series shower drains on all of our condo buildings. Installation is easy and the stainless top looks great?"*

– Primo Mechanical, Toronto, Canada

SD7001, SD7002	4" Diameter stamped stainless steel strainer with ABS body and membrane clamp	<b>\$22.25 List Price</b>
SD7101, SD7102	4" Diameter stamped stainless steel strainer with cast iron body and ABS membrane clamp	<b>\$44.25 List Price</b>
-S4	4" x 4" top strainer assembly only with stainless steel stamped grate (add <b>\$8.50</b> for the 4" x 4" top assembly to the above List Prices)	

MODEL #	PRODUCT DESCRIPTION	A IN	B IN	C IN	D IN	E IN	WEIGHT LBS.
SD7001	1 1/2" (38) ABS body w/S.S. Grate	1 7/8" (48)	4" (102) Dia.	2 1/2" (64)	3/4" (19)	1 1/2" (38)	.75
SD7002	2" (50) ABS body w/S.S. Grate	2 3/8" (60)	4" (102) Dia.	2 1/2" (64)	3/4" (19)	1 1/2" (38)	.75
SD7101	1 1/2" (38) Cast Iron body w/S.S. Grate	1 1/2" (38) IPS	4" x 4" (102)	2 1/2" (64)	3/4" (19)	1 1/2" (38)	1.75
SD7102	2" (50) Cast Iron body w/S.S. Grate	2" (51) IPS	4" x 4" (102)	2 1/2" (64)	3/4" (19)	1 1/2" (38)	1.75

OPTIONAL VARIATIONS		
MODEL #	DESCRIPTION	LIST PRICE
-6	Vandal Resistant	<b>\$9.50</b>

### FD212TC-49

### SHOWER DRAIN WITH CAST IRON BODY AND CHROME PLATED CAST BRASS STRAINER

Shower drain with lacquered cast iron body, membrane clamp, and chrome plated cast brass strainer.



FD212TC-49 illustrated



FD212TC-S5-49 illustrated

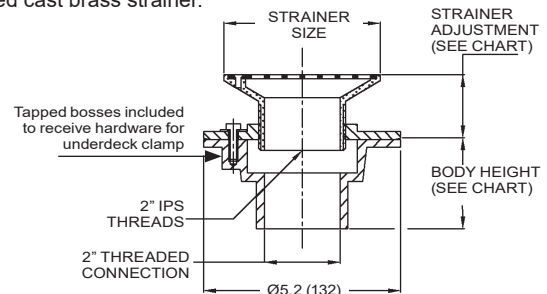

MODEL #	PRODUCT DESCRIPTION	LIST PRICE
FD212TC-49	4" Diameter chrome plated cast brass strainer with 2" Threaded cast iron body and membrane clamp	<b>\$70.75</b>
FD212C-49	4" Diameter chrome plated cast brass strainer with 2" No Hub cast iron body and membrane clamp	<b>\$70.75</b>
FD212C-S5-49	4" x 4" chrome plated cast brass strainer with 2" No Hub cast iron body and membrane clamp	<b>\$86.00</b>
FD212TC-S5-49	4" x 4" chrome plated cast brass strainer with 2" Threaded cast iron body and membrane clamp	<b>\$86.00</b>

MODEL #	STRAINER SIZE	STRAINER ADJUSTMENT			ANSI / ASME RATING		BODY HEIGHT	WEIGHT LBS.
		PIPE SIZE	MIN.	MAX.	FREE AREA	LOAD RATING		
FD212TC-49	4 1/8" (105) DIA.	2" (52) IPS	1 3/8" (35)	2 1/4" (63)	5.0 in <sup>2</sup>	Up to 2,000 lbs.	2 5/16" (59)	4
FD212C-49	4 1/8" (105) DIA.	2" (52) No Hub	1 3/8" (35)	2 1/4" (63)	5.0 in <sup>2</sup>	Up to 2,000 lbs.	2 1/2" (63)	4
FD212C-S5-49	5" (125) x 5" (125)	2" (52) No Hub	1 3/8" (35)	2 1/4" (63)	9.0 in <sup>2</sup>	Up to 2,000 lbs.	2 1/2" (63)	5
FD212TC-S5-49	5" (125) x 5" (125)	2" (52) IPS	1 3/8" (35)	2 1/4" (63)	9.0 in <sup>2</sup>	Up to 2,000 lbs.	2 5/16" (59)	5

CALIFORNIA PROPOSITION 65 WARNING. This product contains chemicals known to the State of California to cause cancer and birth defects or other reproductive harm.

### FD230 LIGHT DUTY FLOOR DRAIN

Light duty floor drain with PVC, ABS or lacquered cast iron body, and 5" diameter ductile iron or nickel bronze grate.



All models with ductile iron grate (-4)	\$28.00
All models with nickel bronze grate (-1)	\$49.00

MODEL #	STRAINER DIAMETER	OUTLET SIZE	ANSI / ASME RATING			BODY HEIGHT				WEIGHT LBS.
			FREE AREA	LOAD RATING N.B. (-1)	LOAD RATING D.I. (-4)	CAST IRON BODY (-50)	NICKEL BRONZE BODY (-1)	PVC BODY (-30)	ABS BODY (-31)	
FD232	5" (125)	2" (52)	8 in <sup>2</sup> (5200 <sup>2</sup> )	Up to 2,000 lbs.	Up to 7,499 lbs.	2 3/16" (56)	2 3/16" (56)	2 5/8" (67)	2 5/8" (67)	4
FD233	5" (125)	3" (76)	8 in <sup>2</sup> (5200 <sup>2</sup> )	Up to 2,000 lbs.	Up to 7,499 lbs.	2 3/16" (56)	2 3/16" (56)	2 5/8" (67)	2 5/8" (67)	4
FD234	5" (125)	4" (102)	8 in <sup>2</sup> (5200 <sup>2</sup> )	Up to 2,000 lbs.	Up to 7,499 lbs.	2 3/16" (56)	2 3/16" (56)	2 5/8" (67)	2 5/8" (67)	4

SUFFIX	OPTIONAL VARIATIONS
-1	Nickel Bronze Grate
-4	Ductile Iron Grate
-30	PVC Socket Connection Body
-31	ABS Socket Connection Body
-50	No Hub Cast Iron Body

### FD240 HEAVY DUTY FLOOR DRAIN

Heavy duty lacquered cast iron floor drain with 6 1/2" diameter, 1/2" thick ductile iron grate with 10 square inches of free area.

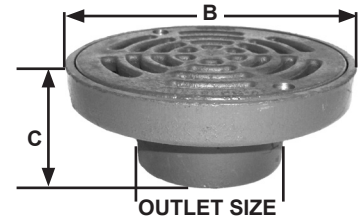

All models	\$104.25
------------	----------

MODEL #	PRODUCT DESCRIPTION	OUTLET SIZE (NO HUB)	B IN	C IN	ANSI / ASME LOAD RATING	WEIGHT LBS.
FD242-4	2" (50) No hub cast iron body	2" (52)	6 1/2" (165)	3" (75)	Heavy Duty	4
FD243-4	3" (75) No hub cast iron body	3" (76)	6 1/2" (165)	3" (75)	Heavy Duty	4
FD244-4	4" (100) No hub cast iron body	4" (102)	6 1/2" (165)	3" (75)	Heavy Duty	4

### FD230-WF WOOD DECK FLOOR DRAIN

Floor drain with 8" diameter securing flange for wood floors, PVC, ABS, or lacquered cast iron body, and 5" diameter grate.



All Models with ductile iron grate (-4)	\$93.75
All Models with nickel bronze grate (-1)	\$121.75

MODEL #	STRAINER DIAMETER	OUTLET SIZE (NO HUB)	ANSI / ASME RATING			BODY HEIGHT			WEIGHT LBS.
			FREE AREA	LOAD RATING N.B. (-1)	LOAD RATING D.I. (-4)	CAST IRON BODY (-50)	PVC BODY (-30)	ABS BODY (-31)	
FD232-WF	5" (125)	2" (52)	8 in <sup>2</sup> (5200 <sup>2</sup> )	Up to 2,000 lbs.	Up to 7,499 lbs.	2 3/16" (56)	2 5/8" (67)	2 5/8" (67)	4
FD233-WF	5" (125)	3" (76)	8 in <sup>2</sup> (5200 <sup>2</sup> )	Up to 2,000 lbs.	Up to 7,499 lbs.	2 3/16" (56)	2 5/8" (67)	2 5/8" (67)	4
FD234-WF	5" (125)	4" (102)	8 in <sup>2</sup> (5200 <sup>2</sup> )	Up to 2,000 lbs.	Up to 7,499 lbs.	2 3/16" (56)	2 5/8" (67)	2 5/8" (67)	4

SUFFIX	OPTIONAL VARIATIONS
-1	Nickel Bronze Grate
-4	Ductile Iron Grate
-30	PVC Socket Connection Body
-31	ABS Socket Connection Body
-50	No Hub Cast Iron Body

CALIFORNIA PROPOSITION 65 WARNING. This product contains chemicals known to the State of California to cause cancer and birth defects or other reproductive harm.

Design and dimensions are subject to modification. Prices do not include applicable taxes.

Visit [www.mifab.com](http://www.mifab.com) for the most recent product information.

MIFAB®, Inc., 1321 West 119th Street, Chicago, Illinois 60643-5109, USA  
All sales subject to MIFAB's® Terms and Warranties. Please refer to page 3.

Toll Free: 1-800-465-2736, Fax: 1-773-341-3049  
sales@mifab.com Canada Toll Free: 1-800-387-3880

### FLOOR DRAIN OPTIONS



SUFFIX	DESCRIPTION	LIST PRICE
-5	Sediment bucket (A1-MB-CL)	\$37.25
-15	Adjustable extension (DD-50-CL)	\$59.25
-F4-50	4" Cast iron funnel (F4-50-CL)	\$67.25
-F6-50	6" Cast iron funnel (F6-50-CL)	\$97.50
-G-50	9" Oval funnel (G-50-CL)	\$108.00

### SHOWER SUB DRAINS

#### 50-SD

#### SHOWER SUB DRAIN



Shower sub drain with cast iron body and non adjustable stainless steel strainer.

MODEL #	OUTLET SIZE	OUTLET TYPE	WEIGHT LBS.	STRAINER SIZE	LIST PRICE
50-SD-T	2"	Threaded	6	3 1/2"	\$58.00
50-SD-TC	2"	Push-On w/test cap	6	3 1/2"	\$58.00
50-SD-31	2"	ABS Socket	3	3 1/2"	\$51.00

#### FD-960

#### SNAP IN GRATE



MODEL #	DESCRIPTION	LIST PRICE
FD-962	2" Snap In Stainless Steel Grate	\$11.75
FD-963	3" Snap In Stainless Steel Grate	\$12.75
FD-964	4" Snap In Stainless Steel Grate	\$18.75

#### F650

#### ROUND WOOD DECK DRAIN

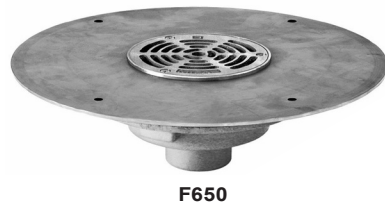

Cast iron 14" diameter flanged deck drain with 6 1/2" diameter nickel bronze grate.

MODEL #	OUTLET SIZE	OUTLET TYPE	WEIGHT LBS.	LIST PRICE
F652	2"	No Hub	10	\$258.50
F653	3"	No Hub	10	\$318.50
F654	4"	No Hub	10	\$362.50
F652T	2"	Threaded	10	\$285.00
F653T	3"	Threaded	10	\$333.75

### SIDEWALK BOXES

#### SW

#### CAST IRON SIDEWALK BOXES with DUCTILE IRON COVERS

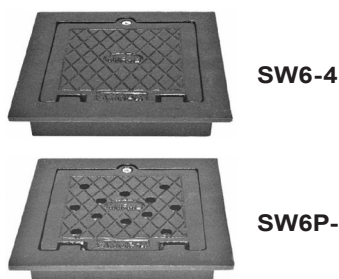

MODEL #	SIZE	DESCRIPTION	WEIGHT LBS.	LIST PRICE
SW6-4	6 3/4" x 6 3/4"	Ductile iron solid cover w/ cast iron frame	4	\$59.25
SW6P-4	6 3/4" x 6 3/4"	Ductile iron perforated cover w/ cast iron frame	4	\$70.75
SW6-PC-4	5" x 5"	Replacement ductile iron solid cover only	2	\$37.50
SW6P-PC-4	5" x 5"	Replacement ductile iron perforated cover only	2	\$43.00

OPTIONAL VARIATIONS		
SIZE	DESCRIPTION	LIST PRICE
-6	Vandal Proof Cover (#H-1039A-10-24 x 3/8" flat head torx and pin stainless steel machine screw)	\$25.75

*"Our Customers Love Counterline! From Shower Drains to Roof Drains, it's the best price point and highest quality in the industry! Our MIFAB Rep is top notch too! Great product, Great Price, Fantastic Rep! What else can we ask for?"*

– Joe Rooks, L.A. Plumbing Supply, Duarte, CA

CALIFORNIA PROPOSITION 65 WARNING. This product contains chemicals known to the State of California to cause cancer and birth defects or other reproductive harm.



### R100 CAST IRON ROOF DRAIN

MODEL #	OUTLET SIZE	OUTLET TYPE	LIST PRICE, STANDARD PLASTIC DOME	LIST PRICE ALUMINUM DOME (-M)
R102, 3, 4	2", 3", 4"	No Hub	\$96.50	\$121.75
R106	6"	No Hub	\$111.50	\$137.00
R102, 3, 4P	2", 3", 4"	Push-On	\$119.50	\$145.00
R102, 3, 4T	2", 3", 4"	Threaded	\$192.25	\$218.00
R102,3,4-30 or 31	2", 3", 4"	PVC / ABS Socket	\$96.50	\$122.00

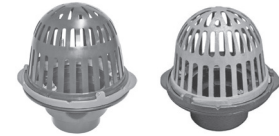

R100 R100-M

SUFFIX	DESCRIPTION	LIST PRICE
-U	Under Deck Clamp (A1-C3-CL)	\$33.75
A1-PD-CL	Replacement poly dome only	\$27.00
A1-MD-CL	Replacement metal dome only	\$41.75

NOTE: 2" PVC / ABS body fits over 2" pipe or into 3" pipe. 3" PVC / ABS body fits over 3" pipe or into 4" pipe.

### R100-90 CAST IRON ROOF DRAIN with ALUMINUM DOME and SIDE OUTLET

MODEL #	OUTLET SIZE	OUTLET TYPE	LIST PRICE STANDARD ALUMINUM DOME
R102,3,4NH-90	2", 3", 4"	No Hub	\$218.00
R102, 3, 4T-90	2", 3", 4"	Threaded	\$218.00



R100-90

### R100-OFF CAST IRON ROOF DRAIN with ALUMINUM DOME and OVERFLOW STANDPIPE

MODEL #	OUTLET SIZE	OUTLET TYPE	LIST PRICE STANDARD ALUMINUM DOME
R102,3,4NH-OFF	2", 3", 4"	No Hub	\$151.75
R102, 3, 4P-OFF	2", 3", 4"	Push On	\$160.00



R100-OFF

### R150 CAST IRON COMBINED ROOF DRAIN with ALUMINUM DOMES and OVERFLOW STANDPIPE

MODEL #	OUTLET SIZE	OUTLET TYPE	LIST PRICE (1 per carton) STANDARD ALUMINUM DOMES
R152, 3, 4	2", 3", 4"	No Hub	\$233.25
R152,3,4-M-2.75	2", 3", 4"	No Hub	\$275.00 (with 2 3/4" high low profile domes for under slab applications.)

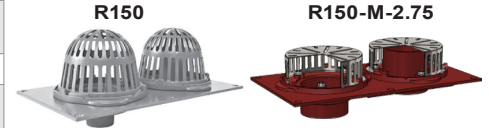

R150

R150-M-2.75

### R200 LARGE SUMP CAST IRON ROOF DRAIN

MODEL #	OUTLET SIZE	OUTLET TYPE	LIST PRICE, STANDARD PLASTIC DOME	LIST PRICE, CAST IRON DOME (-M)	LIST PRICE, ALUMINUM DOME (-M-80)	SUFFIX	DESCRIPTION	LIST PRICE
R202,3,4	2", 3", 4"	No Hub	\$288.75	\$367.50	\$367.50	-B	Sump Receiver (A2-BP-CL)	\$131.25
R206	6"	No Hub	\$404.25	\$483.00	\$483.00	-E	Adjustable extension	\$315.00
R208	8"	No Hub	\$525.00	\$603.75	\$603.75	-G	Stainless Steel Ballast Guard (A2-BG-CL)	\$315.00
						-R	2" high water dam (A2-WD-CL)	\$105.00
						-U	Under Deck Clamp (A2-C3-CL)	\$115.50
						-V	2" high fixed extension	\$288.75
						-90	Side Outlet (3" or 4")	\$157.50



### C230-TS CLEANOUT COVER with THUMBSCREWS FOR 2"- 4" PIPE SIZE

MODEL #	FITS OUTLET SIZE	WEIGHT LBS.	CARTON QUANTITY	LIST PRICE NICKEL BRONZE (-1)	LIST PRICE DUCTILE IRON (-4)
C234-TS	2", 3"	3	36	\$86.00	\$81.25
C236-TS	4"	6	18	\$110.00	\$103.25
C234-PC	Cover only	1	-	\$70.75	\$39.50
C236-PC	Cover only	1	-	\$95.50	\$62.75

C234-TS-1



### C300 FLOOR ACCESS COVERS

MODEL #	SIZE AND DESCRIPTION	WEIGHT LBS.	LIST PRICE NICKEL BRONZE (-1)	LIST PRICE DUCTILE IRON (-4)
C300-R6	6" round with lugs	8	\$95.50	\$61.50
C300-R6-NL	6" round with no lugs	8	\$95.50	\$61.50
C300-S7	7" square with lugs	9	\$130.00	\$76.50



C300-R6-1

C300-R6-NL

C300-S7-1

CALIFORNIA PROPOSITION 65 WARNING. This product contains chemicals known to the State of California to cause cancer and birth defects or other reproductive harm.

Design and dimensions are subject to modification. Prices do not include applicable taxes.

Visit [www.mifab.com](http://www.mifab.com) for the most recent product information.

MIFAB®, Inc., 1321 West 119th Street, Chicago, Illinois 60643-5109, USA

Toll Free: 1-800-465-2736, Fax: 1-773-341-3049

All sales subject to MIFAB's® Terms and Warranties. Please refer to page 3.

sales@mifab.com Canada Toll Free: 1-800-387-3880

### CF

### CAST IRON CLOSET FLANGE WITH GASKET CONNECTION

MODEL #	DESCRIPTION	CARTON QUANTITY	LIST PRICE
CF32TC	4" Dia. top mounting flange x 3" pipe connection x 2" high with integral rubber test cap	12	\$39.50
CF42	4" Dia. top mounting flange x 4" pipe connection x 2" high - no test cap	8	\$37.50
CF42TC	4" Dia. top mounting flange x 4" pipe connection x 2" high with integral rubber test cap	8	\$39.50
CFOS42TC	4" Dia. top mounting offset flange x 4" pipe connection x 2" high with integral rubber test cap	12	\$77.75
CF44DTC	4" Dia. top mounting flange x 4" pipe connection x 4" high with integral rubber test cap	8	\$52.25
CF46DTC	4" Dia. top mounting flange x 4" pipe connection x 6" high with integral rubber test cap	8	\$67.25



CF42TC



CFOS42TC



CF44DTC

**NOTE:** CFOS42TC has 4 slots on the top so that the offset can be in two different positions.

### RFD

### REPLACEMENT ROOF DRAIN

Manufactured from 16 gauge steel with an acid resistant powder epoxy coating on bearing pan and funnel body. Furnished with poly dome strainer, dome receiver with integral gravel guard and gasket seal.

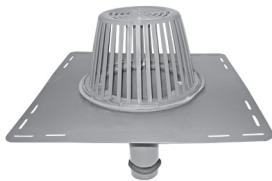

MODEL #	PIPE SIZE	LIST PRICE
RFD-3	3" [76] Push in	\$400.00
RFD-4	4" [76] Push in	\$416.00
RFD-5	5" [76] Push in	\$503.75
RFD-6	6" [76] Push in	\$503.75

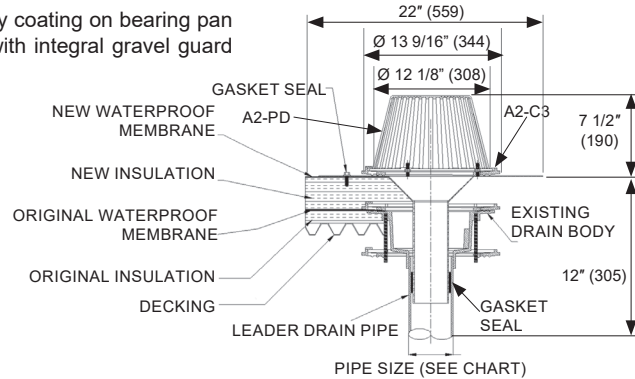

#### OPTIONAL VARIATIONS

SUFFIX	DESCRIPTION	LIST PRICE
-6	Vandal proof dome (metal dome only)	\$34.75
-M-80	Low aluminum dome	\$89.25
-M	Cast iron dome	\$89.25

### MI-CONN

### CAST IRON CONNECTION FITTING FOR DECKS AND BETWEEN SLABS

Fixture mounting and connection fitting. The MI-CONN secures drains to the slab / deck during rough-in. Provides easy access to integral connections when wood deck forms are removed or add to it for thicker slabs. Ideal for insulated and non insulated pipes. Cast iron construction allows for use as a firestop sleeve.

**MI-CONN products will be available March, 2025**

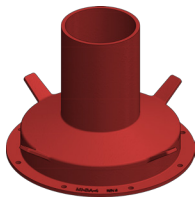

MODEL #	PIPE SIZE	D	d	H	h1	h2	LIST PRICE
MI-CONN-2	2" NH	10 1/2"	8 1/2"	8"	6 3/4"	6 1/4"	\$50.00
MI-CONN-3	3" NH	10 1/2"	8 1/2"	8"	6 3/4"	5 7/8"	\$53.00
MI-CONN-4	4" NH	10 1/2"	8 1/2"	8"	6 5/8"	5 1/2"	\$56.00
MI-CONN-6	6" NH	12 1/2"	10 1/2"	8"	6 5/8"	6"	\$60.00

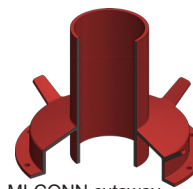

MI-CONN cutaway

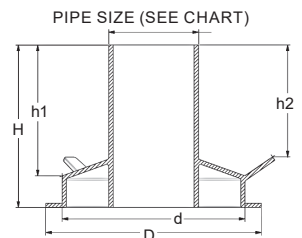

### MI-SCOV

### CAST IRON SEWER BOX SEWER LID AND COVER



MI-SCOV - side view



MI-SCOV-W-8 - top view

MODEL #	OVERALL DIAMETER	COVER DIAMETER	HEIGHT
MI-SCOV-8	11"	9"	2.50"
MI-SCOV-10	13"	11"	2.50"

SUFFIX	OPTIONAL VARIATIONS	LIST PRICE
-11	Acid resistant epoxy coated lid and collar	\$116.00
-13	Galvanized lid and collar	\$116.00

MODEL #	DESCRIPTION	LIST PRICE
MI-SCOV-W-8	8" water lid and collar	\$64.00
MI-SCOV-S-8	8" sewer lid and collar	\$64.00
MI-SCOV-8	8" plain lid and collar	\$64.00
MI-SCOV-W-10	10" water lid and collar	\$64.00
MI-SCOV-S-10	10" sewer lid and collar	\$75.50
MI-SCOV-10	10" plain lid and collar	\$75.50

CALIFORNIA PROPOSITION 65 WARNING. This product contains chemicals known to the State of California to cause cancer and birth defects or other reproductive harm.

### DIELECTRIC NIPPLES

#### THREADED BY THREADED

MODEL #	DESCRIPTION	CARTON QUANTITY	LIST PRICE
MI-DETT-50	1/2" x 3" long, threaded by threaded	25	\$21.00
MI-DETT-75	3/4" x 3" long, threaded by threaded	25	\$21.00
MI-DETT-100	1" x 4" long, threaded by threaded	25	\$31.50
MI-DETT-125	1 1/4" x 4" long, threaded by threaded	10	\$46.25
MI-DETT-150	1 1/2" x 4" long threaded by threaded	10	\$51.00
MI-DETT-200	2" x 4" long, threaded by threaded	10	\$63.00
MI-DETT-250	2 1/2" x 6" long, threaded by threaded	6	\$87.00
MI-DETT-300	3" x 6" long, threaded by threaded	6	\$102.25
MI-DETT-350	3 1/2" x 6" long, threaded by threaded	6	\$119.50
MI-DETT-400	4" x 6" long, threaded by threaded	6	\$137.00

#### GROOVED BY THREADED

MODEL #	DESCRIPTION	CARTON QUANTITY	LIST PRICE
MI-DEGT-50	1/2" x 3" long, grooved by threaded	25	\$21.00
MI-DEGT-75	3/4" x 3" long, grooved by threaded	25	\$21.00
MI-DEGT-100	1" x 4" long, grooved by threaded	25	\$31.50
MI-DEGT-125	1 1/4" x 4" long, grooved by threaded	10	\$46.25
MI-DEGT-150	1 1/2" x 4" long grooved by threaded	10	\$51.00
MI-DEGT-200	2" x 4" long, grooved by threaded	10	\$63.00
MI-DEGT-250	2 1/2" x 6" long, grooved by threaded	6	\$87.00
MI-DEGT-300	3" x 6" long, grooved by threaded	6	\$87.00
MI-DEGT-350	3 1/2" x 6" long, grooved by threaded	6	\$119.50
MI-DEGT-400	4" x 6" long, grooved by threaded	6	\$137.00

#### GROOVED BY GROOVED

MODEL #	DESCRIPTION	CARTON QUANTITY	LIST PRICE
MI-DEGG-200	2" x 4" long, grooved by grooved	10	\$31.50
MI-DEGG-250	2 1/2" x 6" long, grooved by grooved	6	\$67.25
MI-DEGG-300	3" x 6" long, grooved by grooved	6	\$83.50
MI-DEGG-400	4" x 6" long, grooved by grooved	6	\$99.75

"I enjoy selling MIFAB's FS520 PVC floor sinks - they are packaged professionally and make it easy to sell with other product lines. Not to mention priced very competitively." - Jerry Slutsky, RW Sales, Dallas, TX



MI-DETT Series



MI-DEGT Series



MI-DEGG Series

#### R1800 MEMBRANE CLAMP LOCKDOWN CLAMPS

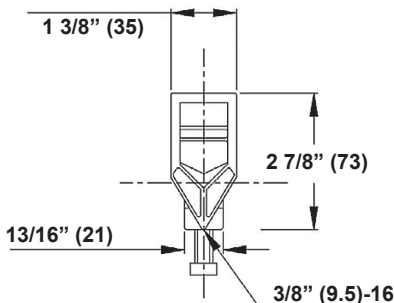

CAST METAL

MODEL #	DESCRIPTION	BAG QUANTITY	LIST PRICE
R1800	Lockdown Clamps w/ hardware	4	\$31.50

#### C1440-TP ECONOMY TEST PLUGS

**Specification:** MIFAB C1440-TP Series of economy test plugs with galvanized steel flange, neoprene rubber gasket, and galvanized steel wing nut operating screw. Temperature rating of 0° - 125° F.

**Function:** Fits into cast iron and / or plastic pipe to seal the pipe opening. Operates within a 2 p.s.i. back pressure. Ideal for pressure tests of sewer pipes through test connection with hollow screw. The test plug offers a simple and quick installation by inserting it into the pipe end (spigot end or socket).

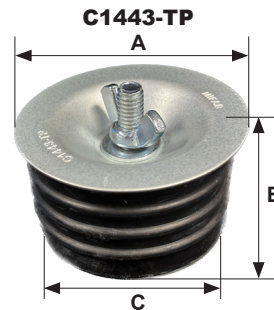

MODEL NUMBER	PIPE SIZE	A	B	C	WEIGHT (OUNCES)	LIST PRICE
C1441.5-TP	1 1/2"	2 1/4"	1 1/8"	1 1/2"	5.00	\$4.75
C1442-TP	2"	2 1/4"	1 1/8"	1 3/4"	7.00	\$5.00
C1443-TP	3"	3 1/4"	1 5/8"	2 3/4"	8.50	\$6.00
C1444-TP	4"	4 1/4"	1 5/8"	3 3/4"	12.50	\$8.00
C1446-TP	6"	6 1/4"	1 5/8"	5 3/4"	18.00	\$10.50

CALIFORNIA PROPOSITION 65 WARNING. This product contains chemicals known to the State of California to cause cancer and birth defects or other reproductive harm.

Design and dimensions are subject to modification. Prices do not include applicable taxes.

Visit [www.mifab.com](http://www.mifab.com) for the most recent product information.

MIFAB®, Inc., 1321 West 119th Street, Chicago, Illinois 60643-5109, USA

Toll Free: 1-800-465-2736, Fax: 1-773-341-3049

All sales subject to MIFAB's® Terms and Warranties. Please refer to page 3.

sales@mifab.com Canada Toll Free: 1-800-387-3880

### PVC FLOOR SINKS

PVC floor sinks are manufactured out of PVC material to provide the ultimate in sanitary design. PVC material has excellent resistance to chemicals such as the acids contained in fruits, vegetables and fats. The smooth, uniform surface is easy to clean and the floor sink will not chip or rust. PVC floor sinks are lightweight for easier handling, installation and transportation. MIFAB offers PVC floor sinks in either 8" or 12" square flangeless bodies with bottom dome strainer and with full, three-quarter or half PVC, nickel bronze or stainless steel grate configurations.

#### FS520-30

#### 8" SQUARE x 6" DEEP PVC FLOOR SINK



Two removable quarter sections to have full, 1/2 or 3/4 grate all in one.



PATENT #  
9,458,616

Bottom dome strainer included with every floor sink body (Starting April, 2025)

8" square x 6" deep PVC floor sink body, less flange, with loose set full PVC grate and bottom dome strainer.

MODEL #	OUTLET SIZE	LIST PRICE
FS522-30	2" PVC socket	\$130.00
FS523-30	3" PVC socket	\$130.00
FS524-30	4" PVC socket	\$130.00

Note: 4" outlet socket connection body fits into 4" PVC pipe and over 3" PVC pipe.

FS520-PG-30 grate only  
**\$38.50**

*"The MIFAB PVC floor sink 3 in 1 grate is a huge benefit to my customers. Being able to configure the grate from a full grate to a 3/4 grate or 1/2 grate is a reduction of inventory skews, and the wholesaler always has the grate that is needed for projects."*

— Steve Calhoun, Principal, Blackjack Mountain Marketing, Inc., Little Rock, AR

#### FS720-30

#### 12" SQUARE x 6" DEEP PVC FLOOR SINK

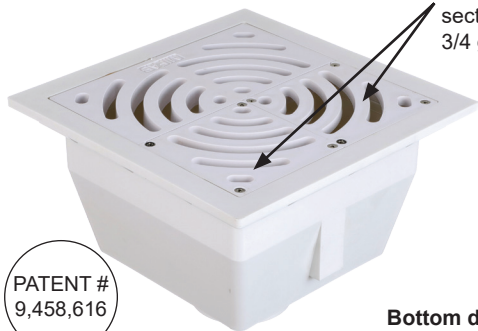

Two removable quarter sections to have full, 1/2 or 3/4 grate all in one.



PATENT #  
9,458,616

Bottom dome strainer included with every floor sink body (Starting April, 2025)

12" Square x 6" deep PVC floor sink body, less flange, with loose set full PVC grate and bottom dome strainer.

MODEL #	OUTLET SIZE	LIST PRICE
FS722-30	2" PVC socket	\$150.75
FS723-30	3" PVC socket	\$150.75
FS724-30	4" PVC socket	\$150.75

Note: 4" outlet socket connection body fits into 4" PVC pipe and over 3" PVC pipe.

FS720-PG-30 grate only  
**\$42.00**

#### OPTIONAL VARIATIONS FOR FS520-30 and FS720-30

SUFFIX	DESCRIPTION	FS520-30 List Price Adder	FS720-30 List Price Adder
-1-150	1/2 Nickel Bronze grate and frame	\$189.00	\$218.00
-1-175	3/4 Nickel Bronze grate and frame	\$189.00	\$218.00
-3-150	1/2 Stainless Steel grate and frame	\$189.00	\$218.00
-3-175	3/4 Stainless Steel grate and frame	\$189.00	\$218.00
-1	Full Nickel Bronze grate and frame	\$189.00	\$218.00
-3	Full Stainless Steel grate and frame	\$189.00	\$218.00
-5	Sediment bucket (FS520-SB for 8" x 8" and FS720-SB for 12" x 12")	\$49.00	\$49.00
-69	Stainless Steel Sediment Bucket (FS520-SB-3 for 8" x 8" and FS720-SB-3 for 12" x 12")	\$121.75	\$134.50
-150	1/2 PVC grate	No Add	No Add
-175	3/4 PVC grate	No Add	No Add
(Standard)	Full PVC grate	No Add	No Add

CALIFORNIA PROPOSITION 65 WARNING. This product contains chemicals known to the State of California to cause cancer and birth defects or other reproductive harm.

### FS520

### 8" SQUARE x 6" DEEP FLOOR SINK

8" Square x 6" deep cast iron floor sink with white acid resistant enamel coated interior, loose set acid resistant enamel cast iron grate, and aluminum dome bottom strainer.

MODEL #	LIST PRICE	CONNECTION SIZE			CONNECTION TYPE			WEIGHT LBS.
		2"	3"	4"	No Hub	Push On	Inside Caulk	
FS520	\$223.75	Yes	Yes	Yes	(Standard)	-P	-X	18
Body Only	\$166.00	Yes	Yes	Yes	(Standard)	-P	-X	15
Grate Only	\$57.75				(Standard)	-P	-X*	3



\* indicates that the floor sink body is a transition body with A3-PG gasket and A1 body included.

### FS720

### 12" SQUARE x 6" DEEP FLOOR SINK

12" Square x 6" deep cast iron floor sink with white acid resistant enamel coated interior, loose set acid resistant enamel cast iron grate, and aluminum dome bottom strainer.

MODEL #	LIST PRICE	CONNECTION SIZE			CONNECTION TYPE			WEIGHT LBS.
		2"	3"	4"	No Hub	Push On	Inside Caulk	
FS720	\$265.25	Yes	Yes	Yes	(Standard)	-P	-X	29
Body Only	\$190.25	Yes	Yes	Yes	(Standard)	-P	-X	25
Grate Only	\$75.25				(Standard)	-P	-X	4



### FS730

### 12" SQUARE x 8" DEEP FLOOR SINK

12" Square x 8" deep cast iron floor sink with white acid resistant enamel coated interior, loose set acid resistant enamel cast iron grate, and aluminum dome bottom strainer.

MODEL #	LIST PRICE	CONNECTION SIZE			CONNECTION TYPE			WEIGHT LBS.
		2"	3"	4"	No Hub	Push On	Inside Caulk	
FS730	\$284.00	Yes	Yes	Yes	(Standard)	-P	-X	37
Body Only	\$208.50	Yes	Yes	Yes	(Standard)	-P	-X	33
Grate Only	\$75.50				(Standard)	-P	-X	4



### FS740

### 12" SQUARE x 10" DEEP FLOOR SINK

12" Square x 10" deep cast iron floor sink with white acid resistant enamel coated interior, loose set acid resistant enamel cast iron grate, and aluminum dome bottom strainer.

MODEL #	LIST PRICE	CONNECTION SIZE			CONNECTION TYPE			WEIGHT LBS.
		2"	3"	4"	No Hub	Push On	Inside Caulk	
FS740	\$373.25	Yes	Yes	Yes	(Standard)	-P	-X*	42
Body Only	\$297.75	Yes	Yes	Yes	(Standard)	-P	-X*	36
Grate Only	\$75.50				(Standard)	-P	-X*	6



\* indicates that the floor sink body is a transition body with A3-PG gasket and A1 body included

#### OPTIONAL VARIATIONS

SUFFIX	DESCRIPTION	FS520	FS720	FS730	FS740
-5	Sediment Bucket	\$62.75	\$80.25	\$80.25	\$80.25
-150	1/2 Grate	No Add	No Add	No Add	No Add
-175	3/4 Grate	No Add	No Add	No Add	No Add
-SPL	Split Grate	Not Available	\$73.25	\$73.25	\$73.25



CALIFORNIA PROPOSITION 65 WARNING. This product contains chemicals known to the State of California to cause cancer and birth defects or other reproductive harm.

Design and dimensions are subject to modification. Prices do not include applicable taxes.

Visit [www.mifab.com](http://www.mifab.com) for the most recent product information.

MIFAB®, Inc., 1321 West 119th Street, Chicago, Illinois 60643-5109, USA

Toll Free: 1-800-465-2736, Fax: 1-773-341-3049

All sales subject to MIFAB's® Terms and Warranties. Please refer to page 3.

sales@mifab.com Canada Toll Free: 1-800-387-3880

**MCL-G SERIES GREASE INTERCEPTORS**

Regularly manufactured with an electrostatically applied baked powder epoxy coating and supplied with an external, vented, flow control fitting. 14 gauge material used for body.

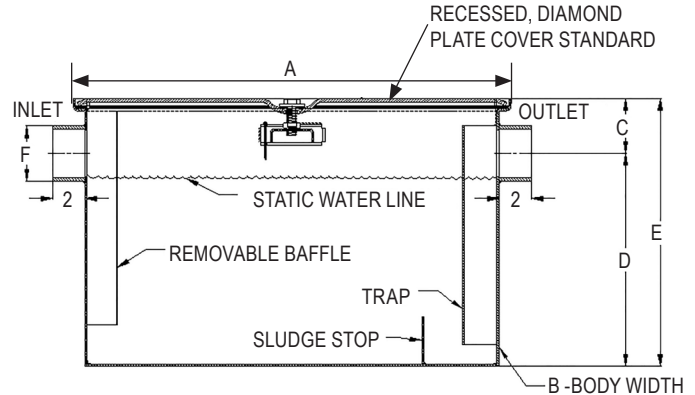

OPTIONAL VARIATIONS		
SUFFIX	DESCRIPTION	List Price
-T	2" Threaded Outlet (Add)	<b>\$43.75</b>
-T	3" Threaded Outlet (Add)	<b>\$56.75</b>
-T	4" Threaded Outlet (Add)	<b>\$86.00</b>

**Modifications are not available to dimensions of product.**

Choose MIFAB's MI-G Grease Interceptor Series when integral extensions, anchor flanges and other optional variations are required.

See the MPB List Price Book.



MODEL #	U.S. GPM	CAP LBS.	A	B	C	D	E	F	# LIDS	# OF BOLTS	LIST PRICE	WEIGHT LBS.
MCL-G-0	4	8 lbs.	16 3/4"	11 1/4"	2 1/2"	8 1/2"	11"	2"	1	1	<b>\$501.00</b>	45
MCL-G-1	7	14 lbs.	17 3/4"	13 3/4"	3 1/2"	8 1/2"	12"	2"	1	1	<b>\$661.00</b>	54
MCL-G-2	10	20 lbs.	21 1/4"	15 3/4"	3 1/2"	9 1/2"	13"	2"	1	1	<b>\$753.00</b>	72
MCL-G-3	15	30 lbs.	23 3/4"	15 3/4"	3 1/2"	11 1/2"	15"	2"	1	1	<b>\$893.00</b>	85
MCL-G-4	20	40 lbs.	23 3/4"	15 3/4"	3 1/2"	14"	17 1/2"	3"	1	1	<b>\$1003.00</b>	90
MCL-G-5	25	50 lbs.	27 3/4"	18 3/4"	3 1/2"	14"	17 1/2"	3"	1	1	<b>\$1,358.00</b>	112
MCL-G-6	35	70 lbs.	31 1/4"	23 3/4"	5 1/2"	16 1/2"	22"	3"	1	4	<b>\$1,629.00</b>	166
MCL-G-7	50	100 lbs.	31 1/4"	23 3/4"	5 1/2"	18 1/2"	24"	3"	1	4	<b>\$1,863.00</b>	175
XL-MCL-G-0	75	150 lbs.	42"	28"	6"	26"	32"	4"	2	8	<b>\$3,881.00</b>	250
XL-MCL-G-1	100	200 lbs.	55"	37"	8"	26"	34"	4"	2	8	<b>\$4,763.00</b>	400

*"I win the largest projects by quoting MIFAB for all of my steel interceptors including custom steel interceptors. The fabrication team at MIFAB offers the best capabilities in the industry!"*

– Dan Thomas, President, Ben Thomas & Associates, Shape Gap, PA

CALIFORNIA PROPOSITION 65 WARNING. This product contains chemicals known to the State of California to cause cancer and birth defects or other reproductive harm.

**MCL-G-L SERIES LOW PROFILE GREASE INTERCEPTORS**

Regularly manufactured with an electrostatically applied baked powder epoxy coating and supplied with an external, vented, flow control fitting.

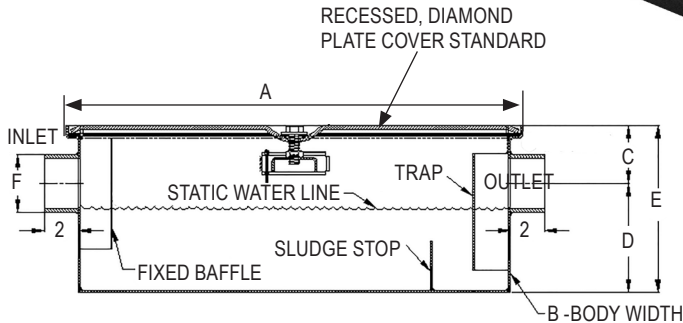
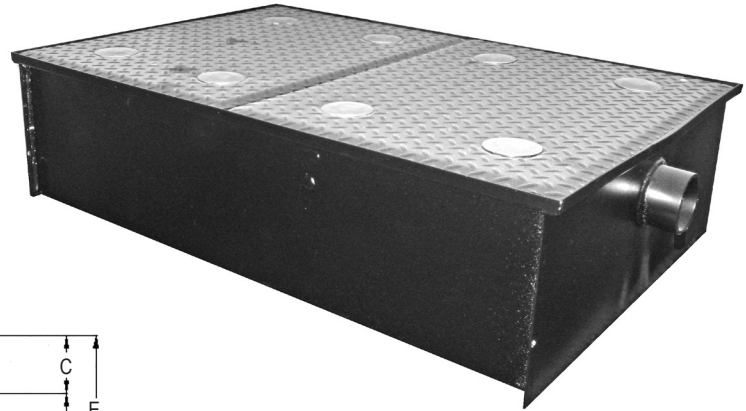

**Modifications are not available to dimensions of product.**

Choose MIFAB's MI-G-L Series for extensions, anchor flanges and other optional variations.

MODEL #	U.S. GPM	CAP LBS.	A	B	C	D	E	F	# LIDS	# OF BOLTS	LIST PRICE	WEIGHT LBS.
MCL-G-L-20	20	40 lbs.	34"	24"	4"	7"	11"	3"	1	4	\$1,305.00	45
MCL-G-L-35	35	50 lbs.	42"	28"	4"	7"	11"	3"	2	4	\$2,116.00	54

**6" BOLT ON EXTENSIONS**

Bolt On Extensions can be stacked in 6" increments.

MODEL #	LIST PRICE
MCL-G-BO-0-6	\$419.00
MCL-G-BO-1-6	\$472.00
MCL-G-BO-2-6	\$596.00
MCL-G-BO-3-6	\$627.00
MCL-G-BO-4-6	\$679.00
MCL-G-BO-5-6	\$730.00
MCL-G-BO-6-6	\$856.00
MCL-G-BO-7-6	\$1,358.00
XL-MCL-G-0-BO-6	\$2,294.00
XL-MCL-G-1-BO-6	\$2,607.00

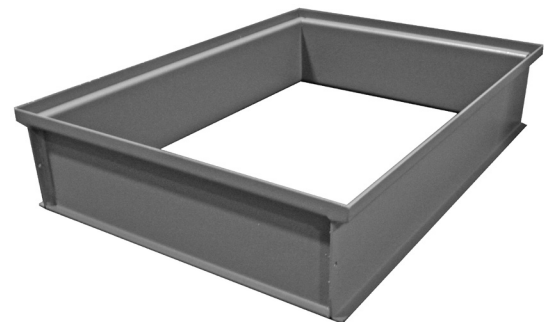

**NOTE:**

Custom Bolt On extensions can be manufactured upon request. Please contact MIFAB for pricing.

CALIFORNIA PROPOSITION 65 WARNING. This product contains chemicals known to the State of California to cause cancer and birth defects or other reproductive harm.

Design and dimensions are subject to modification. Prices do not include applicable taxes.

Visit [www.mifab.com](http://www.mifab.com) for the most recent product information.

MIFAB®, Inc., 1321 West 119th Street, Chicago, Illinois 60643-5109, USA

Toll Free: 1-800-465-2736, Fax: 1-773-341-3049

All sales subject to MIFAB's® Terms and Warranties. Please refer to page 3.

sales@mifab.com Canada Toll Free: 1-800-387-3880

## MI-ROC SERIES

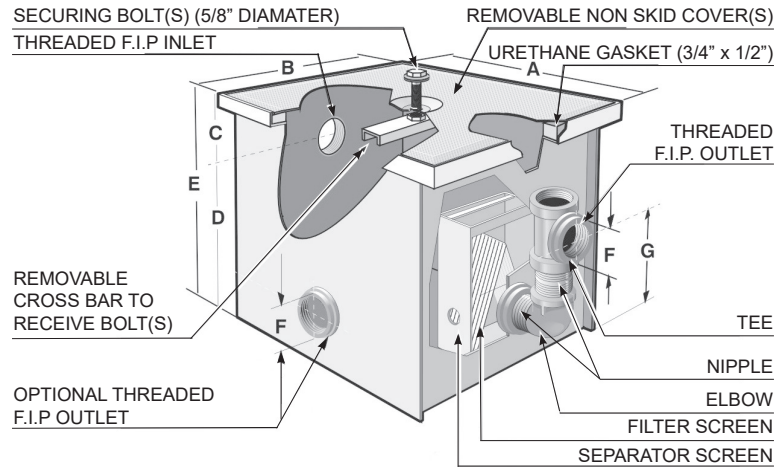

MI-ROC grease interceptors are manufactured with 10 gauge steel and coated with a powder acid resistant epoxy coating inside and out. Every interceptor has an F.I.P. inlet and outlet, cast iron drainage fittings to form a visible double wall deep seal trap, removable separator and filter screens, recessed, non-skid gasketed rectangular lid for in or above ground use, removable cross bar, securing bolt(s) and plugs for the outlet connections not required. No external or internal flow control is provided. The inlet is lower than the outlet. This results in water in the inlet piping that acts to slow water entering the interceptor.

*"The MI-ROC grease interceptor is a great alternative to standard interceptors at an economical price."*

– Tom Babcock, Kast Marketing, Chicago, IL

MI-ROC SERIES														
MODEL #	U.S. GPM	CAP (LBS.)	BODY DIMENSIONS - INCHES							LIQUID HOLDING CAP (U.S.G)	REPLACES ROCK FORD	NO. OF LIDS	NO. OF BOLTS	WEIGHT LBS.
			A	B	C	D	E	F	G					
MI-ROC-1	5	7	9 1/4"	6 1/4"	3 1/2"	5 1/2"	9"	1.5"	7 1/2"	2	G(F)-710	1	1	15
MI-ROC-2	8	12	10 1/4"	8 1/4"	3.88"	7.63"	11 1/2"	2"	9.63"	3.5	G(F)-1012	1	1	20
MI-ROC-3	12	18	12 3/4"	10 1/4"	4 1/2"	8.38"	12.88"	2"	10 3/4"	6	G(F)-1412	1	1	25
MI-ROC-4	16	60	18 1/2"	10 1/4"	4.88"	11"	15.88"	2"	13 3/4"	11.3	G(F)-1815	1	1	35
MI-ROC-5	20	70	20 1/4"	14 1/4"	5.88"	12"	17.88"	2"	15"	18.7	G(F)-1820	1	2	42
MI-ROC-6	30	90	24 1/2"	18 1/4"	6.13"	14 1/2"	20.63"	3"	17.88"	34.5	G(F)-2420	1	4	70
MI-ROC-7	35	120	24 1/2"	18 1/4"	8.63"	16 1/2"	25.13"	3"	20 3/4"	40	G(F)-2635	1	4	75
MI-ROC-8	40	180	26 1/4"	20 1/4"	7.88"	21 1/2"	29.38"	4"	25 3/4"	59	G(F)-2824	1	4	88
MI-ROC-9	50	220	29 1/2"	20 1/4"	7.88"	21 1/2"	29.38"	4"	25 3/4"	46.6	G(F)-3050	1	4	95
MI-ROC-10	60	250	33"	20 1/4"	7.88"	21 1/2"	29.38"	4"	25 3/4"	74.5	G(F)-3224	1	4	100
MI-ROC-11	75	300	33"	22 3/4"	8 1/2"	22"	30 1/2"	4"	26 1/4"	85.3	G(F)-3475	1	4	115
MI-ROC-12	100	350	35 1/2"	30"	8.13"	22"	30.13"	4"	26 1/4"	114.2	G(F)-3628	2	4	150
MI-ROC-LO SERIES														
MI-ROC-LO-1	16	65	20 1/4"	14 1/4"	4.63"	6"	10.63"	2"	8 3/4"	10.9	G(F)-23-LO	1	2	35
MI-ROC-LO-2	20	80	26 1/4"	20 1/4"	7.13"	6 1/2"	13.63"	2"	10 1/4"	23.6	G(F)-25-LO	2	2	60
MI-ROC-LO-3	30	90	30 1/4"	20 1/4"	7.13"	6 1/2"	13.63"	3"	10 1/4"	27.2	G(F)-30-LO	2	2	65
MI-ROC-LO-4	35	108	36 1/4"	20 1/4"	7.13"	6 1/2"	13.63"	3"	10 1/4"	32.6	G(F)-36-LO	2	2	72
MI-ROC-LO-5	40	200	44 1/2"	20 1/4"	5"	11"	16"	3"	11"	42.9	G(F)-45-LO	2	4	90
MI-ROC-LO-6	50	250	49 1/2"	20 1/4"	5"	11"	16"	3"	11"	47.7	G(F)-50-LO	2	4	95

OPTIONAL VARIATIONS			
SUFFIX	DESCRIPTION	SUFFIX	DESCRIPTION
-SS	Stainless Steel Interceptor	-AP	Anode Pack <b>(\$2,066.00 List)</b>
-FLC	Anchor Flange and Membrane Clamp	-F	Special Size Inlet and Outlet
-FL	Anchor Flange	-TL	Lid(s) to Receive Tile or Terrazo
-C	"C" as Required	-NH	MJ (No-Hub) Connections <b>(No Add)</b>
-SB	Sediment Bucket	-AL	Aluminum Lid(s)
-HD	Heavy Duty Reinforced Lid(s)	-DWLD	Leak Detection System <b>(\$4,130.00 List)</b>
-DW	Double Wall Contained Interceptor	-HLA	Liquid Level Alarm <b>(\$3,541.00 List)</b>

CALIFORNIA PROPOSITION 65 WARNING. This product contains chemicals known to the State of California to cause cancer and birth defects or other reproductive harm.



MI-ROC SERIES - GREASE INTERCEPTORS WITH 3 WAY OUTLET AND RECESSABLE LID									
MODEL #	ROCKFORD NUMBER	LIST PRICE	FIRST 6" Ext. (-C)	EACH 1" AFTER	SEDIMENT BUCKET (-SB)	FILTER MEDIUM (-FM)	REINFORCED COVER (-HD)	ANCHOR FLANGE (-FL)	MEMBRANE CLAMP (-C)
MI-ROC-1	G(F)-710, RTO-5	\$726.00	\$348.00	\$64.00	\$517.00	\$135.50	\$196.00	\$525.00	\$517.00
MI-ROC-2	G(F)-1012, RTO-8	\$741.00	\$348.00	\$64.00	\$517.00	\$135.50	\$196.00	\$525.00	\$517.00
MI-ROC-3	G(F)-1412, RTO-12	\$964.00	\$348.00	\$64.00	\$517.00	\$135.50	\$196.00	\$525.00	\$517.00
MI-ROC-4	G(F)-1815, RTO-16	\$1,380.00	\$389.00	\$67.50	\$517.00	\$135.50	\$211.00	\$627.00	\$616.00
MI-ROC-5	G(F)-1820, RTO-20	\$1,717.00	\$432.00	\$70.50	\$517.00	\$167.00	\$222.00	\$715.00	\$699.00
MI-ROC-6	G(F)-2420, RTO-30	\$2,291.00	\$510.00	\$86.25	\$551.00	\$187.00	\$246.00	\$748.00	\$736.00
MI-ROC-7	G(F)-2635, RTO-35	\$2,623.00	\$573.00	\$97.00	\$551.00	\$187.00	\$264.00	\$1,323.00	\$740.00
MI-ROC-8	G(F)-2824, RTO-40	\$3,402.00	\$731.00	\$116.75	\$673.00	\$246.00	\$305.00	\$1,511.00	\$770.00
MI-ROC-9	G(F)-3050, RTO-50	\$3,842.00	\$778.00	\$121.00	\$673.00	\$254.00	\$337.00	\$1,605.00	\$810.00
MI-ROC-10	G(F)-3224, RTO-60	\$4,822.00	\$820.00	\$131.25	\$673.00	\$370.00	\$381.00	\$1,666.00	\$825.00
MI-ROC-11	G(F)-3475, RTO-75	\$5,239.00	\$878.00	\$135.50	\$673.00	\$432.00	\$414.00	\$1,736.00	\$853.00
MI-ROC-12	G(F)-3628, RTO-100	\$6,407.00	\$897.00	\$145.00	\$673.00	\$460.00	\$481.00	\$1,805.00	\$878.00

NOTE: 3 way outlet w/ left hand, right hand and straight through outlets with every interceptor - plugs provided to thread into outlets not required. Cast iron drainage fittings and steel nipples included. Draw-off valve, add \$112.50 Net.

MI-ROC-LO SERIES - LOW ROUGH-IN GREASE INTERCEPTORS WITH RECESSABLE LID									
MODEL #	ROCKFORD NUMBER	LIST PRICE	FIRST 6" Ext. (-C)	EACH 1" AFTER	SEDIMENT BUCKET (-SB)	FILTER MEDIUM (-FM)	REINFORCED COVER (-HD)	ANCHOR FLANGE (-FL)	MEMBRANE CLAMP (-C)
MI-ROC-LO-1	G(F)-23-LO, RTO-16-LO	\$1,446.00	\$411.00	\$432.00	\$517.00	\$143.00	\$222.00	\$1,141.00	\$702.00
MI-ROC-LO-2	G(F)-25-LO, RTO-20-LO	\$2,057.00	\$696.00	\$731.00	\$517.00	\$149.00	\$305.00	\$1,510.00	\$770.00
MI-ROC-LO-3	G(F)-30-LO, RTO-30-LO	\$2,824.00	\$744.00	\$781.00	\$551.00	\$157.00	\$334.00	\$1,534.00	\$800.00
MI-ROC-LO-4	G(F)-36-LO	\$3,298.00	\$835.00	\$878.00	\$551.00	\$165.00	\$348.00	\$1,736.00	\$851.00
MI-ROC-LO-5	G(F)-45-LO, RTO-40-LO	\$3,930.00	\$932.00	\$979.00	\$551.00	\$184.00	\$364.00	\$1,883.00	\$889.00
MI-ROC-LO-6	G(F)-50-LO	\$4,394.00	\$1,072.00	\$1,127.00	\$551.00	\$194.00	\$382.00	\$2,065.00	\$925.00

### MI-ROC 6" BOLT ON EXTENSIONS

Bolt on extensions can be stacked in 6" increments.

MODEL #	LIST PRICE
MI-ROC-BO-1-6	\$450.00
MI-ROC-BO-2-6	\$569.00
MI-ROC-BO-3-6	\$601.00
MI-ROC-BO-4-6	\$623.00
MI-ROC-BO-5-6	\$649.00
MI-ROC-BO-6-6	\$700.00
MI-ROC-BO-7-6	\$818.00
MI-ROC-BO-8-6	\$1,203.00
MI-ROC-BO-9-6	\$1,295.00
MI-ROC-BO-10-6	\$1,781.00
MI-ROC-BO-11-6	\$2,191.00
MI-ROC-BO-12-6	\$2,489.00

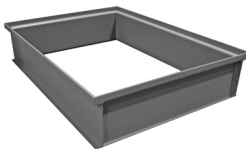

#### Bolt On Extension

Note: Custom bolt on extensions can be manufactured upon request. Please contact MIFAB for pricing.

### MI-GO SERIES - RESIDENTIAL GREASE INTERCEPTORS WITH WRAP AROUND LID

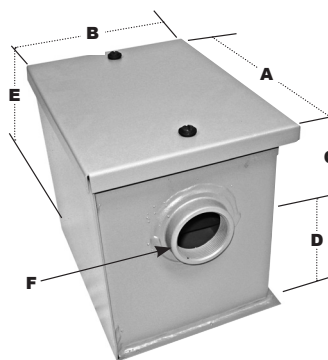

MI-GO-1 steel interceptor illustrated



MI-GO-1-PL HDPE interceptor illustrated

MIFAB #	ROCKFORD	HICO	LIST PRICE	US GPM	CAP LBS.	OVERALL DIMENSIONS					
						A	B	C	D	E	F
MI-GO-1	NO ALT.	NO ALT.	\$258.50	8	12	11 1/2"	8 3/4"	3 3/4"	6 1/2"	10 1/4"	2" F.I.P.
MI-GO-2	G-1012	3630	\$769.00	8	12	11 1/2"	8 3/4"	4 1/4"	6"	10 1/4"	2" F.I.P.
MI-GO-3	G-1815	3631	\$1,408.00	16	60	18 7/8"	10 3/4"	4 1/2"	11"	15 1/2"	2" F.I.P.
MI-GO-4	G-1820	3632	\$1,790.00	20	70	20 3/4"	14 3/4"	6"	12"	16"	2" F.I.P.
MI-GO-1-PL	NO ALT.	NO ALT.	\$328.00	8	12	11 1/2"	8 3/4"	3 3/4"	6 1/2"	10 1/4"	2" F.I.P.

CALIFORNIA PROPOSITION 65 WARNING. This product contains chemicals known to the State of California to cause cancer and birth defects or other reproductive harm.

Design and dimensions are subject to modification. Prices do not include applicable taxes.

Visit [www.mifab.com](http://www.mifab.com) for the most recent product information.

MIFAB®, Inc., 1321 West 119th Street, Chicago, Illinois 60643-5109, USA

Toll Free: 1-800-465-2736, Fax: 1-773-341-3049

All sales subject to MIFAB's® Terms and Warranties. Please refer to page 3.

sales@mifab.com Canada Toll Free: 1-800-387-3880



**LIDS FOR MCL SERIES GREASE INTERCEPTORS**

MODEL #	DESCRIPTION	BOLTS FOR LID REQ.	LIST PRICE
MCL-G-0-LID	Epoxy Lid for MCL-G-0	1	\$261.00
MCL-G-1-LID	Epoxy Lid for MCL-G-1	1	\$291.00
MCL-G-2-LID	Epoxy Lid for MCL-G-2	1	\$348.00
MCL-G-3-LID	Epoxy Lid for MCL-G-3	1	\$407.00
MCL-G-4-LID	Epoxy Lid for MCL-G-4	1	\$493.00
MCL-G-5-LID	Epoxy Lid for MCL-G-5	1	\$667.00
MCL-G-6-LID	Epoxy Lid for MCL-G-6	4	\$811.00
MCL-G-7-LID	Epoxy Lid for MCL-G-7	4	\$927.00
XL-MCL-G-0-LID	Epoxy Lids for XL-MCL-G-0	8	\$1,159.00
XL-MCL-G-1-LID	Epoxy Lids for XL-MCL-G-1	8	\$1,274.00
MCL-G-L-20-LID	Epoxy Lid for MCL-G-L-20	4	\$695.00
MCL-G-L-35-LID	Epoxy Lids for MCL-G-L-35	4	\$1,043.00

**CROSS BARS FOR MCL SERIES GREASE INTERCEPTORS**

MODEL #	DESCRIPTION	LIST PRICE
MCL-G-0-XBAR	Cross Bar & Cotter Pins for MCL-G-0	\$117.00
MCL-G-1-XBAR	Cross Bar & Cotter Pins for MCL-G-1	\$128.00
MCL-G-2-XBAR	Cross Bar & Cotter Pins for MCL-G-2	\$140.00
MCL-G-3-XBAR	Cross Bar & Cotter Pins for MCL-G-3	\$152.00
MCL-G-4-XBAR	Cross Bar & Cotter Pins for MCL-G-4	\$163.00
MCL-G-5-XBAR	Cross Bar & Cotter Pins for MCL-G-5	\$175.00
MCL-G-6-XBAR	Cross Bar & Cotter Pin set for MCL-G-6	\$186.00
MCL-G-7-XBAR	Cross Bar & Cotter Pin set for MCL-G-7	\$204.00
XL-MCL-G-0-XBAR	Cross Bar & Cotter Pin set for XL-MCL-G-0	\$348.00
XL-MCL-G-1-XBAR	Cross Bar & Cotter Pin set for XL-MCL-G-1	\$463.00
MCL-G-L-20-XBAR	Cross Bar & Cotter Pin set for MCL-G-L-20	\$163.00
MCL-G-L-35-XBAR	Cross Bar & Cotter Pin set for MCL-G-L-35	\$186.00

**CROSS BARS FOR MCL SERIES GREASE INTERCEPTORS**

MODEL #	DESCRIPTION	LIST PRICE
FLCT-0	2" IPS 4 GPM FLOW CONTROL FITTING	\$117.00
FLCT-1	2" IPS 7 GPM FLOW CONTROL FITTING	\$128.00
FLCT-2	2" IPS 10 GPM FLOW CONTROL FITTING	\$140.00
FLCT-3	2" IPS 15 GPM FLOW CONTROL FITTING	\$152.00
FLCT-4	3" IPS 20 GPM FLOW CONTROL FITTING	\$163.00
FLCT-5	3" IPS 25 GPM FLOW CONTROL FITTING	\$175.00
FLCT-6	3" IPS 35 GPM FLOW CONTROL FITTING	\$186.00
FLCT-7	3" IPS 50 GPM FLOW CONTROL FITTING	\$204.00
FLCT-XL-0	4" IPS 75 GPM FLOW CONTROL FITTING	\$348.00
FLCT-XL-1	4" IPS 100 GPM FLOW CONTROL FITTING	\$463.00
FLC-0	2" NH 4 GPM FLOW CONTROL FITTING	\$117.00
FLC-1	2" NH 7 GPM FLOW CONTROL FITTING	\$128.00
FLC-2	2" NH 10 GPM FLOW CONTROL FITTING	\$140.00
FLC-3	2" NH 15 GPM FLOW CONTROL FITTING	\$152.00
FLC-4	3" NH 20 GPM FLOW CONTROL FITTING	\$163.00
FLC-5	3" NH 25 GPM FLOW CONTROL FITTING	\$175.00
FLC-6	3" NH 35 GPM FLOW CONTROL FITTING	\$186.00
FLC-7	3" NH 50 GPM FLOW CONTROL FITTING	\$204.00
FLC-XL-0	4" NH 75 GPM FLOW CONTROL FITTING	\$348.00
FLC-XL-1	4" NH 100 GPM FLOW CONTROL FITTING	\$463.00

**LIDS FOR MI-ROC SERIES GREASE INTERCEPTORS**

MODEL #	DESCRIPTION	BOLTS FOR LID REQ.	LIST PRICE
MI-ROC-1-LID	Epoxy Lid for MI-ROC-1	1	\$261.00
MI-ROC-2-LID	Epoxy Lid for MI-ROC-2	1	\$291.00
MI-ROC-3-LID	Epoxy Lid for MI-ROC-3	1	\$348.00
MI-ROC-4-LID	Epoxy Lid for MI-ROC-4	1	\$407.00
MI-ROC-5-LID	Epoxy Lid for MI-ROC-5	2	\$493.00
MI-ROC-6-LID	Epoxy Lid for MI-ROC-6	4	\$667.00
MI-ROC-7-LID	Epoxy Lid for MI-ROC-7	4	\$811.00
MI-ROC-8-LID	Epoxy Lid for MI-ROC-8	4	\$927.00
MI-ROC-9-LID	Epoxy Lid for MI-ROC-9	4	\$1,159.00
MI-ROC-10-LID	Epoxy Lid for MI-ROC-10	4	\$1,274.00
MI-ROC-11-LID	Epoxy Lid for MI-ROC-11	4	\$1,390.00
MI-ROC-12-LID	Epoxy Lids for MI-ROC-12	4	\$1,506.00
MI-ROC-LO-1-LID	Epoxy Lid for MI-ROC-LO-1	2	\$261.00

MI-ROC-LO-2-LID	Epoxy Lids for MI-ROC-LO-2	2	\$291.00
MI-ROC-LO-3-LID	Epoxy Lids for MI-ROC-LO-3	2	\$348.00
MI-ROC-LO-4-LID	Epoxy Lids for MI-ROC-LO-4	2	\$407.00
MI-ROC-LO-5-LID	Epoxy Lids for MI-ROC-LO-5	4	\$493.00
MI-ROC-LO-6-LID	Epoxy Lids for MI-ROC-LO-6	4	\$667.00

**CROSS BARS FOR MI-ROC SERIES GREASE INTERCEPTORS**

Part#	DESCRIPTION	LIST PRICE
MI-ROC-1-XBAR	Cross Bar & Cotter Pins for MI-ROC-1	\$117.00
MI-ROC-2-XBAR	Cross Bar & Cotter Pins for MI-ROC-2	\$128.00
MI-ROC-3-XBAR	Cross Bar & Cotter Pins for MI-ROC-3	\$140.00
MI-ROC-4-XBAR	Cross Bar & Cotter Pins for MI-ROC-4	\$152.00
MI-ROC-5-XBAR	Cross Bar & Cotter Pin set for MI-ROC-5	\$163.00
MI-ROC-6-XBAR	Cross Bar & Cotter Pin set for MI-ROC-6	\$175.00
MI-ROC-7-XBAR	Cross Bar & Cotter Pin set for MI-ROC-7	\$186.00
MI-ROC-8-XBAR	Cross Bar & Cotter Pin set for MI-ROC-8	\$204.00
MI-ROC-9-XBAR	Cross Bar & Cotter Pin set for MI-ROC-9	\$232.00
MI-ROC-10-XBAR	Cross Bar & Cotter Pin set for MI-ROC-10	\$291.00
MI-ROC-11-XBAR	Cross Bar & Cotter Pin set for MI-ROC-11	\$348.00
MI-ROC-12-XBAR	Cross Bar & Cotter Pin set for MI-ROC-12	\$407.00
MI-ROC-LO-1-XBAR	Cross Bar & Cotter Pins for MI-ROC-LO-1	\$117.00
MI-ROC-LO-2-XBAR	Cross Bar & Cotter Pin set for MI-ROC-LO-2	\$128.00
MI-ROC-LO-3-XBAR	Cross Bar & Cotter Pin set for MI-ROC-LO-3	\$140.00
MI-ROC-LO-4-XBAR	Cross Bar & Cotter Pin set for MI-ROC-LO-4	\$152.00
MI-ROC-LO-5-XBAR	Cross Bar & Cotter Pin set for MI-ROC-LO-5	\$163.00
MI-ROC-LO-6-XBAR	Cross Bar & Cotter Pin set for MI-ROC-LO-6	\$175.00

**SEDIMENT BUCKETS FOR MI-ROC SERIES GREASE INTERCEPTORS**

Part#	DESCRIPTION	LIST PRICE
MI-ROC-1-BUCKET-SB	Sediment Bucket w/Filter Screen for MI-ROC-1	\$261.00
MI-ROC-2-BUCKET-SB	Sediment Bucket w/Filter Screen for MI-ROC-2	\$291.00
MI-ROC-3-BUCKET-SB	Sediment Bucket w/Filter Screen for MI-ROC-3	\$348.00
MI-ROC-4-BUCKET-SB	Sediment Bucket w/Filter Screen for MI-ROC-4	\$407.00
MI-ROC-5-BUCKET-SB	Sediment Bucket w/Filter Screen for MI-ROC-5	\$493.00
MI-ROC-6-BUCKET-SB	Sediment Bucket w/Filter Screen for MI-ROC-6	\$667.00
MI-ROC-7-BUCKET-SB	Sediment Bucket w/Filter Screen for MI-ROC-7	\$811.00
MI-ROC-8-BUCKET-SB	Sediment Bucket w/Filter Screen for MI-ROC-8	\$927.00
MI-ROC-9-BUCKET-SB	Sediment Bucket w/Filter Screen for MI-ROC-9	\$1,159.00
MI-ROC-10-BUCKET-SB	Sediment Bucket w/Filter Screen for MI-ROC-10	\$1,274.00
MI-ROC-11-BUCKET-SB	Sediment Bucket w/Filter Screen for MI-ROC-11	\$1,390.00
MI-ROC-12-BUCKET-SB	Sediment Bucket w/Filter Screen for MI-ROC-12	\$1,506.00
MI-ROC-LO-1-BUCKET-SB	Sediment Bucket w/Filter Screen for MI-ROC-LO-1	\$261.00
MI-ROC-LO-2-BUCKET-SB	Sediment Bucket w/Filter Screen for MI-ROC-LO-2	\$291.00
MI-ROC-LO-3-BUCKET-SB	Sediment Bucket w/Filter Screen for MI-ROC-LO-3	\$348.00
MI-ROC-LO-4-BUCKET-SB	Sediment Bucket w/Filter Screen for MI-ROC-LO-4	\$407.00
MI-ROC-LO-5-BUCKET-SB	Sediment Bucket w/Filter Screen for MI-ROC-LO-5	\$493.00
MI-ROC-LO-6-BUCKET-SB	Sediment Bucket w/Filter Screen for MI-ROC-LO-6	\$667.00

**FILTER SCREENS FOR MI-ROC SERIES GREASE INTERCEPTORS**

Part#	DESCRIPTION	LIST PRICE
MI-ROC-1-FILTER	Filter Screen Piece for MI-ROC-1	\$175.00
MI-ROC-2-FILTER	Filter Screen Piece for MI-ROC-2	\$232.00
MI-ROC-3-FILTER	Filter Screen Piece for MI-ROC-3	\$291.00
MI-ROC-4-FILTER	Filter Screen Piece for MI-ROC-4	\$348.00
MI-ROC-5-FILTER	Filter Screen Piece for MI-ROC-5	\$407.00
MI-ROC-6-FILTER	Filter Screen Piece for MI-ROC-6	\$463.00
MI-ROC-7-FILTER	Filter Screen Piece for MI-ROC-7	\$522.00
MI-ROC-8-FILTER	Filter Screen Piece for MI-ROC-8	\$580.00
MI-ROC-9-FILTER	Filter Screen Piece for MI-ROC-9	\$638.00
MI-ROC-10-FILTER	Filter Screen Piece for MI-ROC-10	\$695.00
MI-ROC-11-FILTER	Filter Screen Piece for MI-ROC-11	\$753.00
MI-ROC-12-FILTER	Filter Screen Piece for MI-ROC-12	\$811.00
MI-ROC-LO-1-FILTER	Filter Screen Piece for MI-ROC-LO-1	\$175.00
MI-ROC-LO-2-FILTER	Filter Screen Piece for MI-ROC-LO-2	\$232.00
MI-ROC-LO-3-FILTER	Filter Screen Piece for MI-ROC-LO-3	\$239.00
MI-ROC-LO-4-FILTER	Filter Screen Piece for MI-ROC-LO-4	\$348.00
MI-ROC-LO-5-FILTER	Filter Screen Piece for MI-ROC-LO-5	\$407.00
MI-ROC-LO-6-FILTER	Filter Screen Piece for MI-ROC-LO-6	\$463.00

CALIFORNIA PROPOSITION 65 WARNING. This product contains chemicals known to the State of California to cause cancer and birth defects or other reproductive harm.

### HY-1000-NPB NON FREEZE WALL HYDRANT

The HY-1000-NPB Series hydrants feature a combination 3/4" SWT. and 3/4" M.I.P. inlet connection that swivels 360° to any position for easy connection to the water supply. The swivel connection can be removed for a straight back 1/2" SWT. inlet connection.

MODEL #	DESCRIPTION	LIST PRICE	SUFFIX (ADD) -HC1 (See page 31)	SUFFIX (ADD) -WC (See page 31)	WEIGHT LBS.
HY-1004-NPB	Non freeze, exposed, 4"	\$344.00	\$38.75	\$24.50	5
HY-1006-NPB	Non freeze, exposed, 6"	\$344.00	\$38.75	\$24.50	6
HY-1008-NPB	Non freeze, exposed, 8"	\$344.00	\$38.75	\$24.50	7
HY-1010-NPB	Non freeze, exposed, 10"	\$367.00	\$38.75	\$24.50	7.5
HY-1012-NPB	Non freeze, exposed, 12"	\$367.00	\$38.75	\$24.50	8
HY-1014-NPB	Non freeze, exposed, 14"	\$367.00	\$38.75	\$24.50	8
HY-1016-NPB	Non freeze, exposed, 16"	\$367.00	\$38.75	\$24.50	9
HY-1018-NPB	Non freeze, exposed, 18"	\$388.00	\$38.75	\$24.50	10
HY-1020-NPB	Non freeze, exposed, 20"	\$388.00	\$38.75	\$24.50	11
HY-1022-NPB	Non freeze, exposed, 22"	\$388.00	\$38.75	\$24.50	11
HY-1024-NPB	Non freeze, exposed, 24"	\$388.00	\$38.75	\$24.50	12



### HY-2000-NPB ENCASED NON FREEZE WALL HYDRANT

The HY-2000-NPB Series hydrants feature a combination 3/4" SWT. and 3/4" M.I.P. inlet connection that swivels 360° to any position for easy connection to the water supply. The swivel connection can be removed for a straight back 1/2" SWT. inlet connection.

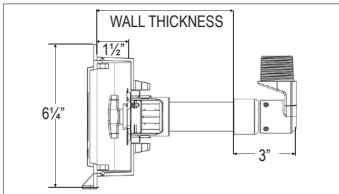

RECOMMENDED WALL  
OPENING:  
**5 1/4" x 6 1/4"**  
OVERALL BOX DEPTH - 1 1/2"



MODEL #	DESCRIPTION	LIST PRICE	SUFFIX (ADD) -HC1 (See page 31)	SUFFIX (ADD) -WC (See page 31)	SUFFIX (ADD) -K (See page 31)	SUFFIX (ADD) -S (See page 31)	WEIGHT LBS.
HY-2006-NPB	Non freeze, encased, 6"	\$684.00	\$38.75	\$24.50	\$63.00	NO ADD	7
HY-2008-NPB	Non freeze, encased, 8"	\$684.00	\$38.75	\$24.50	\$63.00	NO ADD	8
HY-2010-NPB	Non freeze, encased, 10"	\$706.00	\$38.75	\$24.50	\$63.00	NO ADD	9
HY-2012-NPB	Non freeze, encased, 12"	\$706.00	\$38.75	\$24.50	\$63.00	NO ADD	9.5
HY-2014-NPB	Non freeze, encased, 14"	\$706.00	\$38.75	\$24.50	\$63.00	NO ADD	10
HY-2016-NPB	Non freeze, encased, 16"	\$706.00	\$38.75	\$24.50	\$63.00	NO ADD	10
HY-2018-NPB	Non freeze, encased, 18"	\$728.00	\$38.75	\$24.50	\$63.00	NO ADD	11
HY-2020-NPB	Non freeze, encased, 20"	\$728.00	\$38.75	\$24.50	\$63.00	NO ADD	12
HY-2022-NPB	Non freeze, encased, 22"	\$728.00	\$38.75	\$24.50	\$63.00	NO ADD	13
HY-2024-NPB	Non freeze, encased, 24"	\$728.00	\$38.75	\$24.50	\$63.00	NO ADD	13
HY-2026-NPB	Non freeze, encased, 26"	\$728.00	\$38.75	\$24.50	\$63.00	NO ADD	14

### HY-3000-NPB MODERATE CLIMATE WALL HYDRANT with 3/4" F.I.P. and 1" M.I.P. WATER SUPPLY INLET CONNECTION

MODEL #	DESCRIPTION	LIST PRICE	SUFFIX (ADD) -HC1 (See page 31)	WEIGHT LBS.
HY-3000-NPB	Moderate climate, exposed	\$279.00	\$38.75	3.0 lbs.



### HY-3500-NPB ENCASED MODERATE CLIMATE WALL HYDRANT with 3/4" F.I.P. and 1" M.I.P. WATER SUPPLY INLET CONNECTION

"MIFAB's unique 360 degree swivel wall hydrant design is the most versatile the industry offers. It makes for easy installation from any direction."

- Dewey Ayers, Sales Professional,  
Maumee Supply, Cleveland, OH

RECOMMENDED WALL OPENING:  
**5 1/4" x 6 1/4"**  
OVERALL BOX DEPTH - 1 1/2"

MODEL #	DESCRIPTION	LIST PRICE	SUFFIX (ADD) -HC1 (See page 31)	SUFFIX (ADD) -K (See page 31)	SUFFIX (ADD) -S (See page 31)	WEIGHT LBS.
HY-3500-NPB	Moderate climate, encased	\$619.00	\$38.75	\$63.00	NO ADD	5

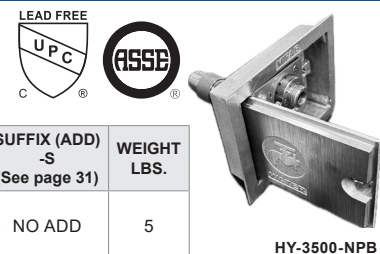

CALIFORNIA PROPOSITION 65 WARNING. This product contains chemicals known to the State of California to cause cancer and birth defects or other reproductive harm.

Design and dimensions are subject to modification. Prices do not include applicable taxes.

Visit [www.mifab.com](http://www.mifab.com) for the most recent product information.

MIFAB<sup>®</sup>, Inc., 1321 West 119th Street, Chicago, Illinois 60643-5109, USA  
All sales subject to MIFAB's<sup>®</sup> Terms and Warranties. Please refer to page 3.

Toll Free: 1-800-465-2736, Fax: 1-773-341-3049  
sales@mifab.com Canada Toll Free: 1-800-387-3880

### HY-4000-NPB

### HOT AND COLD COMMERCIAL NON-FREEZE WALL HYDRANT with 3/4" F.I.P. and 1" M.I.P. WATER SUPPLY INLET CONNECTION



MODEL #	DESCRIPTION	LIST PRICE	SUFFIX (ADD) -HC1 (See page 31)	SUFFIX (ADD) -WC (See page 31)	WEIGHT LBS.
HY-4004-NPB	Hot and cold, exposed, 4"	\$853.00	\$38.75	\$24.50	6
HY-4006-NPB	Hot and cold, exposed, 6"	\$853.00	\$38.75	\$24.50	7
HY-4008-NPB	Hot and cold, exposed, 8"	\$853.00	\$38.75	\$24.50	8
HY-4010-NPB	Hot and cold, exposed, 10"	\$879.00	\$38.75	\$24.50	8.5
HY-4012-NPB	Hot and cold, exposed, 12"	\$879.00	\$38.75	\$24.50	9
HY-4014-NPB	Hot and cold, exposed, 14"	\$879.00	\$38.75	\$24.50	10
HY-4016-NPB	Hot and cold, exposed, 16"	\$879.00	\$38.75	\$24.50	11
HY-4018-NPB	Hot and cold, exposed, 18"	\$907.00	\$38.75	\$24.50	12
HY-4020-NPB	Hot and cold, exposed, 20"	\$907.00	\$38.75	\$24.50	14
HY-4022-NPB	Hot and cold, exposed, 22"	\$907.00	\$38.75	\$24.50	15
HY-4024-NPB	Hot and cold, exposed, 24"	\$907.00	\$38.75	\$24.50	16

### HY-4500-NPB

### ENCASED HOT AND COLD COMMERCIAL NON-FREEZE WALL HYDRANT with 1" M.I.P. & 3/4" SWT. WATER SUPPLY INLET CONNECTION



RECOMMENDED WALL OPENING:  
7 5/8" x 5 3/4". OVERALL BOX DEPTH - 3 5/8"

MODEL #	DESCRIPTION	LIST PRICE	SUFFIX (ADD) -HC1 (See page 31)	SUFFIX (ADD) -WC (See page 31)	SUFFIX (ADD) -K (See page 31)	WEIGHT LBS.
HY-4508-NPB	Hot and cold, commercial, encased, 8"	\$1,384.00	\$38.75	\$24.50	\$63.00	16
HY-4510-NPB	Hot and cold, commercial, encased, 10"	\$1,409.00	\$38.75	\$24.50	\$63.00	17
HY-4512-NPB	Hot and cold, commercial, encased, 12"	\$1,409.00	\$38.75	\$24.50	\$63.00	18
HY-4514-NPB	Hot and cold, commercial, encased, 14"	\$1,409.00	\$38.75	\$24.50	\$63.00	18.5
HY-4516-NPB	Hot and cold, commercial, encased, 16"	\$1,409.00	\$38.75	\$24.50	\$63.00	19
HY-4518-NPB	Hot and cold, commercial, encased, 18"	\$1,435.00	\$38.75	\$24.50	\$63.00	20
HY-4520-NPB	Hot and cold, commercial, encased, 20"	\$1,435.00	\$38.75	\$24.50	\$63.00	21
HY-4522-NPB	Hot and cold, commercial, encased, 22"	\$1,435.00	\$38.75	\$24.50	\$63.00	22
HY-4524-NPB	Hot and cold, commercial, encased, 24"	\$1,435.00	\$38.75	\$24.50	\$63.00	24
HY-4526-NPB	Hot and cold, commercial, encased, 26"	\$1,435.00	\$38.75	\$24.50	\$63.00	25
HY-4528-NPB	Hot and cold, commercial, encased, 28"	\$1,435.00	\$38.75	\$24.50	\$63.00	26

### HY-5000-NPB

### NARROW WALL MODERATE CLIMATE WALL HYDRANT



HY-5000-NPB Tail



The HY-5000-NPB Series hydrants feature a combination 3/4" SWT. and 3/4" M.I.P. inlet connection that swivels 360° to any position for easy connection to the water supply. The overall depth of the HY-5000-NPB is 2 5/8".

MODEL #	DESCRIPTION	LIST PRICE	SUFFIX (ADD) -HC1 (See page 31)	WEIGHT LBS.
HY-5000-NPB	Narrow wall, exposed	\$252.00	\$38.75	3.25 lbs.

*"The MIFAB narrow wall hydrant is perfect for an under counter restroom wash down hydrant. With an overall depth of 2-5/8" it easily fits inside a 2" x 4" wall with or without tile."*

– Steve Calhoun, Principal, Blackjack Mountain Marketing, Inc., Little Rock, AR

### HY-5500-NPB

### ENCASED NARROW WALL MODERATE CLIMATE WALL HYDRANT

HY-5500-NPB 360° swivel inlet

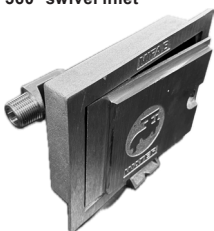

The HY-5500-NPB Series hydrants feature a combination 3/4" SWT. and 3/4" M.I.P. inlet connection that swivels 360° to any position for easy connection to the water supply.

RECOMMENDED WALL OPENING:  
5 1/4" x 6 1/4". OVERALL BOX DEPTH - 3 15/16"

MODEL #	DESCRIPTION	LIST PRICE	SUFFIX (ADD) -HC1 (See page 31)	SUFFIX (ADD) -K (See page 31)	SUFFIX (ADD) -S (See page 31)	WEIGHT LBS.
HY-5500-NPB	Moderate climate, narrow wall, encased	\$589.00	\$38.75	\$63.00	NO ADD	5.25

CALIFORNIA PROPOSITION 65 WARNING. This product contains chemicals known to the State of California to cause cancer and birth defects or other reproductive harm.

### HY-5800 ROOF HYDRANT

MODEL #	DESCRIPTION	OVERALL LENGTH	LIST PRICE	WEIGHT LBS.
HY-5800	Roof Hydrant	54"	\$1,193.00	30



### HY-6000-NPB GROUND / LAWN HYDRANT

RECOMMENDED GROUND OPENING - 5 1/4" x 6 1/4".

MODEL #	DESCRIPTION	LIST PRICE	SUFFIX (ADD) -HC1 (See page 31)	SUFFIX (ADD) -K (See page 31)	WEIGHT LBS.
HY-6001-NPB	Ground hydrant, 1' bury	\$799.00	\$38.75	\$63.00	10
HY-6002-NPB	Ground hydrant, 2' bury	\$799.00	\$38.75	\$63.00	13
HY-6003-NPB	Ground hydrant, 3' bury	\$825.00	\$38.75	\$63.00	16
HY-6004-NPB	Ground hydrant, 4' bury	\$837.00	\$38.75	\$63.00	19
HY-6005-NPB	Ground hydrant, 5' bury	\$852.00	\$38.75	\$63.00	22
HY-6006-NPB	Ground hydrant, 6' bury	\$865.00	\$38.75	\$63.00	25
HY-6007-NPB	Ground hydrant, 7' bury	\$880.00	\$38.75	\$63.00	28

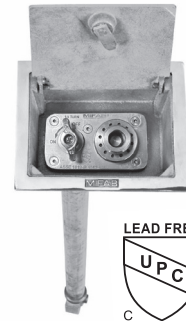

MODEL #	DESCRIPTION	LIST PRICE
HY-60-RK	Repair kit for HY-6000-NPB	\$191.00

### HY-6500-NPB POST HYDRANT

MODEL #	DESCRIPTION	OVERALL LENGTH	LIST PRICE	WEIGHT LBS.
HY-6501-NPB	Post hydrant, 1' bury	36"	\$342.00	20
HY-6502-NPB	Post hydrant, 2' bury	48"	\$355.00	24
HY-6503-NPB	Post hydrant, 3' bury	60"	\$367.00	28
HY-6504-NPB	Post hydrant, 4' bury	72"	\$377.00	32
HY-6505-NPB	Post hydrant, 5' bury	84"	\$388.00	36
HY-6506-NPB	Post hydrant, 6' bury	96"	\$398.00	40
HY-6507-NPB	Post hydrant, 7' bury	108"	\$410.00	44



MODEL #	DESCRIPTION	LIST PRICE
HY-65-RK	Repair kit for HY-6500-NPB	\$225.00
HY-9005-B-NPB	A.S.S.E. 1011 Approved Rough Brass Vacuum Breaker	\$30.00



### HY-6800-NPB YARD HYDRANT

MODEL #	DESCRIPTION	OVERALL LENGTH	LIST PRICE	SUFFIX (ADD) -HC1 (See page 31)	SUFFIX (ADD) -VB (See page 31)	WEIGHT LBS.
HY-6801-NPB	Yard hydrant, 1' bury	36"	\$189.00	\$38.75	\$24.50	10
HY-6802-NPB	Yard hydrant, 2' bury	48"	\$199.00	\$38.75	\$24.50	12
HY-6803-NPB	Yard hydrant, 3' bury	60"	\$210.00	\$38.75	\$24.50	17
HY-6804-NPB	Yard hydrant, 4' bury	72"	\$220.00	\$38.75	\$24.50	19
HY-6805-NPB	Yard hydrant, 5' bury	84"	\$233.00	\$38.75	\$24.50	22
HY-6806-NPB	Yard hydrant, 6' bury	96"	\$244.00	\$38.75	\$24.50	24
HY-6807-NPB	Yard hydrant, 7' bury	108"	\$254.00	\$38.75	\$24.50	26
HY-6808-NPB	Yard hydrant, 8' bury	120"	\$266.00	\$38.75	\$24.50	28



MODEL #	DESCRIPTION	LIST PRICE
HY-68-RK	Repair kit for HY-6800-NPB	\$197.00
HY-9005-B-NPB	A.S.S.E. 1011 Approved Rough Brass Vacuum Breaker	\$24.50



*"The 360-degree swivel tailpiece connection with triple O-ring seals on MIFAB hydrants allows my customers a safer, faster, and easier installation keeping them from having to sweat an elbow on the end."*

- Tim Mulholland, Engineering Specialist, Mullen Corporation, Tampa FL

CALIFORNIA PROPOSITION 65 WARNING. This product contains chemicals known to the State of California to cause cancer and birth defects or other reproductive harm.

Design and dimensions are subject to modification. Prices do not include applicable taxes.

Visit [www.mifab.com](http://www.mifab.com) for the most recent product information.

MIFAB<sup>®</sup>, Inc., 1321 West 119th Street, Chicago, Illinois 60643-5109, USA

Toll Free: 1-800-465-2736, Fax: 1-773-341-3049

All sales subject to MIFAB's<sup>®</sup> Terms and Warranties. Please refer to page 3.

sales@mifab.com Canada Toll Free: 1-800-387-3880

### HY-9000-NPB

### ROUGH BRASS WALL FAUCET with VACUUM BREAKER

Illustrated with brown plastic wheel handle

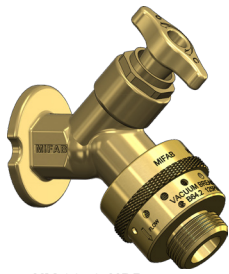

HY-9040-NPB



MODEL #	FINISH	OPERATING DEVICE	INLET CONNECTION	LIST PRICE	WEIGHT LBS.
HY-9040-NPB	Rough brass	Operating loose tee key, cast iron wheel handle, brown plastic and clear plastic wheel handle all included	1/2" F.P.T.	\$78.00	1.25
HY-9041-NPB	Rough brass	Operating loose tee key, cast iron wheel handle, brown plastic and clear plastic wheel handle all included	3/4" F.P.T.	\$78.00	1.25
HY-90-RK	Repair kit for HY-9000-NPB of Hydrants			\$31.50	
HY-9000-VB	A.S.S.E. 1011 Approved Rough Brass Vacuum Breaker (to replace vacuum breaker on the HY-9040-NPB or HY-9041-NPB)			\$24.50	

*"MIFAB has taken the guess work out of which handle needs to be ordered with the HY-9000 wall faucet. They include 4 handle types with every order so our customers get to choose the correct one."*

- Hans Haas, Principal, SPEC 22 Sales, Charlotte, NC

 <b>Part # HY-9001</b> Brown Plastic Wheel Handle	 <b>Part # HY-9002</b> Clear Plastic Wheel Handle	 <b>Part # HY-9003</b> Cast Iron Wheel Handle	 <b>Part # HY-9004</b> Loose Tee Key
--	--	---	---

**Note:** All four of the above handles are shipped with every HY-9040-NPB, HY-9041-NPB, HY-9240-NPB, and HY-9241-NPB.

### HY-9200-NPB

### POLISHED CHROME PLATED WALL FAUCET with VACUUM BREAKER

Illustrated with brown plastic wheel handle



HY-9241-NPB



MODEL #	FINISH	OPERATING DEVICE	CONNECTION	LIST PRICE	WEIGHT LBS.
HY-9240-NPB	Polished Chrome Plated	Operating loose tee key, cast iron wheel handle, brown plastic and clear plastic wheel handle all included	1/2" F.P.T.	\$102.00	1.25
HY-9241-NPB	Polished Chrome Plated	Operating loose tee key, cast iron wheel handle, brown plastic and clear plastic wheel handle all included	3/4" F.P.T.	\$102.00	1.25
MODEL #	DESCRIPTION			LIST PRICE	
HY-90-RK	Repair kit for HY-9200-NPB of Hydrants			\$33.00	
HY-9000-VB-49	A.S.S.E. 1011 Approved Polished Chrome Plated Vacuum Breaker (to replace vacuum breaker on the HY-9240-NPB or HY-9241-NPB)			\$24.50	

### HY-9500

### HYDRANT BOXES FOR WALL FAUCETS

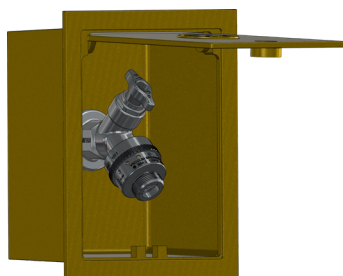

HY-9241-NPB with HY-9500

MODEL #	DESCRIPTION	LIST PRICE	WEIGHT LBS.
HY-9500	Rough Brass box only - hydrant extra	\$392.00	10
HY-9500-49	Chrome Plated Brass box only - hydrant extra	\$574.00	10
HY-9500-K	Rough Brass box only with cylinder key lock - hydrant extra	\$455.00	10.25
HY-9500-49-K	Chrome Plated Brass box only with cylinder key lock - hydrant extra	\$635.00	10.25

Add the List Price of the HY-9000-NPB wall faucet required to the List Price of the HY-9500 box to determine the total List Price for an encased HY-9000-NPB Series wall faucet.

To order an encased HY-9000-NPB Series wall faucet, specify the HY-9000-NPB MODEL # followed by the HY-9500 MODEL #. (e.g. HY-9241-NPB w/HY-9500). The HY-9000-NPB Series wall faucets with cast iron wheel handles are not intended for use with the HY-9500 box.

CALIFORNIA PROPOSITION 65 WARNING. This product contains chemicals known to the State of California to cause cancer and birth defects or other reproductive harm.

### HY-1500 WALL HYDRANT BOXES

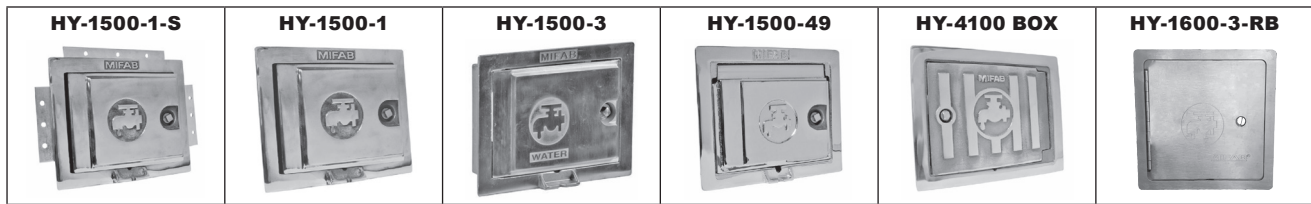

MIFAB's HY-1500 Series hydrant boxes feature a "drip lip" to drain water away from the wall to prevent unsightly staining. Standard with all of MIFAB's HY-1500-S hydrant boxes are four 1" x 1-1/4" slots on top and two sides of the box to receive the mounting brackets provided. Hardware is included to fasten the brackets to the box. The mounting brackets are designed to provide easy installation of the hydrant box onto the stud system for labor savings.

MODEL #	DESCRIPTION	LIST PRICE	WEIGHT LBS.
HY-1500-1	Satin Finish, Nickel Bronze Box	\$343.00	3.25
HY-1500-1-K	Satin Finish, Nickel Bronze Box with cylinder key lock	\$405.00	3.50
HY-1500-1-S	Satin Finish, Nickel Bronze Box With Slots, Mounting Brackets, Hardware	\$343.00	4.5
HY-1500-1-NL	Satin Finish, Nickel Bronze Box With no Drip Lip and Flush Cover for use with HY-6000-NPB Ground Hydrants	\$343.00	3.25
HY-1500-2	Polished Brass Plated, Nickel Bronze Box	\$462.00	3.25
HY-1500-2-S	Polished Brass Plated, Nickel Bronze Box With Slots, Mounting Brackets and Hardware	\$462.00	4.5
HY-1500-3	Satin Finish, Stainless Steel Box	\$343.00	3.25
HY-1500-3-NL	Satin Finish, Stainless Steel Box with no Drip Lip and Flush Cover for use with HY-6000-NPB Ground Hydrants	\$343.00	3.50
HY-1500-3-S	Satin Finish, Stainless Steel Box With Slots, Mounting Brackets, Hardware	\$343.00	4.5
HY-1500-49	Polished Chrome Plated, Nickel Bronze Box	\$343.00	3.25
HY-1500-49-S	Polished Chrome Plated, Nickel Bronze Box With Slots, Mounting Brackets and Hardware	\$343.00	4.5
HY-1600-3-RB	Satin Finish, Stainless Steel box with round back for 6" core hole for tilt up walls	\$343.00	4.00
HY-4100-1	Satin Finish, Nickel Bronze Box for HY-4000-NPB Hydrants	\$533.00	20
HY-4100-2	Polished Brass Plated, Nickel Bronze Box for HY-4000-NPB Hydrants	\$680.00	20
HY-4100-49	Polished Chrome Plated, Nickel Bronze Box for HY-4000-NPB Hydrants	\$533.00	20

### HYDRANT REPAIR KITS and ACCESSORIES

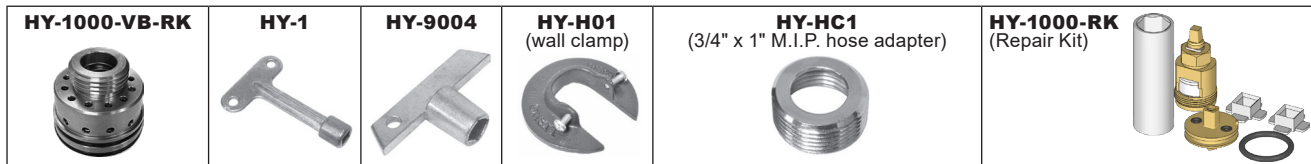

MODEL #	DESCRIPTION	LIST PRICE	WEIGHT LBS.
HY-1000-RK	Universal Repair Kit for HY-1000-NPB and HY-2000-NPB of Hydrants	\$95.00	2
HY-CIA-30/50	Repair Kit for HY-3000-NPB and HY-5000-NPB of Hydrants	\$80.00	1
HY-CIA-4000	Repair Kit for HY-4000-NPB of Hydrants	\$175.00	4
HY-H01	Wall Clamp for HY-1000-NPB, HY-2000-NPB, HY-4000-NPB, HY-4500-NPB Hydrants (Suffix -WC)	\$24.50	.50
HY-9001	Brown Plastic Wheel Handle only	\$24.50	.25
HY-9002	Clear Plastic Wheel Handle only	\$24.50	.25
HY-9003	Cast Iron Wheel Handle only	\$24.50	.25
HY-9004	Short Loose Tee Key (HY-9000) Breaker	\$24.50	.20
HY-1000-VB-RK	A.S.S.E. 1011 Approved Polished Chrome Plated Vacuum Breaker (HY-1000-NPB, 3000, 5000 and 6000) (Used to repair the vacuum breaker on the HY-1000 Series hydrants)	\$36.00	.25
HY-9005-B-NPB	A.S.S.E. 1011 Approved Rough Brass Vacuum Breaker. (3/4" hose connection. Use to add a rough brass vacuum breaker to a standard hose spigot that does not have a vacuum breaker)	\$24.50	.25
HY-9005-CP-NPB	A.S.S.E. 1011 Approved Polished Chrome Plated Vacuum Breaker. (3/4" hose connection. Use to add a polished chrome vacuum breaker to a standard hose spigot that does not have a vacuum breaker)	\$36.00	.25
HY-HC1	1" M.I.P. Hose Connection Adapter (to convert a 3/4" M.I.P. Hose) connection to a 1" M.I.P. hose connection. (Suffix -HC1)	\$39.00	.25

MODEL #	DESCRIPTION	LIST PRICE
HY-9000-VB	A.S.S.E. 1011 Approved Rough Brass Vacuum Breaker (to replace vacuum breaker on the HY-9040-NPB or HY-9041-NPB)	\$24.50
HY-9000-VB-49	A.S.S.E. 1011 Approved Polished Chrome Plated Vacuum Breaker (to replace vacuum breaker on the HY-9240-NPB or HY-9241-NPB)	\$24.50

SUFFIX	DESCRIPTION	LIST PRICE
HY-1	Long loose operating tee key	\$22.00
-K	Cylinder Key Lock	\$63.00
-S	Slots in Hydrant Box, with Brackets and Mounting Hardware	No Add



*"We have sold the MIFAB hydrants and boxes. To date, no complaints or concerns. No news is always good news. They work well."* – Doug Murphy, Eddy Group, Halifax, Nova Scotia

CALIFORNIA PROPOSITION 65 WARNING. This product contains chemicals known to the State of California to cause cancer and birth defects or other reproductive harm.

Design and dimensions are subject to modification. Prices do not include applicable taxes.

Visit [www.mifab.com](http://www.mifab.com) for the most recent product information.

MIFAB<sup>®</sup>, Inc., 1321 West 119th Street, Chicago, Illinois 60643-5109, USA

Toll Free: 1-800-465-2736, Fax: 1-773-341-3049

All sales subject to MIFAB's<sup>®</sup> Terms and Warranties. Please refer to page 3.

sales@mifab.com Canada Toll Free: 1-800-387-3880

**MI-TR PVC SOCKET TRANSITION COUPLING**

Ideal for below ground to above ground PVC pipe connections. The bottom of the MI-TR has either a 2", 3", or 4" PVC socket connection and the inside of the top of the MI-TR also has either a 2", 3", or 4" PVC socket connection. The MI-TR is placed over the PVC pipe. The included orange cover will seal the top. An identifying whisker sticking up from the top of the orange cap provides location identification after the concrete pour covers the orange cover. Channel lock grips in the top of the orange cover (protected by a sticker) provide a means for the contractor to use channel locks to remove the cover after the concrete poured over the cover is removed. Once the orange cover is removed, one can socket weld a PVC pipe through the top of the MI-TR to complete the under ground PVC pipe to above ground PVC pipe connection.

MODEL #	A	SOCKET DEPTH (B1)	SOCKET DEPTH (B2)	PIPE OD (C1)	PIPE OD (C2)	LIST PRICE
MI-TR-2	3-9/16"	1-3/16"	1-3/16"	2" SCH. 40 PVC	2" SCH. 40 PVC	\$66.00
MI-TR-3	5"	1-7/8"	1-7/8"	3" SCH. 40 PVC	3" SCH. 40 PVC	\$66.00
MI-TR-4	5 1/4"	2"	2"	4" SCH. 40 PVC	4" SCH. 40 PVC	\$66.00

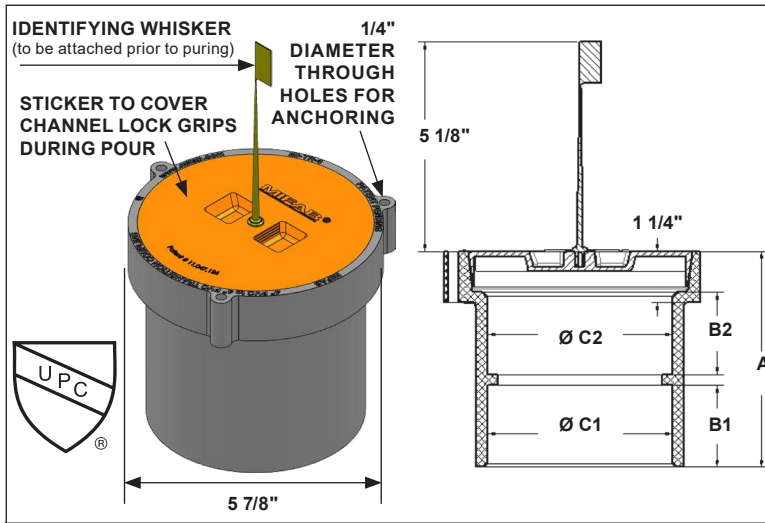

**1. POUR CONCRETE**

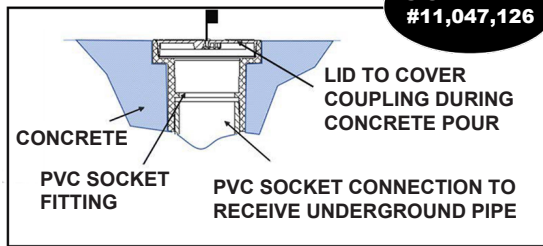

**2. REMOVE AND ATTACH THE UPPER PIPE**

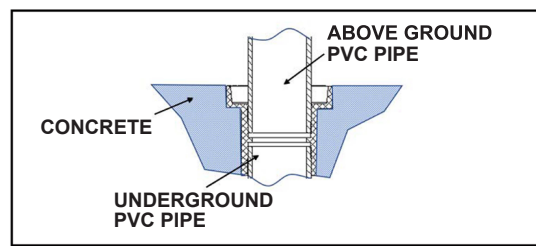

WITHOUT MI-TR MINIMUM DIM IS...

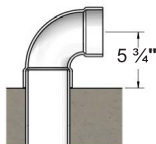

MEDIUM SWEEP STREET 90 FITTING

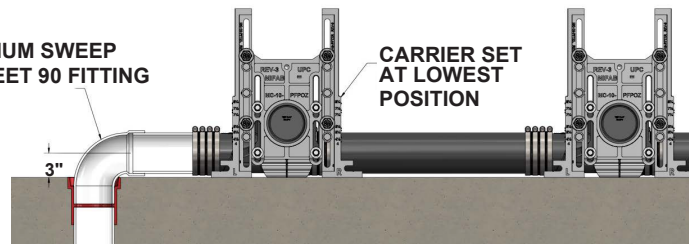

The MI-TR can also be used to receive a medium sweep street 90 fitting from the horizontal waste line from an off the floor water closet carrier fitting. The MI-TR will be installed in the ground, flush to grade, over PVC drain pipe. This allows one or two more water closet carriers to be installed and still have enough vertical space to connect the horizontal carrier fitting waste line with a medium sweep street 90 fitting to the MI-TR transition coupling.

CALIFORNIA PROPOSITION 65 WARNING. This product contains chemicals known to the State of California to cause cancer and birth defects or other reproductive harm.



**POLYETHYLENE ROOFGUARD**
**MAKE ROOF DRAINS UNCLOGGABLE**
**APPLICATIONS:**

\* Ideal to replace existing roof drain domes on the roofs of schools, warehouses, factories, office buildings and any other building that has standing water on the roof due to clogged roof drain domes.

**RoofGuard ELIMINATES STANDING WATER:**

- Patented design increases surface area by up to 5x or more making a RoofGuard protected drain virtually uncloggable. RoofGuard SAVES \$\$
- RoofGuard works 24/7.
- Eliminates leaks and costly repairs caused by clogged drains.
- RoofGuard will replace any Roof Drain Dome Strainer up to 15" in diameter.
- Installation is fast, simple, and requires no tools.
- Removable Top allows easy access to drain and piping without detaching RoofGuard.

**INSTRUCTIONS:**

- Clean and remove all dirt, debris, and other loose material in area around the drain where RoofGuard is to be installed. After cleaning, if the area is wet dry it off removing as much moisture as possible.
- Remove and dispose of current drain dome strainer.
- Turn RoofGuard over and fill the Attachment Pods with an exterior adhesive such as Chemlink M-1 or equal. Make sure the Pods are completely full and overflowing with adhesive to properly bond.
- Turn RoofGuard over to install over the drain. Press firmly on top of the Attachment Pods to ensure good adhesion to the roof surface.

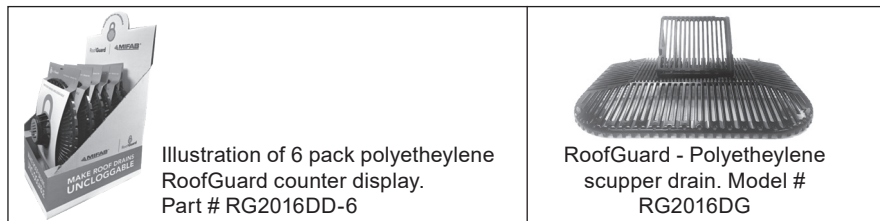
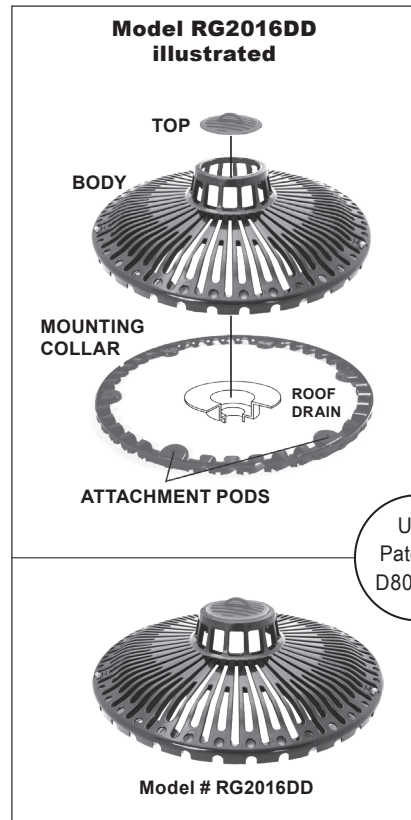
**CAST IRON ROOFGUARD**

In applications where a cast iron RoofGuard is preferred, MIFAB's model number RG2016DDC cast iron RoofGuard is ideal.

**APPLICATIONS:**

\*Ideal to replace existing roof drain domes on the roofs of schools, warehouses, factories, office buildings and any other building that has standing water on the roof due to clogged roof drain domes. The cast iron RoofGuard ensures a long life. It is also positively bolted to the roof drain body and membrane clamp.

**INSTRUCTIONS:**

- The RoofGuard will retrofit onto any existing roof drain (MIFAB, Zurn, JR Smith, Wade, Josam or Watts body).
- Remove the existing roof drain dome. Remove the bolts from the membrane clamp ring one at a time and replace them with the provided hardware (MIFAB HS-19).
- Assemble the threaded rods into the body. Add the washer and nut onto the threaded rod, securing the membrane clamp ring to the body. Add another nut and washer to the threaded rod, one inch above the membrane clamp ring (adjusting nut).
- Repeat this process until all bolts on the membrane clamp ring have been removed and replaced.
- Place the RoofGuard over the drain body.
- Add a washer and nut to the top of all of the threaded rods in order to secure the dome. Cut the excess thread off of the threaded rods.

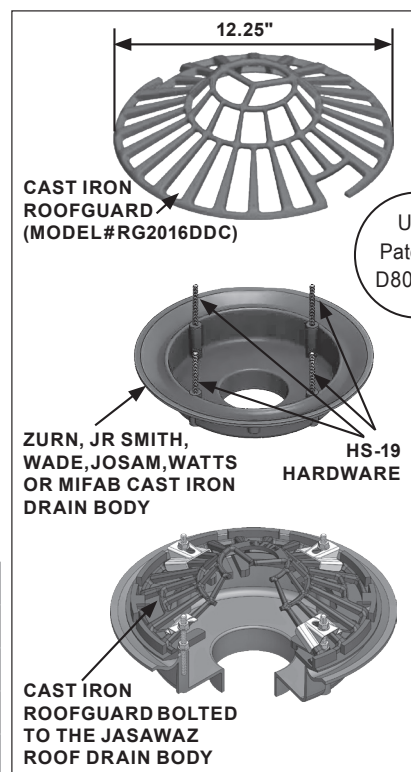

MODEL #	DESCRIPTION	LIST PRICE
RG2016DD	Polyethylene RoofGuard	\$116.00
RG2016DD-6	Polyethylene RoofGuard, 6 pack	\$696.00
RG2016DDC	Cast Iron RoofGuard	\$147.00
RG2016DG	Polyethylene Scupper RoofGuard	\$126.00

CALIFORNIA PROPOSITION 65 WARNING. This product contains chemicals known to the State of California to cause cancer and birth defects or other reproductive harm.

Design and dimensions are subject to modification. Prices do not include applicable taxes.

Visit [www.mifab.com](http://www.mifab.com) for the most recent product information.

MIFAB®, Inc., 1321 West 119th Street, Chicago, Illinois 60643-5109, USA

Toll Free: 1-800-465-2736, Fax: 1-773-341-3049

All sales subject to MIFAB's® Terms and Warranties. Please refer to page 3.

sales@mifab.com Canada Toll Free: 1-800-387-3880

## SYNTHETIC DIAMOND GRIP NITRILE DISPOSABLE GLOVES

**Specification:** MIFAB® synthetic, nitrile, exam grade, disposable gloves with diamond grip for durability and dexterity.

**Function:** Ideal for plumbing, janitorial, painting and / or automotive. Powder free and chemical resistant. Non latex.

### DIAMOND GRIP ENHANCES GRIPPING POWER.



Meets  
ASTM D6978  
to handle  
Fentanyl  
substances



POWDER-FREE



EXAM GRADE



LATEX-FREE



TEXTURED GRIP



SINGLE USE ONLY

MODEL #	SIZE	QTY (by weight)	List Price
MI-GLV-M	Medium	100 (1 box)	\$20.00
MI-GLV-L	Large	100 (1 box)	\$20.00
MI-GLV-XL	Extra Large	100 (1 box)	\$20.00
CASE QUANTITY			
MI-GLV-M-C	Medium	1000 (1 case, 10 boxes)	\$200.00
MI-GLV-L-C	Large	1000 (1 case, 10 boxes)	\$200.00
MI-GLV-XL-C	Extra Large	1000 (1 case, 10 boxes)	\$200.00

POWDER FREE	
FACTS & FEATURES	Diamond texture design
	Strong toughness
	Fits hand curve
	Provides good identification

GLOVE ATTRIBUTES	
DESIGN	Ambidextrous, Non sterile, Beaded cuff
COLOUR	Black
SIZE	M, L, XL

DIAMOND GRIP NITRILE GLOVES		
LENGTH (mm)		Minimum 230 mm
THICKNESS (mm)	Cuff (mm)	Minimum 0.06mm
	Palm (mm)	Minimum 0.16 mm
	Finger (mm)	Minimum 0.16 mm
TENSILE STRENGTH (MPA)	Before aging	Minimum 15MPa
	After aging	Minimum 14MPa
ELONGATION(%)	Before aging	Minimum 500%
	After aging	Minimum 400%
WIDTH (+/- 10 mm)	M	95 mm
	L	110 mm
	XL	120 mm
WEIGHT (+/- 0.3 g)	Medium	6.5 g
	Large	7.0 g
	X-Large	7.5 g

STORAGE
Keep out of direct sunlight; store in a cool & dry place.

CALIFORNIA PROPOSITION 65 WARNING. This product contains chemicals known to the State of California to cause cancer and birth defects or other reproductive harm.

**ALLSTAR® COVER**

*"I think the All Star covers are a great idea. For customers that use a lot of MIFAB drains it offers great benefits and is worth the investment."*

– Lorenzo Tripodi, Principal, Noraqua, Sudbury, Ontario, Canada

MIFAB's new, patent pending Allstar® cover is available in 5" and 6" round sizes to work with any of MIFAB's 5" and 6" round floor drain and cleanout tops.

It is manufactured from recycled plastic and is designed to fit into any of MIFAB's A1 and A4 PVC, ABS or cast iron bodies.

Contractors fit the Allstar cover into the top of the MIFAB drain body before the concrete pour, install the bodies onto the pipe and advise the concrete contractors to measure the level of the concrete floor from the top of the Allstar cover.

After the concrete pour around the top of the Allstar cover, the Allstar cover is removed with a tool placed into the recessed slot in the middle of the cover and pried off.

The 4" NPSM threads machined into the top of all of MIFAB's A1 and A4 bodies are then exposed to allow the contractor to thread in any MIFAB 5" (use the 5" Allstar cover) or 6" (use the 6" Allstar cover) round floor drain and cleanout top into the top of the bodies. The tops can be adjusted to the finished floor.

There is only a 1/8" space around the outside diameter of the floor drain or cleanout top to finish off with grout.

The Allstar cover is approximately 3/4" high and is made from smooth plastic material with angled sides to ensure removal after the pour.

There are several advantages to the Allstar cover:

- 1) The contractor can avoid taping the floor drain and cleanout tops prior to installation to ensure that they are protected during the construction process. This eliminates time to tape the floor drain / cleanout tops and also eliminates cleaning time to remove the tape from them before the project is handed over to the client.
- 2) The contractor can avoid installing the floor drain and cleanout tops until the end of the project – reducing the risk that they will be stolen or damaged.
- 3) The floor drain / cleanout tops can be adjusted to the finished floor after the concrete pour.
- 4) The Allstar cover can be purchased separately from the floor drain and cleanout bodies.
- 5) The Allstar cover can be used over and over again.

MODEL #	LIST PRICE
<b>A1-5-ALLSTAR</b>	<b>\$30.00</b>
<b>A1-6-ALLSTAR</b>	<b>\$33.00</b>



Allstar cover with any MIFAB A1 body

Allstar cover with any MIFAB A4 body

CALIFORNIA PROPOSITION 65 WARNING. This product contains chemicals known to the State of California to cause cancer and birth defects or other reproductive harm.

Design and dimensions are subject to modification. Prices do not include applicable taxes. Visit [www.mifab.com](http://www.mifab.com) for the most recent product information.

MIFAB®, Inc., 1321 West 119th Street, Chicago, Illinois 60643-5109, USA  
All sales subject to MIFAB's® Terms and Warranties. Please refer to page 3.

Toll Free: 1-800-465-2736, Fax: 1-773-341-3049  
sales@mifab.com Canada Toll Free: 1-800-387-3880

**THE MIFAB MODULAR SYSTEM**



**FLOOR DRAIN**

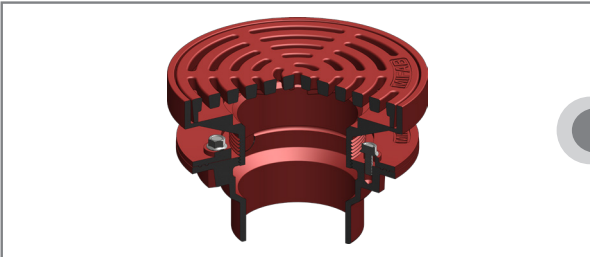

**AREA DRAIN**

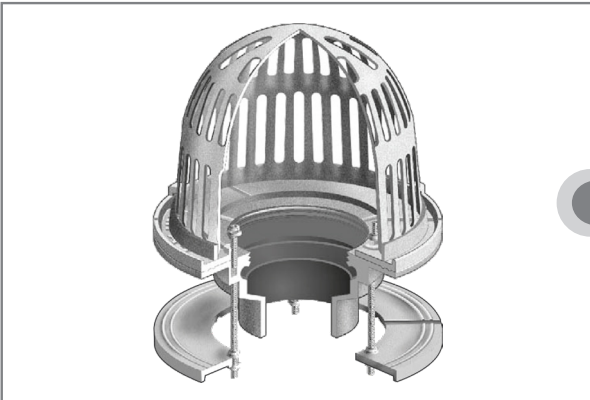

**ROOF DRAIN**

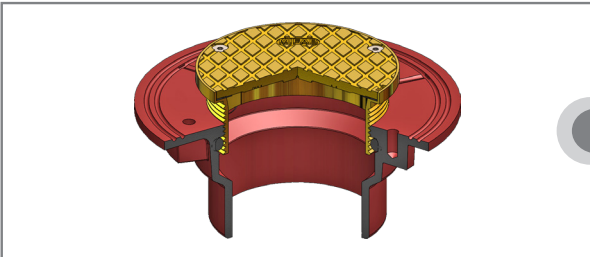

**CLEANOUT**

**DYNAC**  
(DO YOU NEED A CLAMP?)

In 90% of today's "slab on grade" installations, there is no need for a membrane clamp, as there is no waterproofing membrane installed. Because MIFAB's unique design allows the strainer assembly to install directly into the throat of the drain body, the use of a membrane clamping collar is optional.

- This is an opportunity for cost savings.
- Why use a drain with a membrane clamp if it is not necessary?

**THE MIFAB® MODULAR SYSTEM**

*"Using the MIFAB AllStar covers makes our drain installs clean, fast and easy. It saves time, and for the plumber, that means cost. Well worth the investment."*  
 – Samuel Beliveau, V/P Plomberie, Groupe CEVEC, Drummondville Québec

CALIFORNIA PROPOSITION 65 WARNING. This product contains chemicals known to the State of California to cause cancer and birth defects or other reproductive harm.

**CASE STUDY**

**MIFAB HY-1000 Series Wall Hydrants installed in New York City**



**MIFAB product installed:**  
HY-1008-NPB, Non-Freeze Wall Hydrant

**Contractor:** Parkview Plumbing

**Job location:** New York City

**MIFAB Sales Agent:** DEA Sales

**Location:** 150 Charles Street, NYC

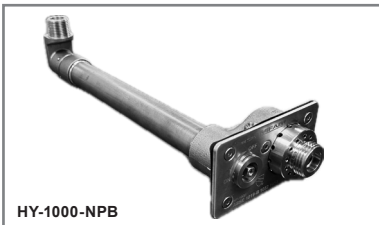

*"One of the most important feature we need is MIFAB's unique 360 degree swivel wall hydrant design. This allows our team for the easiest installation from limited space on the building."*  
 – Parkview Plumbing, Jay Lyons, Owner

CALIFORNIA PROPOSITION 65 WARNING. This product contains chemicals known to the State of California to cause cancer and birth defects or other reproductive harm.

Design and dimensions are subject to modification. Prices do not include applicable taxes. Visit [www.mifab.com](http://www.mifab.com) for the most recent product information.

MIFAB®, Inc., 1321 West 119th Street, Chicago, Illinois 60643-5109, USA  
 All sales subject to MIFAB's® Terms and Warranties. Please refer to page 3.

Toll Free: 1-800-465-2736, Fax: 1-773-341-3049  
[sales@mifab.com](mailto:sales@mifab.com) Canada Toll Free: 1-800-387-3880

**PRODUCT FEATURE**

**MIFAB's 3 in 1 Floor Sink PVC grate assembly**

**MIFAB Product Purchased –**  
FS520 and FS720 Series PVC Floor Sinks

**Wholesaler -** Midsouth Plumbing and Electric Supply

**Location –** Jonesboro, AR

**MIFAB Sales Agent –** Blackjack Mountain Marketing

**MIFAB Patent # -** 9,458,616



*"The new three in one grate for the PVC floor sinks have allowed us as a wholesale company to lower the amount of sku's that we have to keep in stock. Before we had to keep a full grate, a ¾ grate and a ½ grate to be able to supply the customers with whatever configuration would be required for each job. Now one grate does it all. This benefits the plumbing contractor as well by always having the correct grate as required. They can now wait until the end of the job to make whatever configuration is needed. As we all know, jobs are constantly changing and this allows us to never have the wrong grate installed. This also brings a certain amount of safety to the job site. By keeping the floor sink covered with a full grate the possibility of someone stepping into the ½ open portion is taken out of the equation.*

*I hope this helps and serves as our testimonial to the strengths of the three in one grate design from a wholesaler's point of view and some insight I've received from plumbers."*

*– Ronald Wheelless, Midsouth Plumbing and Electric Supply, Jonesboro, AR*

CALIFORNIA PROPOSITION 65 WARNING. This product contains chemicals known to the State of California to cause cancer and birth defects or other reproductive harm.

## CROSS REFERENCE

### FRANK PATTERN TO MIFAB®

#### FLOOR DRAINS

<b>Frank P</b> .....	<b>MIFAB</b>
72.....(pg.9).....	F102P
C-72.....(pg.9).....	F102X
N-72.....(pg.9).....	F102
T-72.....(pg.9).....	F102T
N-73.....(pg.9).....	F103
T-73.....(pg.9).....	F103T
N-74.....(pg.9).....	F104
w/4375R.....(pg.13).....	5-1-CL
w/5375R.....(pg.13).....	5-1-CL
w/5375S.....(pg.13).....	S5-1-CL
w/6375R.....(pg.13).....	6-1-CL
w/6375S.....(pg.13).....	S6-1-CL
w/7375R.....(pg.13).....	7-1-CL
w/8375R.....(pg.13).....	8-1-CL
N-702.....(pg.10).....	F102-C
T-702.....(pg.10).....	F102T-C
N-703.....(pg.10).....	F103-C
T-703.....(pg.10).....	F103T-C
N-704.....(pg.10).....	F104-C
w/4375R.....(pg.13).....	5-1-CL
w/5375R.....(pg.13).....	5-1-CL
w/5375S.....(pg.13).....	S5-1-CL
w/6375R.....(pg.13).....	6-1-CL
w/6375S.....(pg.13).....	S6-1-CL
w/7375R.....(pg.13).....	7-1-CL
w/8375R.....(pg.13).....	8-1-CL
N-902.....(pg.10).....	F102-C
T-902.....(pg.10).....	F102T-C
N-903.....(pg.10).....	F103-C
T-903.....(pg.10).....	F103T-C
N-904.....(pg.10).....	F104-C
T-904.....(pg.10).....	F104T-C
w/4375R.....(pg.13).....	5-1-CL
w/5375R.....(pg.13).....	5-1-CL
w/5375S.....(pg.13).....	S5-1-CL
w/6375R.....(pg.13).....	6-1-CL
w/6375S.....(pg.13).....	S6-1-CL
w/7375R.....(pg.13).....	7-1-CL
w/8375R.....(pg.13).....	8-1-CL
4375R.....(pg.13).....	5-1-CL
5375R.....(pg.13).....	5-1-CL
5375S.....(pg.13).....	S5-1-CL
6375R.....(pg.13).....	6-1-CL
6375S.....(pg.13).....	S6-1-CL
7020.....(pg.9).....	F102P
7030.....(pg.9).....	F103P
7375R.....(pg.13).....	7-1-CL
8375R.....(pg.13).....	8-1-CL
9020.....(pg.10).....	F102P-C
9030.....(pg.10).....	F102P-C

9040.....(pg.10).....	F102P-C
w/4375R.....(pg.13).....	5-1-CL
w/5375R.....(pg.13).....	5-1-CL
w/5375S.....(pg.13).....	S5-1-CL
w/6375R.....(pg.13).....	6-1-CL
w/6375S.....(pg.13).....	S6-1-CL
w/7375R.....(pg.13).....	7-1-CL
w/8375R.....(pg.13).....	8-1-CL

#### FLOOR DRAIN OPTIONS

<b>Frank P</b> .....	<b>MIFAB</b>
100-EX.....(pg.16).....	DD-50-CL
F-4R.....(pg.16).....	F4-50-CL
F-6R.....(pg.16).....	F6-50-CL
F-90.....(pg.16).....	G-50-CL

#### CESSPOOL DRAINS

<b>Frank P</b> .....	<b>MIFAB</b>
20C.....(pg.11).....	F302P
30C.....(pg.11).....	F303P
40C.....(pg.11).....	F324P

#### DECK DRAINS

<b>Frank P</b> .....	<b>MIFAB</b>
6520N.....(pg.16).....	F652
6520T.....(pg.16).....	F652T
6530N.....(pg.16).....	F653
6530T.....(pg.16).....	F653T
6540N.....(pg.16).....	F654

#### CLEANOUTS & ACCESS COVERS

<b>Frank P</b> .....	<b>MIFAB</b>
6S-1.....(pg.16).....	SW6-4
6S-B.....(pg.16).....	SW6-1
6SP-1.....(pg.16).....	SW6P-4
6SP-B.....(pg.16).....	SW6P-1
N402.....(pg.13).....	A1-2NH-7-CL
N402-4430.....(pg.12).....	C222-R
N403.....(pg.13).....	A1-3NH-7-CL
N403-4430.....(pg.12).....	C223-R
N404.....(pg.13).....	A1-4NH-7-CL
N404-4440.....(pg.12).....	C224-R
2340.....(pg.17).....	C236-TS-4
4020.....(pg.13).....	A1-2P-7-CL
4020 w/4430.....(pg.12).....	C222P-R
4030.....(pg.13).....	A1-3P-7-CL
4030 w/4430.....(pg.12).....	C223P-R
4040.....(pg.13).....	A1-4P-7-CL
4040 w/4440.....(pg.12).....	C224P-R
4430.....(pg.17).....	C234-TS-1
4440.....(pg.17).....	C236-TS-1
4630.....(pg.17).....	C300-R6-1
4640.....(pg.17).....	C300-R6-1
4730.....(pg.17).....	C300-R6-NL-1
4740.....(pg.17).....	C300-R6-NL-1

#### CLOSET FLANGES

<b>Frank P</b> .....	<b>MIFAB</b>
30.....(pg.18).....	CF32
40.....(pg.18).....	CF42
OS40.....(pg.18).....	CFOS42
40TC.....(pg.18).....	CF42TC
44.....(pg.18).....	CF44D
46.....(pg.18).....	CF46D

#### ROOF DRAINS

<b>Frank P</b> .....	<b>MIFAB</b>
OF-2.....(pg.17).....	R102-OF
OF-3.....(pg.17).....	R103-OF
OF-4.....(pg.17).....	R104-OF
850-2N.....(pg.17).....	R152
850-3N.....(pg.17).....	R153
850-4N.....(pg.17).....	R154
852.....(pg.17).....	R102P
852N.....(pg.17).....	R102
852SN.....(pg.17).....	R102N-90
852ST.....(pg.17).....	R102-90
852T.....(pg.17).....	R102T
853.....(pg.17).....	R103P
853N.....(pg.17).....	R103
853SN.....(pg.17).....	R103N-90
853ST.....(pg.17).....	R103-90
853T.....(pg.17).....	R103T
854.....(pg.17).....	R104P
854N.....(pg.17).....	R104
854SN.....(pg.17).....	R104N-90
854T.....(pg.17).....	R104T
856N.....(pg.17).....	R106
1202N.....(pg.17).....	R202
1203N.....(pg.17).....	R203
1204N.....(pg.17).....	R204

#### SHOWER DRAINS

<b>Frank P</b> .....	<b>MIFAB</b>
20SD.....(pg.16).....	50-SD-TC
21SD.....(pg.16).....	50-SD-TC
220NC.....(pg.16).....	50-SD-TC
T-6.....(pg.16).....	50-SD-T

#### IPS TO MIFAB®

<b>IPS</b> .....	<b>MIFAB</b>
82770.....(see MPB book).....	C1430
82785.....(see MPB book).....	C1430
82787.....(see MPB book).....	C1430
82790.....(see MPB book).....	C1430
85815.....(pg.15).....	FD230
85820.....(pg.15).....	FD230
85825.....(pg.15).....	FD230
85830.....(pg.15).....	FD230
85840.....(pg.15).....	FD230
85855.....(pg.15).....	FD230

85860.....(pg.15).....	FD230
85865.....(see MPB book).....	C1230
85870.....(see MPB book).....	C1230
85875.....(see MPB book).....	C1230
85880.....(see MPB book).....	C1230
85895.....(pg.8).....	F220
85900.....(pg.8).....	F220
85905.....(pg.12).....	C220-R
85910.....(pg.12).....	C220-R
85915.....(see MPB book).....	C1230
85925.....(see MPB book).....	C1230
85975.....(pg.14).....	FD212TC-49
85976.....(pg.14).....	FD212TC-49
85980.....(pg.14).....	FD212TC-49
85981.....(pg.14).....	FD212TC-49
85984.....(pg.14).....	FD212TC-49
85985.....(pg.14).....	FD212TC-49
85990.....(pg.14).....	FD212TC-49
85995.....(pg.14).....	FD212TC-49
86075.....(pg.14).....	SD7000
86077.....(pg.14).....	SD7000
86078.....(pg.14).....	SD7000
86079.....(pg.14).....	SD7000
86080.....(pg.14).....	SD7000
86081.....(pg.14).....	SD7000
86095.....(pg.17).....	R100-30
86100.....(pg.17).....	R100-31
86105.....(pg.17).....	R100-30
86110.....(pg.17).....	R100-31
86125.....(pg.17).....	R100-30 / 31
89403.....(pg.10).....	F100-C
89405.....(pg.10).....	F100-C
89406.....(pg.10).....	F100-C
89419.....(pg.10).....	F100-C
89420.....(pg.10).....	F100-C
89421.....(pg.10).....	F100-C
89422.....(pg.10).....	F100-C
89427.....(pg.10).....	F100-C
89428.....(pg.10).....	F100-C
89549.....(pg.10).....	F100-C
89551.....(pg.10).....	F100-C
89552.....(pg.10).....	F100-C
89564.....(pg.10).....	F100-C
89565.....(pg.10).....	F100-C
89566.....(pg.10).....	F100-C
89567.....(pg.10).....	F100-C
89568.....(pg.10).....	F100-C
89569.....(pg.10).....	F100-C

### JONES STEPHENS TO MIFAB®

#### CLEANOUTS

<b>J Stephens</b> .....	<b>MIFAB</b>
A4 Series.....(pg.12).....	C220-R

CALIFORNIA PROPOSITION 65 WARNING. This product contains chemicals known to the State of California to cause cancer and birth defects or other reproductive harm.

Design and dimensions are subject to modification. Prices do not include applicable taxes.

Visit [www.mifab.com](http://www.mifab.com) for the most recent product information.

MIFAB®, Inc., 1321 West 119th Street, Chicago, Illinois 60643-5109, USA

Toll Free: 1-800-465-2736, Fax: 1-773-341-3049

All sales subject to MIFAB's® Terms and Warranties. Please refer to page 3.

sales@mifab.com Canada Toll Free: 1-800-387-3880

C33 Series ... (pg.17) ... C234-TS-1 / C236-TS-1  
 C36 Series..... (see MPB book) ..... C1230  
 C59 Series..... (pg.12) ..... C220-R  
 C60 Series..... (see MPB book) ..... C1230  
 C61 Series..... (pg.12) ..... C220-R  
 P49 Series..... (see MPB book) ..... C1430

### CLOSET FLANGES

**J Stephens** ..... **MIFAB**  
 C40320 ..... (pg.18) ..... CF32  
 C40420 ..... (pg.18) ..... CF42  
 C40425 ..... (pg.18) ..... CF42TC  
 C40440 ..... (pg.18) ..... CF44DTC  
 C40500 ..... (pg.18) ..... CF42TC  
 C40640 ..... (pg.18) ..... CFOS42TC

### FLOOR DRAINS

**J Stephens** ..... **MIFAB**  
 D41 Series..... (pg.14) ..... SD7000  
 D50 Series..... (pg.14) ..... FD212TC-49  
 D51 Series..... (pg.10) ..... F100-C  
 D52 Series..... (pg.8) ..... F220  
 D53 Series..... (pg.8) ..... F220  
 D54 Series..... (pg.15) ..... FD230  
 D56 Series..... (pg.8) ..... F220  
 D59 Series..... (pg.10) ..... F100-C  
 D60 Series..... (pg.10) ..... F100-C  
 D64 Series..... (pg.16) ..... 50-SD-TC  
 D65 Series..... (pg.10) ..... F100-C  
 D66 Series..... (pg.10) ..... F100-C  
 D67 Series..... (pg.9) ..... F100  
 D80 Series..... (pg.10) ..... F100-C  
 J60 Series..... (see MPB book) ..... F1120

### FLOOR SINKS (Porcelain, Cast Iron)

**J Stephens** ..... **MIFAB**  
 S55112 ..... (pg.21) ..... FS722-PB  
 S55113 ..... (pg.21) ..... FS722-PB  
 S55114 ..... (pg.21) ..... FS724-PB  
 S55075 ..... (pg.21) ..... FS700-PG-175  
 S55050 ..... (pg.21) ..... FS700-PG-150  
 S55010 ..... (pg.21) ..... FS700-PG

### FLOOR SINKS (PVC)

Jones Stephens..... **MIFAB**  
 S59004 ..... (pg.20) ..... FS724-PB-30  
 S59003 ..... (pg.20) ..... FS723-PB-30  
 S59002 ..... (pg.20) ..... FS722-PB-30  
 S59012 ..... (pg.20) ..... FS700-PG-150-30  
 S59011 ..... (pg.20) ..... FS700-PG-175-30  
 S59010 ..... (pg.20) ..... FS700-PG-30  
 S59094 ..... (pg.20) ..... FS724-30

### CAST IRON SEWER COVERS

**J Stephens**..... **MIFAB**  
 S36008..... (pg.18) ..... MI-SCOV-8  
 S36010..... (pg.18) ..... MI-SCOV-10

### ROOF DRAINS

**Jones Stephens** ..... **MIFAB**  
 R18 Series..... (pg.17) ..... R100-30 / 31  
 R19 Series..... (pg.17) ..... R100

### OATEY TO MIFAB®

**Oatey**..... **MIFAB**  
 42201..... (pg.16) ..... 50-SD-TC  
 42206..... (pg.16) ..... 50-SD-TC  
 42210..... (pg.14) ..... FD212TC-49  
 42213..... (pg.14) ..... FD212TC-49  
 42218..... (pg.14) ..... FD212TC-49  
 42219..... (pg.14) ..... FD212TC-49  
 42253..... (pg.18) ..... CF42  
 42255..... (pg.18) ..... CF42  
 42256..... (pg.18) ..... CF42TC  
 42369..... (see MPB book) ..... C1430  
 42370..... (see MPB book) ..... C1430  
 42371..... (see MPB book) ..... C1430  
 42372..... (see MPB book) ..... C1430  
 42373..... (see MPB book) ..... C1430  
 42374..... (see MPB book) ..... C1430  
 42399..... (pg.14) ..... FD212TC-49  
 42404..... (pg.14) ..... FD212TC-49  
 43578..... (pg.15) ..... FD230  
 43579..... (pg.15) ..... FD230  
 43580..... (pg.15) ..... FD230  
 43581..... (pg.15) ..... FD230  
 43582..... (pg.15) ..... FD230  
 43583..... (pg.15) ..... FD230  
 43598..... (pg.15) ..... FD230  
 43599..... (pg.15) ..... FD230  
 43600..... (pg.15) ..... FD230  
 43601..... (pg.15) ..... FD230  
 43711..... (see MPB book) ..... C1230  
 43731..... (see MPB book) ..... C1230  
 43733..... (see MPB book) ..... C1230  
 43736..... (pg.12) ..... C220-R  
 43737..... (pg.12) ..... C220-R

### PLASTIC ODDITIES TO MIFAB®

**Plastic Oddities**..... **MIFAB**  
 AAB Series..... (pg.8) ..... F220-31  
 ABR Series..... (pg.10) ..... F100-31-C  
 ACA-4 ..... (see MPB book) ..... C1230  
 ACO Series..... (pg.12) ..... C220-R-31  
 AFG Series..... (pg.14) ..... SD7000  
 AGA Series..... (pg.14) ..... SD7000 / F220-31  
 AGI Series..... (see MPB book) ..... C1230  
 AGP Series..... (pg.15) ..... FD230  
 AGR-391s..... (pg.15) ..... FD230  
 AHD-800 Series..... (pg.10) ..... F100-31-C  
 ALP Series..... (pg.14) ..... SD7000  
 ARD Series..... (pg.17) ..... R100-31  
 ARP Series..... (see MPB book) ..... C1430  
 ASB Series..... (see MPB book) ..... F340

ASC Series..... (see MPB book) ..... C1230  
 ASD Series..... (see MPB book) ..... F340  
 AWC Series..... (pg.17) ..... R100  
 AWF Series..... (pg.17) ..... R100  
 BRH Series..... (see MPB book) ..... C1430  
 BRP Series..... (see MPB book) ..... C1430  
 PAB Series..... (pg.8) ..... F220  
 PBR Series..... (pg.10) ..... F100-C /  
 ..... (pg.14) ..... FD212TC-49  
 PCA Series..... (see MPB book) ..... C1230  
 PCO Series..... (pg.12) ..... C220-R  
 PFG Series..... (pg.14) ..... SD7000  
 PGA Series..... (pg.14) ..... SD7000  
 PGI Series..... (see MPB book) ..... C1230  
 PGP Series..... (pg.15) ..... FD230  
 PHD Series..... (pg.10) ..... F100-C-30  
 PLP Series..... (pg.10) ..... F100-C  
 PRD Series..... (pg.17) ..... R100-30 / 31  
 PRP Series..... (see MPB book) ..... C1430  
 PSB Series..... (see MPB book) ..... F340  
 PSC Series..... (see MPB book) ..... C1230  
 PSD Series..... (see MPB book) ..... F340  
 PSI Series..... (pg.8) ..... F220  
 PWC Series..... (pg.17) ..... R100-30 / 31  
 PWF Series..... (pg.17) ..... R100-30 / 31  
 UDC Series..... (pg.17) ..... R100-30 / 31

### SHIUX CHIEF TO MIFAB®

#### FLOOR DRAINS, ROOF DRAINS & CLEANOUTS

**Shiux Chief**..... **MIFAB**  
 820 Series..... (pg.10) ..... F100-C  
 821 Series..... (pg.14) ..... SD7000  
 822 (Halo)..... (pg.6) ..... F220-TS-WF  
 822 Series..... (pg.7) ..... C220-TOS-WF  
 824 Series..... (pg.14) ..... SD7000  
 825 Series..... (pg.14) ..... SD7000  
 832 Series..... (pg.4) ..... F220-TS  
 833 Series..... (pg.10,11) ..... F100-C, F300  
 834 Series..... (pg.7) ..... C220-TOS  
 840 Series..... (pg.15) ..... FD230  
 842 Series..... (pg.4) ..... F220-TS-30/31  
 843 Series..... (pg.8) ..... F220  
 844 Series..... (pg.8) ..... F220  
 847 Series..... (pg.16) ..... FD-960  
 850 Series..... (pg.17) ..... C230-TS  
 851 Series..... (pg.17) ..... C230-TS  
 852 Series..... (pg.12) ..... C220-R  
 858 Series..... (pg.12) ..... C220-R  
 860 Series..... (pg.11) ..... F320  
 863 Series..... (pg.10) ..... F100-C  
 864 Series..... (pg.11) ..... F300  
 867 Series..... (pg.17) ..... R100-30 / 31  
 868 Series..... (pg.17) ..... R200  
 870 Series..... (see MPB book) ..... C1400-RD  
 873 Series..... (see MPB book) ..... C1430-RD  
 876 Series..... (see MPB book) ..... C1430

877 Series..... (see MPB book) ..... C1430  
 878 Series..... (see MPB book) ..... C1430  
 890 Series..... (pg.18) ..... CF42TC

### FLOOR SINKS (PVC)

**Shiux Chief**..... **MIFAB**  
 861 Series..... (pg.20) ..... FS720-30

### FLOOR SINKS (CAST IRON)

**Shiux Chief**..... **MIFAB**  
 860 Series..... (see MPB book) ..... FS1750  
 861-23 Series..... (pg.21) ..... FS720  
 861-28 Series..... (pg.21) ..... FS520  
 861-P..... (pg.20) ..... F720-30

### ROOF DRAINS

**Shiux Chief**..... **MIFAB**  
 867-L Series..... (see MPB book) ..... F1810  
 867-P Series..... (pg.17) ..... R100-30  
 868 Series..... (pg.17) ..... R200  
 868-D Series..... (see MPB book) ..... R1270  
 868-201 Series..... (see MPB book) ..... R1260  
 868-I Series..... (pg.17) ..... R100-M  
 868-P Series..... (pg.17) ..... R100-30

### JRS TO MIFAB®

#### BACKWATER VALVES

**JRS**..... **MIFAB**  
 701-02..... (see MPB book) ..... BV1252  
 701-03..... (see MPB book) ..... BV1253  
 701-04..... (see MPB book) ..... BV1254  
 705 Series..... Contact MIFAB  
 706 Series..... Contact MIFAB

#### CLEANOUTS

**JRS**..... **MIFAB**  
 405-04..... (pg.17) ..... C234-TS-1  
 405-05..... (pg.17) ..... C236-TS-1  
 405-06..... (pg.17) ..... C236-TS-1  
 406-06..... (pg.13) ..... S-1-TS-1  
 406-05..... (see MPB book) ..... 6S-1-TS-1  
 410-L02..... (pg.13) ..... A4-2P-7-CL  
 410-L03..... (pg.13) ..... A4-3P-7-CL  
 410-L04..... (pg.13) ..... A4-4P-7-CL  
 410-LXH02..... (pg.13) ..... A4-2P-7-CL  
 410-LXH03..... (pg.13) ..... A4-3P-7-CL  
 410-LXH04..... (pg.13) ..... A4-4P-7-CL  
 410-Y02..... (pg.13) ..... A4-2NH-7-CL  
 410-Y03..... (pg.13) ..... A4-3NH-7-CL  
 410-Y04..... (pg.13) ..... A4-4NH-7-CL  
 410-10..... (pg.13) ..... XR-4-CL  
 410-11..... (pg.13) ..... XR-4-CL  
 410-13..... (pg.13) ..... S-1-CL  
 410-14..... (see MPB book) ..... UR-1-CL  
 420-L02..... (pg.12) ..... C222P-XR-4  
 420-L03..... (pg.12) ..... C223P-XR-4

CALIFORNIA PROPOSITION 65 WARNING. This product contains chemicals known to the State of California to cause cancer and birth defects or other reproductive harm.



420-L04 ..... (see MPB book) ..... C1234P-4  
 420-LXH02 ..... (pg.12) ..... C222P-XR-4  
 420-LXH03 ..... (pg.12) ..... C223P-XR-4  
 420-LXH04 ..... (see MPB book) ..... C1234P-4  
 420-LXH06 ..... (see MPB book) ..... C1226P-4

### FLOOR & AREA DRAINS

**JRS..... MIFAB**  
 201-T03 ..... (pg.13) ..... 5-1-CL  
 210-L02 ..... (pg.13) ..... A4-2P-7-CL  
 210-L03 ..... (pg.13) ..... A4-3P-7-CL  
 210-L04 ..... (pg.13) ..... A4-4P-7-CL  
 210-LXH02 ..... (pg.13) ..... A4-2P-7-CL  
 210-LXH03 ..... (pg.13) ..... A4-3P-7-CL  
 210-LXH04 ..... (pg.13) ..... A4-4P-7-CL  
 210-Y02 ..... (pg.13) ..... A4-2NH-7-CL  
 210-Y03 ..... (pg.13) ..... A4-3NH-7-CL  
 210-Y04 ..... (pg.13) ..... A4-4NH-7-CL  
 210-10 ..... (pg.13) ..... X5-4-CL  
 210-11 ..... (pg.13) ..... X5-4-CL  
 210-12 ..... (pg.13) ..... 5-1-CL  
 210-13 ..... (pg.13) ..... S5-1-CL  
 210-14 ..... (pg.13) ..... 6-1-CL  
 210-15 ..... (pg.13) ..... S6-1-CL  
 220-C02 ..... (pg.13) ..... A1-2X-7-CL  
 220-T02 ..... (pg.13) ..... A1-2T-7-CL  
 220-10 ..... (see MPB book) ..... 5-49-CL  
 220-11 ..... (pg.13) ..... 5-1-CL  
 221-T02 ..... (see MPB book) ..... F1122T-7

### FLOOR SINKS

**JRS..... MIFAB**  
 301-H03 ..... (pg.20) ..... FS523-PB-30  
 301-H04 ..... (pg.20) ..... FS524-PB-30  
 301-10 ..... (pg.20) ..... FS520-PG-30  
 301-12 ..... (pg.20) ..... FS520-PG-150-30  
 301-13 ..... (pg.20) ..... FS520-PG-175-30  
 301-14 ..... (pg.20) ..... FS1500-PD  
 302-H02 ..... (pg.20) ..... FS722-PB-30  
 302-H03 ..... (pg.20) ..... FS723-PB-30  
 302-H04 ..... (pg.20) ..... FS724-PB-30  
 302-10 ..... (pg.20) ..... FS700-PG-30  
 302-12 ..... (pg.20) ..... FS700-PG-150-30  
 302-13 ..... (pg.20) ..... FS700-PG-175-30  
 320-Y02 ..... (pg.21) ..... FS722-PB  
 320-Y03 ..... (pg.21) ..... FS723-PB  
 320-Y04 ..... (pg.21) ..... FS724-PB  
 320-10 ..... (pg.21) ..... FS700-PG  
 320-11 ..... (pg.21) ..... FS700-PG-150-SPL  
 320-12 ..... (pg.21) ..... FS700-PG-150  
 320-13 ..... (pg.21) ..... FS700-PG-175  
 325-Y02 ..... (pg.21) ..... FS722-FL-PB  
 325-Y03 ..... (pg.21) ..... FS723-FL-PB  
 325-Y04 ..... (pg.21) ..... FS724-FL-PB  
 330-Y02 ..... (pg.21) ..... FS732-PB  
 330-Y03 ..... (pg.21) ..... FS733-PB  
 330-Y04 ..... (pg.21) ..... FS734-PB  
 335-Y02 ..... (pg.21) ..... FS732-FL-PB  
 335-Y03 ..... (pg.21) ..... FS733-FL-PB  
 335-Y04 ..... (pg.21) ..... FS734-FL-PB

340-Y02 ..... (pg.21) ..... FS742-PB  
 340-Y03 ..... (pg.21) ..... FS743-PB  
 340-Y04 ..... (pg.21) ..... FS744-PB  
 345-Y02 ..... (pg.21) ..... FS742-FL-PB  
 345-Y03 ..... (pg.21) ..... FS743-FL-PB  
 345-Y04 ..... (pg.21) ..... FS744-FL-PB

### HYDRANTS

**JRS..... MIFAB**  
 560-10 ..... (pg.30) ..... HY-9040-NPB  
 560-11 ..... (pg.30) ..... HY-9041-NPB  
 560-12 ..... (pg.30) ..... HY-9040-NPB  
 560-13 ..... (pg.30) ..... HY-9241-NPB

### ROOF DRAINS

**JRS..... MIFAB**  
 101 Series ..... (pg.17) ..... R100-30  
 110 Series ..... (pg.17) ..... R100  
 111 Series ..... (see MPB book) ..... R100-R  
 148 Series ..... (pg.17) ..... R150

### WATTS TO MIFAB®

#### BACKWATER VALVES

**WATTS..... MIFAB**  
 BV2 ..... (see MPB book) ..... BV1252  
 BV3 ..... (see MPB book) ..... BV1253  
 BV4 ..... (see MPB book) ..... BV1254

#### CLEANOUTS

**WATTS..... MIFAB**  
 CO5-2PVC ..... (see MPB book) ..... C1232-30-4  
 CO5-2PVC-NB ..... (see MPB book) ..... C1232-30-1  
 CO5-2ABS ..... (see MPB book) ..... C1232-31-4  
 CO5-2ABS-NB ..... (see MPB book) ..... C1232-31-1  
 CO5-2NH ..... (see MPB book) ..... C1232-4  
 CO5-2NH-NB ..... (see MPB book) ..... C1232-1  
 CO5-3PVC ..... (see MPB book) ..... C1233-30-4  
 CO5-3PVC-NB ..... (see MPB book) ..... C1233-30-1  
 CO5-3ABS ..... (see MPB book) ..... C1233-31-4  
 CO5-3ABS-NB ..... (see MPB book) ..... C1233-31-1  
 CO5-3NH ..... (see MPB book) ..... C1233-4  
 CO5-3NH-NB ..... (see MPB book) ..... C1233-1  
 CO5-4PVC ..... (see MPB book) ..... C1234-30-4  
 CO5-4PVC-NB ..... (see MPB book) ..... C1234-30-1  
 CO5-4ABS ..... (see MPB book) ..... C1234-31-4  
 CO5-4ABS-NB ..... (see MPB book) ..... C1234-31-1  
 CO5-4NH ..... (see MPB book) ..... C1234-4  
 CO5-4NH-NB ..... (see MPB book) ..... C1234-1  
 CO6-2NH ..... (see MPB book) ..... C1232-4  
 CO6-3NH ..... (see MPB book) ..... C1233-4  
 CO6-4NH ..... (see MPB book) ..... C1234-4  
 CO12 Series ..... (pg.12) ..... C220  
 CO20 Series ..... (pg.12) ..... C220  
 CO26 Series ..... Contact MIFAB  
 CO38-2NH ..... (see MPB book) ..... C1232-1  
 CO38-3NH ..... (see MPB book) ..... C1233-1  
 CO38-4NH ..... (see MPB book) ..... C1234-1  
 CO38-6NH ..... (see MPB book) ..... C1236-1  
 CO-413 ..... (pg.17) ..... C234-TS-4

CO-413-1 ..... (pg.17) ..... C234-TS-1  
 CO-414 ..... (pg.17) ..... C236-TS-4  
 CO-414-1 ..... (pg.17) ..... C236-TS-1  
 CO-416 Series ..... Contact MIFAB  
 CO44-1.5 ..... (see MPB book) ..... C1441.5-RD4  
 CO44-2 ..... (see MPB book) ..... C1442-RD4  
 CO44-3 ..... (see MPB book) ..... C1443-RD5  
 CO44-4 ..... (see MPB book) ..... C1444-RD6  
 CO44-6 ..... (see MPB book) ..... C1446-RD10  
 CO48-5 ..... (see MPB book) ..... C1400-RD5  
 CO48-6 ..... (see MPB book) ..... C1400-RD6  
 CO48-7 ..... (see MPB book) ..... C1400-RD8  
 CO48-8 ..... (see MPB book) ..... C1400-RD8  
 CO48-10 ..... (see MPB book) ..... C1400-RD10  
 CO58 Series ..... (see MPB book) ..... C1430  
 CO59-1.5 ..... (see MPB book) ..... C1430-1.5-RD4  
 CO59-2 ..... (see MPB book) ..... C1432-RD4  
 CO59-3 ..... (see MPB book) ..... C1433-RD4  
 CO59-4 ..... (see MPB book) ..... C1434-RD6  
 CO59-6 ..... (see MPB book) ..... C1436-RD8

#### CLOSET FLANGES

**WATTS..... MIFAB**  
 CF-32 ..... (pg.18) ..... CF32TC  
 CF-42 ..... (pg.18) ..... CF42TC  
 CF-44 ..... (pg.18) ..... CF44DTC

#### FLOOR DRAINS

**WATTS..... MIFAB**  
 FD4-2 ..... (pg.16) ..... FD-962  
 FD4-3 ..... (pg.16) ..... FD-963  
 FD4-4 ..... (pg.16) ..... FD-964  
 FD5 Series ..... (pg.15) ..... FD230  
 FD6-2NH ..... (pg.15) ..... FD242-2  
 FD6-3NH ..... (pg.15) ..... FD243-3  
 FD6-4NH ..... (pg.15) ..... FD244-4  
 FD7 Series ..... (pg.10) ..... F100-C Series  
 FD9 Series ..... (pg.15) ..... FD230-WF  
 FD11 Series ..... (see MPB book) ..... F1100  
 FD12 Series ..... (pg.8) ..... F220  
 FD15 Series ..... (pg.10) ..... F100-C  
 FD20 Series ..... (pg.8) ..... F220  
 FD30 Series ..... (pg.11) ..... F300  
 FD31 Series ..... (pg.11) ..... F300  
 FD32 Series ..... (pg.11) ..... F320  
 FD34 Series ..... (see MPB book) ..... F1340  
 FD46 Series ..... (see MPB book) ..... F1440  
 SD-2ABS ..... (pg.14) ..... SD7002  
 SD-2NH ..... (pg.14) ..... SD7000  
 SD-2THD ..... (pg.14) ..... SD7002-T  
 SD-3NH ..... (pg.14) ..... SD7000  
 SDCP-2THD ..... (pg.14) ..... FD212TC-49

#### FLOOR SINKS

**WATTS..... MIFAB**  
 FD55 Series ..... (pg.21) ..... FS720  
 FD56-2PVC ..... (pg.20) ..... FS722-30  
 FD56-3PVC ..... (pg.20) ..... FS723-30  
 FD56-4PVC ..... (pg.20) ..... FS724-30

### WALL HYDRANTS

**WATTS..... MIFAB**  
 HY1 Series ..... (pg.27) ..... HY-1000  
 HY2 Series ..... (pg.27) ..... HY-2000  
 HY4 ..... (pg.27) ..... HY-3000  
 HY5 ..... (pg.27) ..... HY-3500  
 HY5-3 ..... (pg.27) ..... HY-3500-3  
 HY8 Series ..... (pg.28) ..... HY-4500

### ROOF DRAINS

**WATTS..... MIFAB**  
 RD1 Series ..... (pg.17) ..... R100  
 RD10 Series ..... (pg.17) ..... R200  
 RD25-2NH ..... (pg.17) ..... R152  
 RD25-3NH ..... (pg.17) ..... R153  
 RD25-4NH ..... (pg.17) ..... R154  
 RD28-2NH ..... (pg.17) ..... R102  
 RD28-2NH-SO ..... (pg.17) ..... R102-90  
 RD28-3NH ..... (pg.17) ..... R103  
 RD28-3NH-SO ..... (pg.17) ..... R103-90  
 RD28-4NH ..... (pg.17) ..... R104  
 RD28-4NH-SO ..... (pg.17) ..... R104-90

### WOODFORD TO MIFAB®

#### HYDRANTS

**Woodford..... MIFAB**  
 24P ..... (pg.30) ..... HY-9040-NPB  
 B24 1/2 or 3/4 ..... (pg.30) ..... HY-9500  
 B5C, 65P ..... (pg.27) ..... HY-1000  
 B65C, B65P ..... (pg.27) ..... HY-2000  
 67C, 67P ..... (pg.27) ..... HY-1000  
 B67C, B67P ..... (pg.27) ..... HY-2000  
 HC67 ..... (pg.28) ..... HY-4000  
 HCB67 ..... (pg.28) ..... HY-4500  
 70C, 70P ..... (pg.27) ..... HY-1000  
 74C, 74P ..... (pg.27) ..... HY-3000  
 B74C, B74P ..... (pg.27) ..... HY-3500  
 75 ..... (pg.28) ..... HY-5000  
 B75 ..... (pg.28) ..... HY-5500  
 76C, 76P ..... (pg.27) ..... HY-3000  
 B76C, B76P ..... (pg.27) ..... HY-3500  
 79 ..... (pg.28) ..... HY-5000  
 B79 ..... (pg.28) ..... HY-5500  
 R34 ..... (pg.29) ..... HY-6800  
 RHY1 ..... (see MPB book) ..... MHY-58  
 RHY2 ..... (see MPB book) ..... MHY-58  
 W34 ..... (pg.29) ..... HY-6800  
 X34 ..... (pg.29) ..... HY-6800  
 Y1 ..... (pg.29) ..... HY-6800  
 Y2 ..... (pg.29) ..... HY-6800  
 Y30 ..... (pg.29) ..... HY-6500  
 Y34 ..... (pg.29) ..... HY-6800  
 Y95 ..... (pg.29) ..... HY-6000

#### VACUUM BREAKERS

**Woodford..... MIFAB**  
 34H (brass) ..... (pg.31) ..... HY-9005-B  
 34H (chrome) ..... (pg.31) ..... HY-9005-CP  
 37HA ..... (pg.31) ..... HY-9006-CP

CALIFORNIA PROPOSITION 65 WARNING. This product contains chemicals known to the State of California to cause cancer and birth defects or other reproductive harm.

Design and dimensions are subject to modification. Prices do not include applicable taxes.

Visit [www.mifab.com](http://www.mifab.com) for the most recent product information.

MIFAB®, Inc., 1321 West 119th Street, Chicago, Illinois 60643-5109, USA

Toll Free: 1-800-465-2736, Fax: 1-773-341-3049

All sales subject to MIFAB's® Terms and Warranties. Please refer to page 3.

sales@mifab.com Canada Toll Free: 1-800-387-3880

### ZURN LIGHT COMMERCIAL TO MIFAB®

#### CLEANOUTS

<b>Zurn Light.....</b>	<b>MIFAB</b>
CO.....(pg.12).....C220-30-R or S-1	
CO2400 Series.....(see MPB book).....C1230	
CO2440,50 Series.....(pg.12).....C220	
CO2500 Series.....(pg.12).....C220	
CO2510-PO4.....(see MPB book).....C1234P-4	
CO2520 2".....(pg.18).....C233-TS-4	
CO2520 3".....(pg.18).....C234-TS-4	
CO2520 4".....(pg.18).....C236-TS-4	
CO2521 3".....(pg.18).....C234-TS-1	
CO2521 4".....(pg.18).....C236-TS-1	
CO2530-SS5.....(see MPB book).....C1400-RD5	
CO2530-SS7.....(see MPB book).....C1400-RD7	

#### CLOSET FLANGES

<b>Zurn Light.....</b>	<b>MIFAB</b>
CF2980-CI3.....(pg.17).....CF32	
CF2980-CI4.....(pg.17).....CF42	
CF2982-CI3.....(pg.17).....CF32TC	
CF2982-CI4.....(pg.17).....CF42TC	
CF2983-CI4.....(pg.17).....CFOS42	
CF2984-CI4.....(pg.17).....CF44D	

#### FLOOR DRAINS

<b>Zurn Light.....</b>	<b>MIFAB</b>
FD-B1NH2-BL5.....(pg.16).....FD652	
FD-B1NH3-BL5.....(pg.16).....FD653	
FD-B1NH4-BL5.....(pg.16).....FD654	
FD2200 Series.....(pg.15).....FD230	
FD2200 Series.....(pg.8).....F220	
FD2220 Series.....(pg.15).....FD230	
FD2240 Series.....(pg.15).....FD230-WF	
FD2240-NH3-NT.....(pg.15).....FD233-50-WF-1	
FD2240-NH4.....(pg.15).....FD243-50-WF-4	
FD2240-NH4-NT.....(pg.15).....FD243-50-WF-1	
FD2250-AB15.....(pg.14).....SD7001	
FD2250-AB2.....(pg.14).....SD7002	
FD2250-IP15.....(pg.14).....SD7101	
FD2250-IP2.....(pg.14).....SD7102	
FD2251-AB2.....(pg.16).....50-SD-NH-31	
FD2251-QF2.....(pg.16).....50-SD-TC	
FD2252-QF2.....(pg.16).....50-SD-TC	
FD2254-AB2.....(pg.14).....SD7002	
FD2250 Series.....(pg.10).....F100-C	
FD2280 Series.....(pg.10).....F100-C	
FD2290 Series.....(pg.10).....F100-C	
FD2300 Series.....(pg.10).....F100-C	
FD2310 Series.....(pg.10).....F100-C	
FD2320 Series.....(pg.9).....F100	
FD2321 Series.....(pg.10).....F100-C	
FD2322 Series.....(pg.9).....F100	
FD2330 Series.....(pg.11).....F320-C	
FD2340 Series.....(pg.11).....F300-C	
FD2350 Series.....(pg.11).....F320-C	
FD2360-ABS.....(pg.11).....F324-31-C-4	

FD2360-PVC.....(pg.11).....F324-30-C-4	
FD2390-SS2.....(pg.16).....FD-962	
FD2390-SS3.....(pg.16).....FD-963	
FD2390-SS4.....(pg.16).....FD-964	
JP2210-AB2.....(pg.13).....A4-2-31-7-CL	
JP2210-AB3.....(pg.13).....A4-3-31-7-CL	
JP2210-AB4.....(pg.13).....A4-4-31-7-CL	
JP2210-PV2.....(pg.13).....A4-2-30-7-CL	
JP2210-PV3.....(pg.13).....A4-3-30-7-CL	
JP2210-PV4.....(pg.13).....A4-4-30-7-CL	
JP2211-ABS-Body.....(pg.13).....A4-31-7-CL body	
JP2211-PVC-Body.....(pg.13).....A4-30-7-CL body	
JP2280-AB2-Assy.....(pg.13).....A1-2-31-7-CL w/ A1-C2-CL	
JP2280-AB3-Assy.....(pg.13).....A1-3-31-7-CL w/ A1-C2-CL	
JP2280-AB4-Assy.....(pg.13).....A1-4-31-7-CL w/ A1-C2-CL	
JP2280-PV2-Assy.....(pg.13).....A1-2-30-7-CL w/ A1-C2-CL	
JP2280-PV3-Assy.....(pg.13).....A1-3-30-7-CL w/ A1-C2-CL	
JP2280-PV4-Assy.....(pg.13).....A1-4-30-7-CL w/ A1-C2-CL	
JP2290-NH2-Assy.....(pg.13).....A1-2NH-7-CL w/ A1-C2-CL	
JP2290-NH3-Assy.....(pg.13).....A1-3NH-7-CL w/ A1-C2-CL	
JP2290-NH4-Assy.....(pg.13).....A1-4NH-7-CL w/ A1-C2-CL	
JP2290-PO2-Assy.....(pg.13).....A1-2P-7-CL w/ A1-C2-CL	
JP2290-PO3-Assy.....(pg.13).....A1-3P-7-CL w/ A1-C2-CL	
JP2290-PO4-Assy.....(pg.13).....A1-4P-7-CL w/ A1-C2-CL	
JP2320-NH2.....(pg.13).....A4-2NH-7-CL	
JP2320-NH3.....(pg.13).....A4-3NH-7-CL	
JP2320-NH4.....(pg.13).....A4-4NH-7-CL	
JP2320-PO2.....(pg.13).....A4-2P-7-CL	
JP2320-PO3.....(pg.13).....A4-3P-7-CL	
JP2320-PO4.....(pg.13).....A4-4P-7-CL	
JP2321-IP2-Assy.....(pg.13).....A1-2T-7-CL w/ A1-C2-CL	
JP2321-IP3-Assy.....(pg.13).....A1-3T-7-CL w/ A1-C2-CL	
JP2321-NH2-Assy.....(pg.13).....A1-2NH-7-CL w/ A1-C2-CL	
JP2321-NH3-Assy.....(pg.13).....A1-3NH-7-CL w/ A1-C2-CL	
JP2321-NH4-Assy.....(pg.13).....A1-4NH-7-CL w/ A1-C2-CL	
JP2321-PO2-Assy.....(pg.13).....A1-2P-7-CL w/ A1-C2-CL	
JP2321-PO3-Assy.....(pg.13).....A1-3P-7-CL w/ A1-C2-CL	
JP2322-IP2.....(pg.13).....A1-2T-7-CL	
JP2322-IP3.....(pg.13).....A1-3T-7-CL	
JP2322-NH2.....(pg.13).....A1-2NH-7-CL	
JP2322-NH3.....(pg.13).....A1-3NH-7-CL	
JP2322-NH4.....(pg.13).....A1-4NH-7-CL	
JP2322-PO2.....(pg.13).....A1-2P-7-CL	
JP2322-PO3.....(pg.13).....A1-3P-7-CL	
JP2280-R4 Nickel Head.....(pg.13).....5-1-CL	
JP2280-R5 Nickel Head.....(pg.13).....5-1-CL	
JP2280-R5-CP Nickel Head.....(pg.13).....5-49-CL	
JP2280-R5-PB Polished Brass.....(pg.13).....5-2-CL	
JP2280-R6 Nickel Head.....(pg.13).....6-1-CL	
JP2280-R7 Nickel Head.....(pg.13).....7-1-CL	
JP2280-R8 Nickel Head.....(pg.13).....8-1-CL	
JP2280-R10 Nickel Head.....(pg.13).....10-1-CL	
JP2280-S5-1.....(pg.13).....S5-1-CL	
JP2280-S5-CP.....(pg.13).....S5-49-CL	
JP2280-S5-PB.....(pg.13).....S5-2-CL	
JP2280-S6.....(pg.13).....S6-1-CL	
JP2280-S8.....(pg.13).....S8-1-CL	
FD-EXTDO Series.....(see MPB book).....SPR-5-1	

#### FLOOR SINKS

<b>Zurn Light.....</b>	<b>MIFAB</b>
FD2370-PV2.....(pg.20).....FS722-30-PB	
FD2370-PV3.....(pg.20).....FS723-30-PB	
FD2370-PV4.....(pg.20).....FS724-30-PB	
FD2375-NH2.....(pg.21).....FS722-PB	
FD2375-NH3.....(pg.21).....FS723-PB	
FD2375-NH4.....(pg.21).....FS724-PB	
FD2376-NH2.....(pg.21).....FS732-PB	
FD2376-NH3.....(pg.21).....FS733-PB	
FD2376-NH4.....(pg.21).....FS734-PB	
FD2377-NH2.....(pg.21).....FS742-PB	
FD2377-NH3.....(pg.21).....FS743-PB	
FD2377-NH4.....(pg.21).....FS744-PB	
FD2378-NH2.....(pg.21).....FS522-PB	
FD2378-NH3.....(pg.21).....FS523-PB	
FD2378-NH4.....(pg.21).....FS524-PB	

#### HYDRANTS

<b>Zurn Light.....</b>	<b>MIFAB</b>
Z1320-C.....(pg.27).....HY-2000	
Z1320-C-BFP.....(pg.27).....HY-2000	
Z1321-C.....(pg.27).....HY-1000	
Z1321-C-BFP.....(pg.27).....HY-1000	
Z1330-C.....(pg.27).....HY-3500	
Z1330-C-BFP.....(pg.27).....HY-3500	
Z1333-C.....(pg.27).....HY-3000	
Z1333-C-BFP.....(pg.27).....HY-3000	
Z1334-C.....(pg.27).....HY-3000	
Z1334-C-BFP.....(pg.27).....HY-3000	
Z1341.....(pg.30).....HY-9240-NPB	
Z1341-52.....(pg.30).....HY-9000-52	
Z1342.....(pg.30).....HY-9500	
Z1342-BFP.....(pg.30).....HY-9500-52	
Z1343.....(pg.30).....HY-9240-NPB	
Z1343-BFP.....(pg.30).....HY-9240-NPB	
Z1349.....(pg.28).....HY-5000	
Z1349-BFP.....(pg.28).....HY-5000	
Z1361.....(pg.29).....HY-6000	
Z1391.....(pg.29).....HY-6500	
Z1396.....(pg.29).....HY-6800	
Z1399-BFP.....(pg.31).....HY-9006-CP	
Z1399-VB.....(pg.31).....HY-9005	

#### PARTS

<b>Zurn Light.....</b>	<b>MIFAB</b>
B1-NH2.....(pg.13).....A1-2NH-7-CL	
B1-NH3.....(pg.13).....A1-3NH-7-CL	
B1-NH4.....(pg.13).....A1-4NH-7-CL	
B1-P02.....(pg.13).....A1-2P-7-CL	
B1-P03.....(pg.13).....A1-3P-7-CL	
B1-P04.....(pg.13).....A1-4P-7-CL	
B3-AB2.....(pg.13).....A1-2-31-7-CL	
B3-AB3.....(pg.13).....A1-3-31-7-CL	
B3-AB4.....(pg.13).....A1-4-31-7-CL	
B3-PV2.....(pg.13).....A1-2-30-7-CL	
B3-PV3.....(pg.13).....A1-3-30-7-CL	
B3-PV4.....(pg.13).....A1-4-30-7-CL	
B4-AB2.....(pg.13).....A4-2-31-7-CL	

B4-AB3.....(pg.13).....A4-3-31-7-CL	
B4-AB4.....(pg.13).....A4-4-31-7-CL	
B4-PV2.....(pg.13).....A4-2-30-7-CL	
B4-PV3.....(pg.13).....A4-3-30-7-CL	
B4-PV4.....(pg.13).....A4-4-30-7-CL	
C1.....(see MPB book).....A1-C2-CL	
C2.....(see MPB book).....A1-C3-CL	
C2-89.....(see MPB book).....A1-WD-CL	
C3.....(see MPB book).....A2-C3-CL	
C3-89.....(see MPB book).....A2-WD-CL	
CR5.....(pg.13).....R-1-CL	
CS5.....(pg.13).....S-1-CL	
D1.....(pg.17).....A1-MD-CL	
D2.....(pg.17).....A1-MD-CL	
D3.....(pg.17).....A1-PD-CL	
JP2080-C.....(see MPB book).....A1-C3-CL	
JP2080-E.....(see MPB book).....A1-C3-CL	
JP2080-R.....(see MPB book).....A1-BP-CL	
JP2080-VP.....(see MPB book).....6	
N7.....(see MPB book).....F300-TA-4	
N9.....(see MPB book).....F320-TA-4	
R4.....(pg.13).....5-1-CL	
R5.....(pg.13).....5-1-CL	
R6.....(pg.13).....6-1-CL	
R7.....(pg.13).....8-1-CL	
R8.....(pg.13).....8-1-CL	
R10.....(pg.13).....10-1-CL	
S5.....(pg.13).....S5-1-CL	
S6.....(pg.13).....S6-1-CL	
S8.....(pg.13).....S8-1-CL	
-U.....(pg.16).....DD-50-CL	
-Y.....(pg.16).....A1-PB-CL	
-4.....(pg.16).....F4-50-CL	
-6.....(pg.16).....F6-50-CL	
-9.....(pg.16).....G-50-CL	

#### ROOF DRAINS

<b>Zurn Light.....</b>	<b>MIFAB</b>
RD2080 Series.....(pg.17).....R100	
RD2090 Series.....(pg.17).....R100	
RD2120 Series.....(pg.17).....R100	
RD2130-NH2.....(pg.17).....R152	
RD2130-NH3.....(pg.17).....R153	
RD2130-NH4.....(pg.17).....R154	
RD2131-NH2.....(pg.17).....R102-B	
RD2131-NH3.....(pg.17).....R103-B	
RD2131-NH4.....(pg.17).....R104-B	
RD2150-SS3.....(pg.18).....RFD-3	
RD2150-SS4.....(pg.18).....RFD-4	
RD2150-SS5.....(pg.18).....RFD-5	
RD2150-SS6.....(pg.18).....RFD-6	
RD2190.....(see MPB book).....R1810	
RD2191.....(pg.19).....R1800	

CALIFORNIA PROPOSITION 65 WARNING. This product contains chemicals known to the State of California to cause cancer and birth defects or other reproductive harm.

**MIFAB CATALOGS**



**MPB-2025-USA  
SPECIFICATION DRAINAGE  
PRODUCTS  
(LIT-067)**



**CLPB-2025  
LIGHT COMMERCIAL  
PRODUCTS  
(LIT-048)**



**AD-2024-USA  
ACCESS DOORS  
(LIT-043)**



**BEECO-2025  
BACKFLOW PREVENTERS,  
AND ACCESSORIES  
(LIT-071)**



**NH-2022-06  
NO HUB COUPLINGS  
(LIT-044)**



**TDFC-2025  
POLYMER CONCRETE  
TRENCH DRAINS  
(LIT-076)**



**TD-2025  
GRP & STEEL  
TRENCH DRAINS  
(LIT-046)**



**TDS-2025  
SHOWER DRAINS  
(LIT-077)**



**TDS-2025  
STAINLESS STEEL  
TRENCH DRAINS  
(LIT-072)**



**ROOFGUARD-2020  
ROOFGUARD ROOF  
DOMES  
(LIT-058)**



**C-PORT-2023  
ROOFTOP RUBBER  
PIPE SUPPORTS  
(LIT-047)**



**DB-2024  
DIALYSIS BOXES  
(LIT-070)**



**HYDROMAX-2020  
SIPHONIC DRAINAGE  
(LIT-082)**



**INT-2025  
INTERCEPTORS & ACID  
NEUTRALIZATION TANKS  
(LIT-095)**



**TSP-2024  
TRAP SEAL  
PRIMERS  
(LIT-062)**



CALIFORNIA PROPOSITION 65 WARNING. This product contains chemicals known to the State of California to cause cancer and birth defects or other reproductive harm.

Design and dimensions are subject to modification. Prices do not include applicable taxes.

Visit [www.mifab.com](http://www.mifab.com) for the most recent product information.

MIFAB®, Inc., 1321 West 119th Street, Chicago, Illinois 60643-5109, USA

Toll Free: 1-800-465-2736, Fax: 1-773-341-3049

All sales subject to MIFAB's® Terms and Warranties. Please refer to page 3.

sales@mifab.com Canada Toll Free: 1-800-387-3880



**CLPB-2025**

# CLPB CATALOG 2025

**LIGHT COMMERCIAL  
DRAINAGE PRODUCTS**

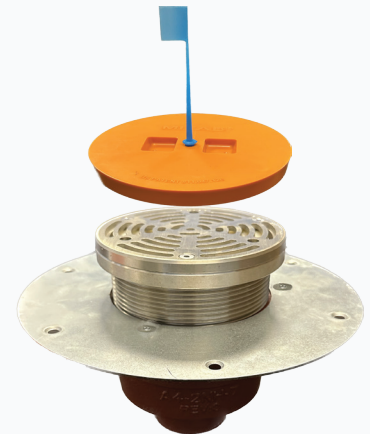
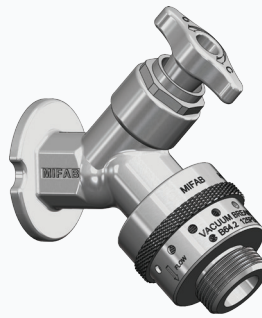

**LIT-048**