



**AD-2025-CAN**



# ACCESS DOORS CATALOG 2025

ACCESS DOORS

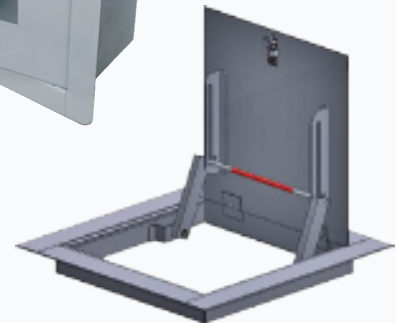

UNIVERSAL

-



















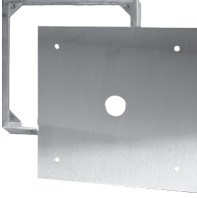

DRYWALL BEAD

-

FIRE RATED

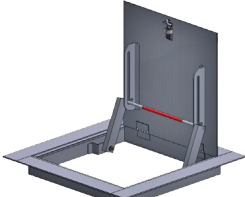
**LIT-051**

**PICTORIAL INDEX**

 <p><b>SERIES UA</b> UNIVERSAL ACCESS DOOR (PAGE 4)</p>	 <p><b>SERIES MDW</b> DRYWALL BEAD ACCESS DOOR (PAGE 5)</p>	 <p><b>SERIES CAD</b> CEILING OR WALL ACCESS DOOR (PAGE 5)</p>	 <p><b>SERIES CAD-DW</b> CEILING OR WALL ACCESS DOOR WITH DRYWALL BEAD (PAGE 6)</p>
 <p><b>SERIES CAD-PL</b> CEILING OR WALL ACCESS DOOR, PLASTER FINISH (PAGE 6)</p>	 <p><b>SERIES CAD-FL</b> CEILING OR WALL ACCESS DOOR, FLUSH DOOR WITH FRAME (PAGE 7)</p>	 <p><b>SERIES CAD-FL-PL</b> CEILING OR WALL ACCESS DOOR, FLUSH DOOR WITH FRAME, PLASTER FINISH (PAGE 7)</p>	 <p><b>SERIES CAD-FR</b> CEILING OR WALL ACCESS DOOR, FIRE RESISTANT (PAGE 8)</p>
 <p><b>SERIES MPFR</b> INSULATED FIRE RATED ACCESS DOOR (PAGE 9)</p>	 <p><b>SERIES MFRU</b> UNINSULATED FIRE RATED ACCESS DOOR (PAGE 10)</p>	 <p><b>SERIES MPFR-DW</b> INSULATED FIRE RATED ACCESS DOOR WITH DRYWALL BEAD FRAME (PAGE 11)</p>	 <p><b>SERIES MI-SAD</b> MEDIUM SECURITY ACCESS DOOR (PAGE 12)</p>
 <p><b>SERIES MI-SADH</b> HIGH SECURITY ACCESS DOOR (PAGE 12)</p>	 <p><b>SERIES MI-FVP</b> FLUSH VALVE PANEL (PAGE 13)</p>	 <p><b>SERIES MI-SF</b> SURFACE ACCESS DOOR (PAGE 13)</p>	 <p><b>SERIES MI-VB, MI-VB-SM</b> VALVE BOX (PAGE 14)</p>
 <p><b>MI-VB-SM WITH OPTIONAL CUT OUT</b> OF DOOR TO ALLOW FOR GLASS OR PLASTIC WINDOW BY OTHERS. (PAGE 14)</p>	 <p><b>SERIES PA</b> PLASTIC ACCESS DOOR (PAGE 15)</p>	 <p><b>SERIES FHA, FHG</b> FLOOR ACCESS DOOR (PAGE 15)</p>	 <p><b>SERIES RHA, RHG</b> ROOF HATCH (PAGE 16)</p>
 <p><b>LOCKS AND LATCHES</b> (PAGE 16)</p>		 <p><b>SERIES WID</b> EXTERIOR ACCESS DOOR/ WALK-IN DOOR (PAGE 17)</p>	

**TABLE OF CONTENTS**

	DISCOUNT		DISCOUNT
<b>UA - Universal</b> .....	4	<b>MI-SAD - Medium Security</b> .....	12
<b>MDW - Drywall Bead</b> .....	5	<b>MI-SADH - High Security</b> .....	12
<b>CAD - 5/8" Recess for Drywall</b> .....	5	<b>MI-FVP - Flush Valve Panel</b> .....	13
<b>CAD-DW - 5/8" Recess for Drywall with Drywall Bead</b> .....	6	<b>MI-SF - Surface</b> .....	13
<b>CAD-PL - 5/8" Recess for Drywall with Plaster Lathe</b> .....	6	<b>MI-VB, MI-VB-SM - Valve Boxes</b> .....	14
<b>CAD-FL - 5/8" Recess in Frame, Door Flush with Frame</b> .....	7	<b>PA - Plastic</b> .....	15
<b>CAD-FL-PL - 5/8" Recess in Frame, Door Flush with Frame</b> .....	7	<b>FHA, FHG - Floor Access</b> .....	15
<b>CAD-FR - 1 1/2" Recess for Drywall</b> .....	8	<b>RHA, RHG - Roof Hatches</b> .....	16
<b>MPFR - Insulated, Fire Rated</b> .....	9	<b>Locks and Latches - Illustrated Locks Available</b> .....	16
<b>MFRU - Uninsulated, Fire Rated</b> .....	10	<b>WID - Exterior Access</b> .....	17
<b>MPFR-DW - Insulated, Fire Rated with</b>		<b>Cross Reference</b> .....	18

**TERMS AND WARRANTIES**

**WHOLESALE DISCOUNT:**

Contact MIFAB® or your local representative for your applicable discount structure.

**FREIGHT ALLOWANCE:** Ex Works, MIFAB’s Chicago, Illinois Factory or Manufacturer Representative’s warehouse with full motor freight allowed on shipments of \$3,500.00 Net or more, within Canada. MIFAB reserves the right to choose the carrier and route of shipment. There is no allowance for United Parcel Service, Federal Express or Shipment by air service. Full motor freight is allowed on shipments of \$3,500.00 Net or more, within Canada for any combination of BEECO, Counterline, No Hub Coupling, Trench Drain, Access Door and Trap Seal Primer products. Shipping dates are estimates and time of delivery is not the essence of the sale of the contract. Therefore, under no circumstances will MIFAB® have any responsibility on account of any delays in manufacture, transportation, or otherwise. Additional freight services such as construction site delivery, lift gate delivery service, re-consigned freight or notification charges, are not included in full freight allowance terms, and will result in additional freight charges. Note: there is no freight allowance for the SL Series of seamless access panels. All orders of the SL Series panels are freight extra.

**QUOTATION TERMS:** List Price and discount protected for 30 days from date issued by MIFAB®. Orders received within this period must be released for shipment within 30 days from date of purchase order, otherwise, prices will be those that are in effect at the time of shipment.

**PAYMENT TERMS:** Terms of payment are Net 30 days from the date of the invoice. All pricing in Canadian dollars. The Buyer shall pay all sales, consumers, and / or any other applicable taxes. Past due accounts will be subject to a 2% per month service charge from the date of the invoice. If any proceedings be instructed by or against Buyer under any bankruptcy or insolvency law, or if Buyer shall fail to make timely payment on this or any other order, or if, in MIFAB’s judgment, Buyer’s financial situation justifies such action, MIFAB® may, at its election, require payment in advance or cancel the order as to any unshipped item and require payment of its reasonable cancellation charges. If Buyer delays completion of manufacture, MIFAB® may elect to require payment according to percentage of completion. Equipment held for Buyer shall be at Buyer’s risk and expense. In all cases, regardless of partial payment, title to the Products shall remain with MIFAB® until payment for the Products (including any notes given therefore) has been made in full. Should legal action be necessary to enforce payment of an unpaid invoice, the Buyer will assume full responsibility for any court costs and reasonable attorney fees. All orders subject to credit check and approval prior to shipment. Confirmed irrevocable letter of credit or cash in advance of shipment is required for accounts without an established line of credit. Minimum invoice amount is \$100.00. MIFAB® reserves the right to apply a minimum order charge to equal \$100.00. MIFAB’s Accounting Department must be notified of potential pricing errors within 30 days of the invoice date. Any terms and conditions stated on Buyer’s orders which are inconsistent with MIFAB’s quotation and Terms and Warranties shall be of no effect.

**RETURNED GOODS RESTOCKING CHARGE:** Standard product may be returned within a one year period only with written permission from MIFAB®. All products in catalog are not considered Standard. Standard product to be determined by MIFAB®. Returned goods are subject to a 25% restocking charge, plus cost of reconditioning, if necessary, to make material saleable. Material must be returned to MIFAB® freight prepaid only after written permission from MIFAB® to accept the returned material. Buyer must provide copy of the original invoice on which the material was charged. The original outgoing freight cost to ship the order will be deducted from the credit. Credit allowance will be in the form of merchandise credit only-not cash credit which must be used within 12 months of the date of issue. The value of a return must total \$100.00 to qualify for credit allowance. No credit will be allowed for auxiliary tappings, discontinued, or made to order items. Products designated non stock and / or that have been specially made are not subject to return or cancellation.

**LIMITED WARRANTY:** MIFAB® warrants each product against defects in material and workmanship for a period of one year from the date of original shipment. In the event of such defects within the warranty period, MIFAB® will, at its option, replace or recondition the product without charge. This shall constitute the exclusive remedy for breach of warranty, and MIFAB® shall not be responsible for any incidental or consequential damages, including, without limitation, damages or other costs resulting from labor charges, delays, vandalism, negligence, fouling caused by foreign material, damage from adverse water conditions, chemicals, or any other circumstances over which MIFAB® has no control. This warranty shall be invalidated by any abuse, misuse, misapplication or improper installation of the product.

**MIFAB® MAKES NO OTHER WARRANTIES EXPRESSED OR IMPLIED AS PROVIDED IN THIS LIMITED WARRANTY.**

**ILLUSTRATIONS OR TYPICAL INSTALLATIONS:** The typical installations for various products in each product section are intended to illustrate the products and their options. Under no circumstances are they to be construed as recommended installation procedures. Consult local codes and project specifications for proper installation instructions.

**ALL SALES SUBJECT TO MIFAB’s TERMS AND WARRANTIES.**

**NOTE:** Prices and terms are subject to change without notice and supersede all previous quotations. The right is reserved to change or modify product design or construction without prior notice and without incurring any obligation to make similar changes and modifications to product previously or subsequently sold. Contact MIFAB® for any clarification.

CONTENTS © MIFAB® INC. Copyright 2025

Design and dimensions are subject to modification. Prices do not include applicable taxes. Visit [www.mifab.com](http://www.mifab.com) for the most recent product information.

**SERIES UA**

**UNIVERSAL ACCESS DOOR**



**DESCRIPTION**

The MIFAB® UA is a multi-purpose access door. It is designed for flush installation into drywall, block or tile, walls and ceilings. The door features rounded safety corners, concealed hinge, flush with frame fit, a unique light color finish, and a 3/8" turn back in the door panel for extra rigidity and safety.

**SPECIFICATIONS**

**Material:** UA Series is 16 gauge satin coat steel door and 16 gauge satin coat steel frame. The UA55 Stainless Steel Series is 16 gauge #304 stainless steel door and frame. Aluminum doors are available as an option up to the 24" x 24" (610 x 610) size. The door and frame is 16 gauge, Type 5052-32 aluminum.

**Finish:** Satin coat steel doors have a primed finish. Stainless steel doors have a #4 brush satin finish.

**Door:** Flush to frame. Turned back around edges for extra rigidity.

**Frame:** The frame has pre-punched mounting holes for simple installation.

**Hinge:** Concealed pivot pins.

**Latch:** Standard – Flush mounted, screwdriver operated cam. Optional – Allen key, cylinder key, paddle latch, or Vandal resistant (lock only) (lock only) latch. All of MIFAB's cylinder key locks are keyed alike.

**Packaging:** Individual pack.

UA OPTIONAL VARIATIONS		
SUFFIX	DESCRIPTION	LIST PRICE, EACH
-A	Allen key lock	\$29.25
-AL	Aluminum material	Use Stainless Steel List Price for same size door
-C	Cylinder key lock	\$36.75
-PL	Paddle latch	\$110.25
-VP	Vandal resistant (lock only) (lock only)	\$110.25
-WR	Water resistant	\$176.00

**A-B** Door Size  
**C-D** Overall Dimensions -  
 Door Size - Plus 2 1/8"  
**E-F** Wall Opening -  
 Door Size - Plus 3/8"

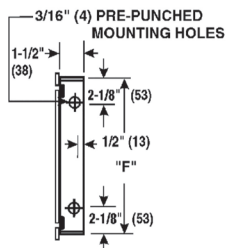
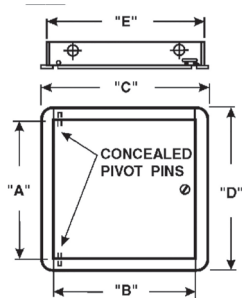

**Note:** The hinge is always furnished on the "A" or height (longer) dimension, unless otherwise specified.

**\* Custom sized access doors are available. Contact your local MIFAB® representative for a quotation for any size access door you need.**

"B" x "A"	WALL OPENING	SHIP WEIGHT (Lbs.)	LATCHES	MILD STEEL MODEL #	LIST PRICE MILD STEEL	STAINLESS STEEL MODEL #	LIST PRICE STAINLESS STEEL
6" x 6"	6-3/8" x 6-3/8"	1.9	1	UA0606	\$32.50	UA550606	\$149.00
8" x 8"	6-3/8" x 8-3/8"	2.8	1	UA0808	\$32.50	UA550808	\$97.25
8" x 12"	8-3/8" x 12-3/8"	3.8	1	UA0812	\$60.50	UA550812	\$210.75
10" x 10"	10-3/8" x 10-3/8"	3.8	1	UA1010	\$42.25	UA551010	\$190.00
12" x 12"	12-3/8" x 12-3/8"	5.0	1	UA1212	\$40.00	UA551212	\$198.75
12" x 16"	12-3/8" x 16-3/8"	6.4	1	UA1216	\$82.00	UA551216	\$258.00
12" x 18"	12-3/8" x 18-3/8"	7.1	1	UA1218	\$86.50	UA551218	\$297.00
12" x 24"	12-3/8" x 24-3/8"	9.3	2	UA1224	\$99.50	UA551224	\$319.75
14" x 14"	14-3/8" x 14-3/8"	6.4	1	UA1414	\$64.75	UA551414	\$359.75
14" x 20"	14-3/8" x 20-3/8"	9.0	2	UA1420	\$67.00	UA551420	\$366.00
14" x 24"	14-3/8" x 24-3/8"	12.0	3	UA1424	\$116.75	UA551424	\$410.50
15" x 15"	15-3/8" x 15-3/8"	7.1	1	UA1515	\$116.75	UA551515	\$385.50
16" x 16"	16-3/8" x 16-3/8"	7.9	1	UA1616	\$67.00	UA551616	\$366.25
16" x 20"	16-3/8" x 20-3/8"	9.7	2	UA1620	\$104.75	UA551620	\$409.50
16" x 24"	16-3/8" x 24-3/8"	11.4	2	UA1624	\$116.75	UA551624	\$410.50
18" x 18"	18-3/8" x 18-3/8"	9.8	3	UA1818	\$92.00	UA551818	\$415.75
18" x 24"	18-3/8" x 24-3/8"	12.7	5	UA1824	\$123.25	UA551824	\$513.00
18" x 36"	18-3/8" x 36-3/8"	18.5	5	UA1836	\$185.75	UA551836	\$582.00
20" x 20"	20-3/8" x 20-3/8"	11.7	3	UA2020	\$122.00	UA552020	\$513.00
20" x 24"	20-3/8" x 24-3/8"	13.8	3	UA2024	\$133.00	UA552024	\$540.00
20" x 30"	20-3/8" x 30-3/8"	16.9	5	UA2030	\$178.25	UA552030	\$576.75
22" x 22"	22-3/8" x 22-3/8"	13.7	3	UA2222	\$141.50	UA552222	\$576.75
22" x 30"	22-3/8" x 30-3/8"	18.2	5	UA2230	\$196.50	UA552230	\$610.25
24" x 24"	24-3/8" x 24-3/8"	15.9	3	UA2424	\$116.50	UA552424	\$576.75
24" x 30"	24-3/8" x 30-3/8"	19.6	5	UA2430	\$191.25	UA552430	\$649.00
24" x 36"	24-3/8" x 36-3/8"	23.2	6	UA2436	\$216.00	UA552436	\$703.00
24" x 48"	24-3/8" x 48-3/8"	28.0	7	UA2448	\$222.50	UA552448	\$757.00
30" x 30"	30-3/8" x 30-3/8"	23.5	7	UA3030	\$216.00	UA553030	\$703.00
32" x 32"	32-3/8" x 32-3/8"	26.4	5	UA3232	\$248.50	UA553232	\$816.50
36" x 36"	36-3/8" x 36-3/8"	32.7	8	UA3636	\$275.50	UA553636	\$901.75
36" x 48"	36-3/8" x 48-3/8"	43.0	5	UA3648	\$491.50	UA553648	\$1,616.75
48" x 48"	48-3/8" x 48-3/8"	46.0	5	UA4848	\$584.25	UA554848	\$1,782.00

**SERIES MDW DRYWALL BEAD ACCESS DOOR**

**DESCRIPTION**

The MIFAB® MDW access door is designed for installation after the drywall has been applied and when a concealed outer flange is required. The outer frame has a galvanized drywall taping bead. Drywall cement can be applied over the beading at the same time as the wallboard joints and corners. Only the door is visible. It has a light color finish.

**SPECIFICATIONS**

**Material:** MDW Series is 16 gauge satin coat steel door and 16 gauge satin coat steel frame. The MDWSS Stainless Steel Series is 16 gauge #304 stainless steel door and frame.

**Finish:** Satin coat steel doors have a primed finish. Stainless steel doors have a #4 brush satin finish.

**Door:** Flush to frame. Turned back around edges for extra rigidity.

**Frame:** Drywall taping bead on all sides.

**Hinge:** Concealed pivot pins.

**Latch:** Standard – Flush mounted, screwdriver operated cam. Optional – Allen key, cylinder key, paddle latch, or Vandal resistant (lock only) (lock only) latch. All of MIFAB's cylinder key locks are keyed alike.

**Packaging:** Individual pack.

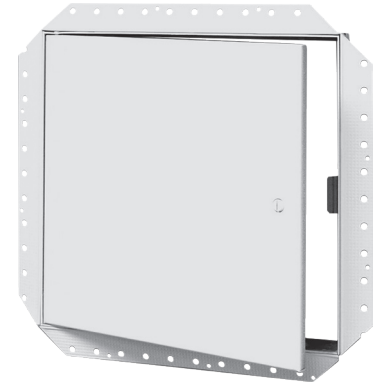

"B" x "A"	WALL OPENING	SHIP WEIGHT (Lbs.)	LATCHES	MILD STEEL MODEL #	LIST PRICE MILD STEEL	STAINLESS STEEL MODEL #	LIST PRICE STAINLESS STEEL
8" x 8"	8-3/8" x 8-3/8"	3.5	1	MDW0808	\$162.00	MDWSS0808	\$503.25
10" x 10"	10-3/8" x 10-3/8"	4.5	1	MDW1010	\$170.75	MDWSS1010	\$536.75
12" x 12"	12-3/8" x 12-3/8"	6.0	1	MDW1212	\$182.50	MDWSS1212	\$570.25
14" x 14"	14-3/8" x 14-3/8"	7.0	1	MDW1414	\$196.50	MDWSS1414	\$617.75
16" x 16"	16-3/8" x 16-3/8"	8.0	1	MDW1616	\$219.25	MDWSS1616	\$678.25
18" x 18"	18-3/8" x 18-3/8"	12.0	3	MDW1818	\$229.00	MDWSS1818	\$720.50
22" x 22"	22-3/8" x 22-3/8"	14.0	3	MDW2222	\$269.00	MDWSS2222	\$864.00
24" x 24"	24-3/8" x 24-3/8"	17.5	3	MDW2424	\$302.50	MDWSS2424	\$947.25
24" x 36"	24-3/8" x 36-3/8"	21.0	5	MDW2436	\$338.00	MDWSS2436	\$1,005.50
30" x 30"	30-3/8" x 30-3/8"	22.0	5	MDW3030	\$338.00	MDWSS3030	\$1,005.50
36" x 36"	36-3/8" x 36-3/8"	32.0	5	MDW3636	\$401.75	MDWSS3636	\$1,141.50

MDW OPTIONAL VARIATIONS		
SUFFIX	DESCRIPTION	LIST PRICE, EACH
-A	Allen key lock	\$29.25
-C	Cylinder key lock	\$36.75
-PL	Paddle latch	\$110.25
-VP	Vandal resistant (lock only)	\$110.25
-WR	Water resistant	\$176.00

**NOTE:** The hinge is always furnished on the "A" or height (longer) dimension, unless otherwise specified.

\* Custom sized access doors are available. Contact your local MIFAB® representative for a quotation for any size access door you need.

**SERIES CAD CEILING OR WALL ACCESS DOOR**

**DESCRIPTION**

The MIFAB® CAD recessed access door is designed for use in acoustical, drywall or tiled surfaces. The door panel is recessed 5/8" (15) to allow the insertion of various types of material.

**SPECIFICATIONS**

**Material:** CAD Series is 16 gauge satin coat steel door and 16 gauge satin coat steel frame.

The CADSS Stainless Steel Series is 16 gauge #304 stainless steel door and frame.

**Finish:** Satin coat steel doors have a primed finish. Stainless steel doors have a #4 brush satin finish.

**Door:** Recessed 5/8" (15) door pan to accept tile, drywall or other finishing materials.

**Frame:** Flush to surface.

**Hinge:** Concealed pivot pins.

**Latch:** Standard – Flush mounted, screwdriver operated cam. Optional – Allen key, cylinder key, or Vandal resistant (lock only) (lock only) latch. All of MIFAB's cylinder key locks are keyed alike.

**Packaging:** Individual pack.



\* Custom sized access doors are available. Contact your local MIFAB® representative for a quotation for any size access door you need.

"B" x "A"	WALL OPENING	SHIP WEIGHT (Lbs.)	LATCHES	MILD STEEL MODEL #	LIST PRICE MILD STEEL	STAINLESS STEEL MODEL #	LIST PRICE STAINLESS STEEL
8" x 8"	8-3/16" x 8-3/16"	4.5	1	CAD0808	\$125.25	CADSS0808	\$388.75
12" x 12"	12-3/16" x 12-3/16"	7.0	1	CAD1212	\$144.75	CADSS1212	\$452.50
12" x 24"	12-3/16" x 24-3/16"	12.0	2	CAD1224	\$188.00	CADSS1224	\$590.75
14" x 14"	14-3/16" x 14-3/16"	9.0	2	CAD1414	\$161.00	CADSS1414	\$502.25
16" x 16"	16-3/16" x 16-3/16"	10.5	2	CAD1616	\$179.25	CADSS1616	\$563.75
18" x 18"	18-3/16" x 18-3/16"	12.0	3	CAD1818	\$195.50	CADSS1818	\$606.00
24" x 24"	24-3/16" x 24-3/16"	18.5	4	CAD2424	\$269.00	CADSS2424	\$831.50
24" x 36"	24-3/16" x 36-3/16"	22.0	5	CAD2436	\$347.75	CADSS2436	\$1,093.00

CAD OPTIONAL VARIATIONS		
SUFFIX	DESCRIPTION	LIST PRICE, EACH
-A	Allen key lock	\$29.25
-C	Cylinder key lock	\$36.75
-VP	Vandal resistant (lock only)	\$110.25

**NOTE:** The hinge is always furnished on the "A" or height (longer) dimension, unless otherwise specified.

Design and dimensions are subject to modification. Prices do not include applicable taxes. Visit [www.mifab.com](http://www.mifab.com) for the most recent product information.



**SERIES CAD-DW CEILING OR WALL ACCESS DOOR WITH DRYWALL BEAD**



**DESCRIPTION**

The MIFAB® CAD-DW recessed access door is designed for use in acoustical, drywall or tiled surfaces. The door panel is recessed 5/8" (15) to allow the insertion of various types of material. It has a light color finish. The outer frame has a galvanized drywall taping bead. Drywall cement can be applied over the beading at the same time as the wallboard joints and corners.

**SPECIFICATIONS**

**Material:** CAD-DW Series is 16 gauge satin coat steel door and 16 gauge satin coat steel frame. The CAD-DWSS is 16 gauge #304 stainless steel door and frame.

**Finish:** Satin coat steel doors have a primed finish. Stainless steel doors have a #4 brush satin finish.

**Door:** Recessed 5/8" (15) door pan to accept tile, drywall or other finishing materials.

**Frame:** Drywall corner bead on all sides.

**Hinge:** Concealed pivot pins.

**Latch:** Standard – Flush mounted, screwdriver operated cam. Optional – Allen key, cylinder key, or Vandal resistant (lock only) (lock only) latch. All of MIFAB's cylinder key locks are keyed alike.

**Packaging:** Individual pack.

\* Custom sized access doors are available. Contact your local MIFAB® representative for a quotation for any size access door you need.

CAD-DW OPTIONAL VARIATIONS		
SUFFIX	DESCRIPTION	LIST PRICE, EACH
-A	Allen key lock	\$29.25
-C	Cylinder key lock	\$36.75
-VP	Vandal resistant (lock only)	\$110.25
-WR	Water resistant	\$176.00

"B" x "A"	WALL OPENING	SHIP WEIGHT (Lbs.)	LATCHES	MILD STEEL MODEL #	LIST PRICE MILD STEEL	STAINLESS STEEL MODEL #	LIST PRICE STAINLESS STEEL
8" x 8"	8-3/16" x 8-3/16"	5.00	1	CAD-DW0808	\$179.25	CAD-DWSS0808	\$563.75
12" x 12"	12-3/16" x 12-3/16"	7.50	1	CAD-DW1212	\$202.00	CAD-DWSS1212	\$629.75
12" x 24"	12-3/16" x 24-3/16"	13.00	2	CAD-DW1224	\$246.25	CAD-DWSS1224	\$770.00
14" x 14"	14-3/16" x 14-3/16"	9.50	2	CAD-DW1414	\$219.25	CAD-DWSS1414	\$678.25
16" x 16"	16-3/16" x 16-3/16"	11.50	2	CAD-DW1616	\$235.50	CAD-DWSS1616	\$742.00
18" x 18"	18-3/16" x 18-3/16"	13.00	3	CAD-DW1818	\$250.50	CAD-DWSS1818	\$778.75
24" x 24"	24-3/16" x 24-3/16"	19.50	4	CAD-DW2424	\$323.00	CAD-DWSS2424	\$1,006.50
24" x 36"	24-3/16" x 36-3/16"	23.00	5	CAD-DW2436	\$407.25	CAD-DWSS2436	\$1,271.25

**NOTE:** The hinge is always furnished on the "A" or height (longer) dimension, unless otherwise specified.

**SERIES CAD-PL CEILING OR WALL ACCESS DOOR, PLASTER FINISH**

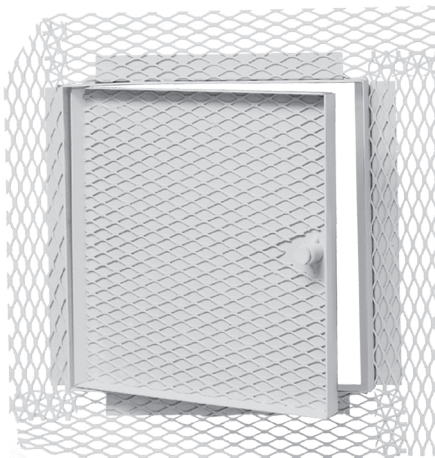

**DESCRIPTION**

The MIFAB® CAD-PL recessed access door is designed for use in acoustic plaster walls and ceilings. The door panel is recessed 5/8" (15) and is lined with a self-furring metal lath to allow the insertion of plaster within the door panel. A 2 3/4" (70) wide metal lath extends from the perimeter of the frame. Only the thickness of the door and frame edges are exposed. It has a light color finish.

**SPECIFICATIONS**

**Material:** CAD-PL Series is 16 gauge satin coat steel door and 16 gauge satin coat steel frame. The CAD-PLSS Stainless Steel Series is 16 gauge #304 stainless steel door and frame.

**Finish:** Satin coat steel doors have a primed finish. Stainless steel doors have a #4 brush satin finish.

**Door:** Recessed 5/8" (15) door pan with self-furring metal lath to accept plaster.

**Frame:** Mounting flange is 1 1/8" (28) wide and recessed 5/8" (15) from the door and lined with a 2 3/4" (70) wide self-furring metal lath.

**Hinge:** Concealed pivot pins.

**Latch:** Standard - Flush mounted, screwdriver operated cam. Optional – Allen key, cylinder key, or Vandal resistant (lock only) (lock only) latch. All of MIFAB's cylinder key lock are keyed alike.

**Packaging:** Individual pack.

\* Custom sized access doors are available. Contact your local MIFAB® representative for a quotation for any size access door you need.

CAD-PL OPTIONAL VARIATIONS		
SUFFIX	DESCRIPTION	LIST PRICE, EACH
-A	Allen key lock	\$29.25
-C	Cylinder key lock	\$36.75
-VP	Vandal resistant (lock only)	\$110.25

"B" x "A"	WALL OPENING	SHIP WEIGHT (Lbs.)	LATCHES	MILD STEEL MODEL #	LIST PRICE MILD STEEL	STAINLESS STEEL MODEL #	LIST PRICE STAINLESS STEEL
12" x 12"	12-3/16" x 12-3/16"	8.50	1	CAD-PL1212	\$300.25	CAD-PLSS1212	\$937.50
12" x 24"	12-3/16" x 24-3/16"	15.00	2	CAD-PL1224	\$358.50	CAD-PLSS1224	\$1,120.00
18" x 18"	18-3/16" x 18-3/16"	15.00	2	CAD-PL1818	\$358.50	CAD-PLSS1818	\$1,120.00
24" x 24"	24-3/16" x 24-3/16"	23.00	4	CAD-PL2424	\$447.00	CAD-PLSS2424	\$1,396.50
24" x 36"	24-3/16" x 36-3/16"	27.00	5	CAD-PL2436	\$512.00	CAD-PLSS2436	\$1,597.25

**NOTE:** The hinge is always furnished on the "A" or height (longer) dimension, unless otherwise specified.

**SERIES CAD-FL CEILING OR WALL ACCESS DOOR, FLUSH DOOR WITH FRAME**

**DESCRIPTION**

The MIFAB® CAD-FL access door is designed for flush installation in drywall or plaster surfaces. The door panel is flush with the frame. When installed flush with the wall or ceiling, only the door panel is exposed. A mounting bracket is recessed 5/8" (15) from the door. It has a light color finish.

**SPECIFICATIONS**

**Material:** CAD-FL Series is a 16 gauge satin coat door and a 16 gauge satin coat frame. The CAD-FLSS Stainless Steel Series is 16 gauge #304 stainless steel door and frame.  
**Finish:** Satin coat steel doors have a primed finish. Stainless steel doors have a #4 brush satin finish.  
**Door:** Flush to frame. Turned back around edges for extra rigidity.  
**Frame:** Flush to surface. Mounting flange is 1 1/8" (28) wide and recessed 5/8" (15) from the door.  
**Hinge:** Concealed pivot pins.  
**Latch:** Standard – Flush mounted, screwdriver operated cam. Optional – Allen key, cylinder key, paddle latch, or Vandal resistant (lock only) (lock only) latch. All of MIFAB's cylinder key locks are keyed alike.  
**Packaging:** Individual pack.



CAD-FL / CAD-FL-PL OPTIONAL VARIATIONS		
SUFFIX	DESCRIPTION	LIST PRICE, EACH
-A	Allen key lock	\$29.25
-C	Cylinder key lock	\$36.75
-PL	Paddle latch	\$110.25
-VP	Vandal resistant (lock only)	\$110.25

**NOTE:** The hinge is always furnished on the "A" or height (longer) dimension, unless otherwise specified.

\* Custom sized access doors are available. Contact your local MIFAB® representative for a quotation for any size access door you need.

**SERIES CAD-FL-PL CEILING OR WALL ACCESS DOOR, FLUSH DOOR WITH FRAME, PLASTER FINISH**

**DESCRIPTION**

The MIFAB® CAD-FL-PL recessed access door is designed for flush installation in drywall or plaster surfaces. The door panel is flush with the frame. When installed flush with the wall or ceiling, only the door panel is exposed. A 2 3/4" (70) wide metal lath on all sides provides a rigid frame. A mounting bracket is recessed 5/8" (15) from the door. It has a light color finish.

**SPECIFICATIONS**

**Material:** CAD-FL-PL Series is a 16 gauge satin coat door and a 16 gauge satin coat frame. The CAD-FL-PLSS Stainless Steel Series is 16 gauge #304 stainless steel door and frame.  
**Finish:** Satin coat steel doors have a primed finish. Stainless steel doors have a #4 brush satin finish.  
**Door:** Flush to frame. Turned back around edges for extra rigidity.  
**Frame:** Mounting flange is 1 1/8" (28) wide and recessed 5/8" (15) from the door. A 2 3/4" (70) wide self furring metal lath lines the flange.  
**Hinge:** Concealed pivot pins.  
**Latch:** Standard – Flush mounted, screwdriver operated cam. Optional – Allen key, cylinder key, paddle latch, or Vandal resistant (lock only) (lock only) latch. All of MIFAB's cylinder key locks are keyed alike.  
**Packaging:** Individual pack.



"B" x "A"	WALL OPENING	SHIP WEIGHT (Lbs.)	LATCHES	MILD STEEL MODEL #	LIST PRICE MILD STEEL	STAINLESS STEEL MODEL #	LIST PRICE STAINLESS STEEL	MILD STEEL MODEL #	LIST PRICE MILD STEEL	STAINLESS STEEL MODEL #	LIST PRICE STAINLESS STEEL
8" x 8"	6-3/16" x 8-3/16"	4.0	1	CAD-FL0808	\$164.25	CAD-FLSS0808	\$515.25	CAD-FL-PL0808	\$209.50	CAD-FL-PLSS0808	\$657.75
8" x 12"	8-3/16" x 12-3/16"	5.0	1	CAD-FL0812	\$182.50	CAD-FLSS0812	\$564.75	CAD-FL-PL0812	\$226.75	CAD-FL-PLSS0812	\$705.25
10" x 10"	10-3/16" x 10-3/16"	5.5	1	CAD-FL1010	\$188.00	CAD-FLSS1010	\$546.50	CAD-FL-PL1010	\$217.00	CAD-FL-PLSS1010	\$688.00
12" x 12"	12-3/16" x 12-3/16"	6.0	1	CAD-FL1212	\$185.75	CAD-FLSS1212	\$580.00	CAD-FL-PL1212	\$229.00	CAD-FL-PLSS1212	\$721.50
12" x 16"	12-3/16" x 16-3/16"	7.0	1	CAD-FL1216	\$207.50	CAD-FLSS1216	\$643.75	CAD-FL-PL1216	\$251.50	CAD-FL-PLSS1216	\$786.25
12" x 18"	12-3/16" x 18-3/16"	8.0	1	CAD-FL1218	\$210.50	CAD-FLSS1218	\$663.00	CAD-FL-PL1218	\$259.25	CAD-FL-PLSS1218	\$807.75
12" x 24"	12-3/16" x 24-3/16"	11.4	3	CAD-FL1224	\$229.00	CAD-FLSS1224	\$720.25	CAD-FL-PL1224	\$275.50	CAD-FL-PLSS1224	\$859.75
14" x 14"	14-3/16" x 14-3/16"	7.8	1	CAD-FL1414	\$202.00	CAD-FLSS1414	\$627.50	CAD-FL-PL1414	\$246.25	CAD-FL-PLSS1414	\$771.00
16" x 16"	16-3/16" x 16-3/16"	9.6	1	CAD-FL1616	\$221.50	CAD-FLSS1616	\$689.00	CAD-FL-PL1616	\$264.50	CAD-FL-PLSS1616	\$832.75
16" x 20"	16-3/16" x 20-3/16"	11.4	1	CAD-FL1620	\$234.25	CAD-FLSS1620	\$732.25	CAD-FL-PL1620	\$277.50	CAD-FL-PLSS1620	\$874.75
18" x 18"	18-3/16" x 18-3/16"	11.4	3	CAD-FL1818	\$234.25	CAD-FLSS1818	\$731.25	CAD-FL-PL1818	\$277.50	CAD-FL-PLSS1818	\$874.75
18" x 24"	18-3/16" x 24-3/16"	15.0	3	CAD-FL1824	\$259.25	CAD-FLSS1824	\$812.25	CAD-FL-PL1824	\$303.50	CAD-FL-PLSS1824	\$955.75
20" x 24"	20-3/16" x 24-3/16"	17.0	3	CAD-FL2024	\$270.00	CAD-FLSS2024	\$845.50	CAD-FL-PL2024	\$316.50	CAD-FL-PLSS2024	\$985.00
20" x 30"	20-3/16" x 30-3/16"	19.0	5	CAD-FL2030	\$326.25	CAD-FLSS2030	\$1,026.00	CAD-FL-PL2030	\$372.50	CAD-FL-PLSS2030	\$1,166.50
24" x 24"	24-3/16" x 24-3/16"	18.3	3	CAD-FL2424	\$303.50	CAD-FLSS2424	\$957.00	CAD-FL-PL2424	\$350.00	CAD-FL-PLSS2424	\$1,098.25
24" x 30"	24-3/16" x 30-3/16"	20.0	5	CAD-FL2430	\$361.75	CAD-FLSS2430	\$1,124.25	CAD-FL-PL2430	\$406.00	CAD-FL-PLSS2430	\$1,266.75
24" x 36"	24-3/16" x 36-3/16"	24.5	5	CAD-FL2436	\$388.75	CAD-FLSS2436	\$990.25	CAD-FL-PL2436	\$434.25	CAD-FL-PLSS2436	\$1,362.00
30" x 30"	30-3/16" x 30-3/16"	24.5	5	CAD-FL3030	\$398.50	CAD-FLSS3030	\$1,243.00	CAD-FL-PL3030	\$445.00	CAD-FL-PLSS3030	\$1,389.00
36" x 36"	36-3/16" x 36-3/16"	28.0	5	CAD-FL3636	\$469.75	CAD-FLSS3636	\$1,463.50	CAD-FL-PL3636	\$513.00	CAD-FL-PLSS3636	\$1,606.00

Design and dimensions are subject to modification. Prices do not include applicable taxes. Visit [www.mifab.com](http://www.mifab.com) for the most recent product information.

**SERIES CAD-FR CEILING OR WALL ACCESS DOOR, FIRE RESISTANT**



**DESCRIPTION**

The MIFAB CAD-FR fire resistant access door is designed for use in a suspended drywall ceiling. The CAD-FR is not fire rated. However, the combination of steel and fire rated tile supplied by others may maintain the fire resistant quality of the ceiling assembly. The door panel is recessed 1 1/2" to accommodate dual layered ceiling tile. Consult local Fire Codes for each application.

**SPECIFICATIONS**

- Material:** CAD-FR Series is 16 gauge satin coat steel door and 16 gauge satin coat steel frame. The CAD-FRSS stainless steel Series is 16 gauge # 304 stainless steel door and frame.
- Finish:** Satin coat steel doors have a primed finish. Stainless steel doors have a #4 brush satin finish.
- Door:** Recessed 1 1/2" (38) door panel to accept tile, drywall or finishing materials.
- Frame:** Flush to surface. Mounting flange is 1 1/8" (28) wide and recessed 5/8" (16) from the door.
- Hinge:** Concealed pivot pins
- Latch:** Standard – Flush Mounted, screwdriver operated cam. Optional – Allen key, cylinder key, or Vandal resistant (lock only) latch. All of MIFAB's cylinder key locks are keyed alike.

**Packaging:** Individual pack.

CAD-FR OPTIONAL VARIATIONS		
SUFFIX	DESCRIPTION	LIST PRICE, EACH
-A	Allen key lock	<b>\$29.25</b>
-C	Cylinder key lock	<b>\$36.75</b>
-VP	Vandal resistant (lock only)	<b>\$110.25</b>

"B" x "A"	WALL OPENING	SHIP WEIGHT (Lbs.)	LATCHES	MILD STEEL MODEL #	LIST PRICE MILD STEEL	STAINLESS STEEL MODEL #	LIST PRICE STAINLESS STEEL
12" x 12"	12-3/16" x 12-3/16"	7.3	1	CAD-FR1212	<b>\$204.00</b>	CAD-FRSS1212	<b>\$649.00</b>
18" x 18"	18-3/16" x 18-3/16"	12.5	3	CAD-FR1818	<b>\$246.25</b>	CAD-FRSS1818	<b>\$742.00</b>
24" x 24"	24-3/16" x 24-3/16"	21.8	3	CAD-FR2424	<b>\$300.25</b>	CAD-FRSS2424	<b>\$955.75</b>
22" x 30"	22-3/16" x 30-3/16"	26.0	4	CAD-FR2230	<b>\$346.75</b>	CAD-FRSS2230	<b>\$1,103.75</b>

**NOTE:** The hinge is always furnished on the "A" or height (longer) dimension, unless otherwise specified.

**\* Custom sized access doors are available. Contact your local MIFAB® representative for a quotation for any size access door you need.**

**SERIES EA ECONOMY ACCESS DOOR**



**DESCRIPTION**

The MIFAB EA is a multi-purpose access door. It is designed for flush installation into drywall, block or tile walls and ceilings. Frame features rounded safety corners, concealed hinge, flush with frame fit, and a 3/8" turn back in the door panel for extra rigidity and safety.

**SPECIFICATIONS**

- Material:** EA Series is 20 gauge satin coat steel door and 20 gauge satin coat steel frame.
  - Finish:** EA doors are unfinished satin coat steel with no primer.
  - Door:** Flush to frame. Turned back around edges for extra rigidity.
  - Frame:** The frame has pre-punched mounting holes for simple installation and fold away tabs for drywall installation.
  - Hinge:** Concealed pivot pins.
  - Latch:** Standard – Flush mounted, screwdriver operated cam.
- Packaging:** Individual pack.

WALL OPENING SHIPPING	SHIP WEIGHT (Lbs.)	LATCHES	MILD STEEL MODEL #	LIST PRICE MILD STEEL
6 3/8" X 6 3/8"	1.50	1	EA0606	<b>\$22.75</b>
8 3/8" X 8 3/8"	1.90	1	EA0808	<b>\$23.75</b>
10 3/8" X 10 3/8"	2.60	1	EA1010	<b>\$28.00</b>
12 3/8" X 12 3/8"	3.30	1	EA1212	<b>\$29.25</b>
14 3/8" X 14 3/8"	4.20	1	EA1414	<b>\$50.75</b>
16 3/8" X 16 3/8"	5.10	1	EA1616	<b>\$53.00</b>
18 3/8" X 18 3/8"	6.20	1	EA1818	<b>\$62.50</b>
24 3/8" X 24 3/8"	9.80	1	EA2424	<b>\$103.75</b>

**NOTE:** The hinge is always furnished on the "A" or height (longer) dimension, unless otherwise specified.



**SERIES MPFR INSULATED FIRE RATED ACCESS DOOR**

**DESCRIPTION**

The MIFAB® MPFR fire rated access door is approved by Underwriters Laboratories Inc., for 1 1/2 hours, "B" label in walls and is approved by Warnock Hersey for 2 hours in ceilings and 3 hours in walls. The door meets ANSI-UL 10B standards. The same door can be used in walls and ceilings. Tests were conducted using mild steel and Type 304 stainless steel.

**SPECIFICATIONS**

**Material:** MPFR Series is 16 gauge satin coat steel front door with 20 gauge backliner and 16 gauge satin coat steel frame. The MPFRSS Stainless Steel Series is 16 gauge #304 stainless steel front door with 20 gauge backliner and 16 gauge #304 stainless steel frame.

**Finish:** Satin coat steel doors have a primed finish. Stainless steel doors have a #4 brush satin finish.

**Door:** Flush to frame. Self-closing. Can be opened from the inside or back of the door with MIFAB's unique thumb turn latch.

**Frame:** Four piece welded frame with masonry mounting straps.

**Hinge:** Concealed pivot pins.

**Spring:** Heavy duty. An extra spring is provided with every door greater than 14" x 14" (356 x 356) for ceiling installation. Both springs must be attached to the door to ensure that the door will close when installed in the ceiling.

**Latch:** Standard - Flush mounted, interchangeable turn ring operator and key operator latch. Optional - cylinder key lock. All of MIFAB's cylinder key locks are keyed alike.

**Fire Rating:** Underwriters Laboratories "B" label. 1 1/2 hours for walls. Warnock Hersey: 1 hour combustible ceilings and walls, 2 hour non-combustible ceilings, and 3 hour non-combustible walls. Ceiling fire ratings are up to and including the 24" x 36" (610 x 914) size.

**Insulation:** Roxul Rockboard 80. 2" (50) thick and fire retardant.

**Packaging:** Individual pack.



\* Custom sized access doors are available. Contact your local MIFAB® representative for a quotation for any size access door you need.

The access door construction design (lock and hinge) cannot be changed without affecting the Warnock Hersey and cUL approvals.

**Warnock Hersey**



California State Fire  
Marshall Approval  
#3330-1535:00

"B" x "A"	WALL OPENING	SHIP WEIGHT (Lbs.)	LATCHES	MILD STEEL MODEL #	LIST PRICE MILD STEEL	STAINLESS STEEL MODEL #	LIST PRICE STAINLESS STEEL
8" x 8"	8-1/2" x 8-1/2"	10.0	1	MPFR0808	\$253.75	MPFRSS0808	\$792.75
10" x 10"	10-1/2" x 10-1/2"	12.0	1	MPFR1010	\$315.25	MPFRSS1010	\$991.50
12" x 12"	12-1/2" x 12-1/2"	14.0	1	MPFR1212	\$291.75	MPFRSS1212	\$920.25
12" x 18"	12-1/2" x 18-1/2"	16.0	1	MPFR1218	\$364.00	MPFRSS1218	\$1,135.00
12" x 24"	12-1/2" x 24-1/2"	19.0	1	MPFR1224	\$456.75	MPFRSS1224	\$1,433.00
14" x 14"	14-1/2" x 14-1/2"	15.5	1	MPFR1414	\$337.00	MPFRSS1414	\$1,050.75
16" x 16"	16-1/2" x 16-1/2"	16.5	1	MPFR1616	\$343.50	MPFRSS1616	\$1,075.75
18" x 18"	18-1/2" x 18-1/2"	19.0	1	MPFR1818	\$354.25	MPFRSS1818	\$1,109.25
20" x 20"	20-1/2" x 20-1/2"	24.0	1	MPFR2020	\$477.50	MPFRSS2020	\$1,495.75
22" x 22"	22-1/2" x 22-1/2"	28.0	1	MPFR2222	\$513.00	MPFRSS2222	\$1,608.00
22" x 30"	22-1/2" x 30-1/2"	35.0	2	MPFR2230	\$513.00	MPFRSS2230	\$1,608.00
24" x 24"	24-1/2" x 24-1/2"	30.0	1	MPFR2424	\$410.50	MPFRSS2424	\$1,287.25
24" x 36"	24-1/2" x 36-1/2"	46.0	2	MPFR2436	\$734.50	MPFRSS2436	\$2,300.50
24" x 48"	24-1/2" x 48-1/2"	65.0	2	MPFR2448	\$840.25	MPFRSS2448	\$2,635.25
30" x 30"	30-1/2" x 30-1/2"	45.0	1	MPFR3030	\$715.00	MPFRSS3030	\$2,236.75
32" x 32"	32-1/2" x 32-1/2"	47.0	1	MPFR3232	\$1,026.00	MPFRSS3232	\$3,218.50
36" x 36"	36-1/2" x 36-1/2"	60.0	2	MPFR3636	\$1,130.75	MPFRSS3636	\$3,546.75
36" x 48"	36-1/2" x 48-1/2"	80.0	2	MPFR3648	\$1,518.50	MPFRSS3648	\$4,756.25

MPFR OPTIONAL VARIATIONS		
SUFFIX	DESCRIPTION	LIST PRICE, EACH
-C	Cylinder key lock	\$36.75

**Note:** The hinge is always furnished on the "A" or height (longer) dimension, unless otherwise specified.

**Note:** Custom sized MPFR Series of access doors cannot exceed 1,728 square inches with the fire rated approval.

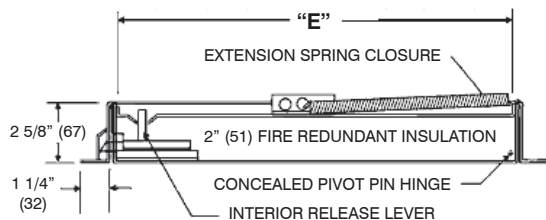

A-B Door Size C-D Overall Dimensions - Door Size - Plus 2 5/8" (67) E Wall Opening - Door Size - Plus 1/2" (13) (Allow an extra 1/4" (6) clearance for latch housing on "D" side.)

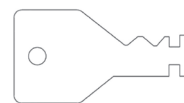

**Key Operator**

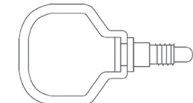

**Turn Ring Operator**

The Key Operator and Turn Ring Operator keys are shipped with every MPFR fire rated access door. If additional keys are required, please order them by Part # KEY-TRO

**SERIES MFRU UNINSULATED FIRE RATED ACCESS DOOR**



**DESCRIPTION**  
 The MIFAB® MFRU uninsulated fire rated access door is approved by Underwriters Laboratories Inc., for 1 1/2 hours, "B" label in walls. The door meets ANSI-UL 10B standards. It has a light color finish.

**SPECIFICATIONS**  
**Material:** MFRU Series is 16 gauge satin coat steel door and frame. The MFRUSS Stainless Steel Series is 16 gauge #304 stainless steel door and frame.  
**Finish:** Satin coat steel doors have a primed finish. Stainless steel doors have a #4 brush satin finish.  
**Door:** Flush to frame. Self-closing. Can be opened from the inside or back of the door with MIFAB's unique thumb turn latch.  
**Frame:** Four piece welded frame with masonry mounting straps.  
**Hinge:** Concealed pivot pins.  
**Spring:** Heavy duty.  
**Latch:** Standard - Flush mounted, interchangeable turn ring operator and key operator latch. Optional - cylinder key lock. All of MIFAB's cylinder key locks are keyed alike.  
**Fire Rating:** Underwriters Laboratories "B" label. 1 1/2 hour for walls. Insulation not required.  
**Packaging:** Individual pack.

\* Custom sized access doors are available. Contact your local MIFAB® representative for a quotation for any size access door you need.

"B" x "A"	WALL OPENING	SHIP WEIGHT (Lbs.)	LATCHES	MILD STEEL MODEL #	LIST PRICE MILD STEEL	STAINLESS STEEL MODEL #	LIST PRICE STAINLESS STEEL
8" x 8"	8-1/2" x 8-1/2"	9.0	1	MFRU0808	\$199.75	MFRUSS0808	\$833.75
10" x 10"	10-1/2" x 10-1/2"	10.0	1	MFRU1010	\$206.25	MFRUSS1010	\$641.50
12" x 12"	12-1/2" x 12-1/2"	12.5	1	MFRU1212	\$199.75	MFRUSS1212	\$618.75
12" x 18"	12-1/2" x 18-1/2"	14.5	1	MFRU1218	\$257.00	MFRUSS1218	\$806.75
12" x 24"	12-1/2" x 24-1/2"	17.0	1	MFRU1224	\$297.00	MFRUSS1224	\$926.50
14" x 14"	14-1/2" x 14-1/2"	14.0	1	MFRU1414	\$212.75	MFRUSS1414	\$667.50
16" x 16"	16-1/2" x 16-1/2"	15.0	1	MFRU1616	\$234.25	MFRUSS1616	\$730.00
18" x 18"	18-1/2" x 18-1/2"	17.0	1	MFRU1818	\$273.25	MFRUSS1818	\$857.50
20" x 20"	20-1/2" x 20-1/2"	21.5	1	MFRU2020	\$327.25	MFRUSS2020	\$1,027.00
22" x 22"	22-1/2" x 22-1/2"	25.0	1	MFRU2222	\$340.25	MFRUSS2222	\$1,066.00
22" x 30"	22-1/2" x 30-1/2"	31.5	1	MFRU2230	\$340.25	MFRUSS2230	\$1,066.00
24" x 24"	24-1/2" x 24-1/2"	27.0	1	MFRU2424	\$302.50	MFRUSS2424	\$949.25
24" x 36"	24-1/2" x 36-1/2"	41.5	2	MFRU2436	\$493.50	MFRUSS2436	\$1,540.00
24" x 48"	24-1/2" x 48-1/2"	58.5	2	MFRU2448	\$537.75	MFRUSS2448	\$1,686.00
30" x 30"	30-1/2" x 30-1/2"	40.5	2	MFRU3030	\$537.75	MFRUSS3030	\$1,686.00
32" x 32"	32-1/2" x 32-1/2"	42.5	2	MFRU3232	\$620.00	MFRUSS3232	\$1,937.50
36" x 36"	36-1/2" x 36-1/2"	54.0	2	MFRU3636	\$696.50	MFRUSS3636	\$2,179.50
36" x 48"	36-1/2" x 48-1/2"	72.5	2	MFRU3648	\$968.75	MFRUSS3648	\$3,034.75

The access door construction design (lock and hinge) cannot be changed without affecting the Warnock Hersey and cUL approvals.



California State Fire Marshall Approval #3330-1535:00

MFRU OPTIONAL VARIATIONS		
SUFFIX	DESCRIPTION	LIST PRICE, EACH
-C	Cylinder key lock	\$36.75

**Note:** The hinge is always furnished on the "A" or height (longer) dimension, unless otherwise specified.  
**Note:** Custom sized MFRU Series of access doors cannot exceed 1,728 square inches with the fire rated approval.

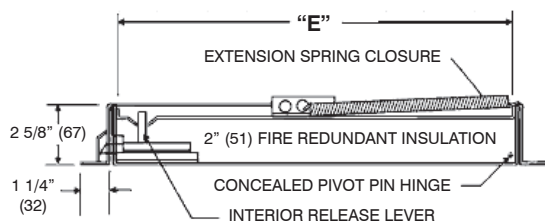

A-B Door Size C-D Overall Dimensions - Door Size - Plus 2 5/8" (67) E Wall Opening - Door Size - Plus 1/2" (13) (Allow an extra 1/4" (6) clearance for latch housing on "D" side.)

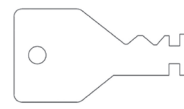

**Key Operator**

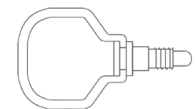

**Turn Ring Operator**

The Key Operator and Turn Ring Operator keys are shipped with every MFRU fire rated access door. If additional keys are required, please order them by Part # KEY-TRO

**SERIES MPFR-DW INSULATED FIRE RATED ACCESS DOOR WITH DRYWALL BEAD FRAME**

**DESCRIPTION**

The MIFAB® MPFR-DW fire rated access door is approved by Underwriters Laboratories Inc., for 1 1/2 hours, "B" label in walls and is approved by Warnock Hersey for 2 hours in ceilings and 3 hours in walls. It meets ANSI-UL 10B standards. The same door can be used in walls and ceilings. Tests were conducted using mild steel and Type 304 stainless steel. The MPFR-DW incorporates a drywall bead type of frame for a concealed frame application.

**SPECIFICATIONS**

**Material:** MPFR-DW Series is 16 gauge satin coat steel front door with 20 gauge backliner and 16 gauge satin coat steel frame. The MPFR-DWSS Stainless Steel Series is 16 gauge #304 stainless steel front door with 20 gauge backliner and 16 gauge #304 stainless steel frame.

**Finish:** Satin coat steel doors have a primed finish. Stainless steel doors have a #4 brush satin finish.

**Door:** Flush to frame. Self-closing. Can be opened from the inside or back of the door with MIFAB's unique thumb-turn latch.

**Frame:** Four piece welded frame with masonry mounting straps and drywall bead frame for concealed drywall applications.

**Hinge:** Concealed pivot pins.

**Spring:** Heavy duty. An extra spring is provided with every door greater than 14" x 14" (356 x 356) for ceiling installation. Both springs must be attached to the door to ensure that the door will close when installed in the ceiling.

**Latch:** Standard - Flush mounted, interchangeable turn-ring operator and key-operator latch. Optional - cylinder key lock. All of MIFAB's cylinder key locks are keyed alike.

**Fire Rating:** Underwriters Laboratories "B" label. 1 1/2 hours for walls. Warnock Hersey: 1 hour combustible ceilings and walls, 2 hour non-combustible ceilings and 3 hour noncombustible walls. Ceiling fire ratings are up to and including the 24" x 36" (610 x 914) size.

**Insulation:** Roxul Rockboard 80. 2" (50) thick and fire retardant.

**Packaging:** Individual pack.



\* Custom sized access doors are available. Contact your local MIFAB® representative for a quotation for any size access door you need.

The access door construction design (lock and hinge) cannot be changed without affecting the Warnock Hersey and cUL approvals.

**Warnock Hersey**



California State  
Fire Marshall  
Approval  
#3330-1535:00

"B" x "A"	WALL OPENING	SHIP WEIGHT (Lbs.)	LATCHES	MILD STEEL MODEL #	LIST PRICE MILD STEEL	STAINLESS STEEL MODEL #	LIST PRICE STAINLESS STEEL
8" x 8"	8-1/2" x 8-1/2"	10.0	1	MPFR-DW0808	\$285.25	MPFR-DWSS0808	\$825.25
10" x 10"	10-1/2" x 10-1/2"	12.0	1	MPFR-DW1010	\$346.75	MPFR-DWSS1010	\$1,022.75
12" x 12"	12-1/2" x 12-1/2"	14.0	1	MPFR-DW1212	\$325.00	MPFR-DWSS1212	\$952.50
12" x 18"	12-1/2" x 18-1/2"	16.0	1	MPFR-DW1218	\$394.25	MPFR-DWSS1218	\$1,165.25
12" x 24"	12-1/2" x 24-1/2"	19.0	1	MPFR-DW1224	\$488.00	MPFR-DWSS1224	\$1,464.50
14" x 14"	14-1/2" x 14-1/2"	15.5	1	MPFR-DW1414	\$366.00	MPFR-DWSS1414	\$1,085.50
16" x 16"	16-1/2" x 16-1/2"	16.5	1	MPFR-DW1616	\$374.75	MPFR-DWSS1616	\$1,109.25
18" x 18"	18-1/2" x 18-1/2"	19.0	1	MPFR-DW1818	\$385.50	MPFR-DWSS1818	\$1,141.50
20" x 20"	20-1/2" x 20-1/2"	24.0	1	MPFR-DW2020	\$508.75	MPFR-DWSS2020	\$1,529.25
22" x 22"	22-1/2" x 22-1/2"	28.0	1	MPFR-DW2222	\$545.50	MPFR-DWSS2222	\$1,640.50
22" x 30"	22-1/2" x 30-1/2"	35.0	2	MPFR-DW2230	\$545.50	MPFR-DWSS2230	\$1,640.50
24" x 24"	24-1/2" x 24-1/2"	30.0	1	MPFR-DW2424	\$440.50	MPFR-DWSS2424	\$1,318.75
24" x 36"	24-1/2" x 36-1/2"	46.0	2	MPFR-DW2436	\$764.50	MPFR-DWSS2436	\$2,332.75
24" x 48"	24-1/2" x 48-1/2"	65.0	2	MPFR-DW2448	\$873.75	MPFR-DWSS2448	\$2,668.75
30" x 30"	30-1/2" x 30-1/2"	45.0	1	MPFR-DW3030	\$745.25	MPFR-DWSS3030	\$2,269.00
32" x 32"	32-1/2" x 32-1/2"	47.0	1	MPFR-DW3232	\$1,058.50	MPFR-DWSS3232	\$3,252.00
36" x 36"	36-1/2" x 36-1/2"	60.0	2	MPFR-DW3636	\$1,161.00	MPFR-DWSS3636	\$3,580.25
36" x 48"	36-1/2" x 48-1/2"	80.0	2	MPFR-DW3648	\$1,547.50	MPFR-DWSS3648	\$4,789.75

**MPFR-DW OPTIONAL VARIATIONS**

SUFFIX	DESCRIPTION	LIST PRICE, EACH
-C	Cylinder key lock	\$36.75

**Note:** The hinge is always furnished on the "A" or height (longer) dimension, unless otherwise specified.

**Note:** Custom sized MPFR-DW Series of access doors cannot exceed 1,728 square inches with the fire rated approval.

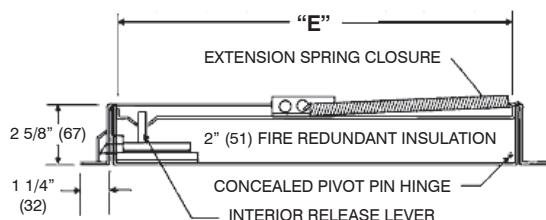

**Key Operator**

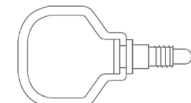

**Turn Ring Operator**

The Key Operator and Turn Ring Operator keys are shipped with every MPFR-DW fire rated access door. If additional keys are required, please order them by Part # KEY-TRO

A-B Door Size C-D Overall Dimensions - Door Size - Plus 2 5/8" (67) E Wall Opening - Door Size - Plus 1/2" (13) (Allow an extra 1/4" (6) clearance for latch housing on "D" side.)

**SERIES MI-SAD MEDIUM SECURITY ACCESS DOOR**



**DESCRIPTION**

The MIFAB® MI-SAD medium security access door is designed for drywall, masonry, or concrete construction, providing the security required in today's schools, hospitals, hotels, and correctional institutions. It has a light color finish.

**SPECIFICATIONS**

**Material:** MI-SAD Series is 12 gauge steel door and 3/16" angle steel frame. The MI-SADSS Stainless Steel Series is 12 gauge #304 stainless steel door and 3/16" (4) angle stainless steel frame.

**Finish:** Satin coat steel doors have a primed finish. Stainless steel doors have a #4 brush satin finish.

**Door:** Flush to frame.

**Frame:** 3/16" (4) x 1 1/2" (38) x 1 1/2" (38) angle steel, angle welded with joints ground smooth. The frame has pre-punched 3/16" (4) mounting holes for easy installation.

**Hinge:** Two heavy duty butt hinges welded to the door and frame.

**Latch:** Standard - Cylinder key lock. All of MIFAB's cylinder key locks are keyed alike.

**Packaging:** Individual pack.

**\* Custom sized access doors are available. Contact your local MIFAB® representative for a quotation for any size access door you need.**

"B" x "A"	WALL OPENING	SHIP WEIGHT (Lbs.)	LATCHES	MILD STEEL MODEL #	LIST PRICE MILD STEEL	STAINLESS STEEL MODEL #	LIST PRICE STAINLESS STEEL
8" x 8"	8-1/2" x 8-1/2"	10.0	1	MI-SAD0808	\$670.75	MI-SADSS0808	\$2,098.50
10" x 10"	10-1/2" x 10-1/2"	11.0	1	MI-SAD1010	\$712.75	MI-SADSS1010	\$2,237.75
12" x 12"	12-1/2" x 12-1/2"	17.0	1	MI-SAD1212	\$777.50	MI-SADSS1212	\$2,444.00
14" x 14"	14-1/2" x 14-1/2"	20.0	1	MI-SAD1414	\$892.00	MI-SADSS1414	\$2,794.00
16" x 16"	16-1/2" x 16-1/2"	24.0	1	MI-SAD1616	\$1,113.50	MI-SADSS1616	\$3,496.00
18" x 18"	18-1/2" x 18-1/2"	28.0	1	MI-SAD1818	\$1,224.75	MI-SADSS1818	\$3,841.50
18" x 24"	18-1/2" x 24-1/2"	34.0	1	MI-SAD1824	\$1,335.00	MI-SADSS1824	\$4,189.25
22" x 22"	22-1/2" x 22-1/2"	37.0	1	MI-SAD2222	\$1,560.50	MI-SADSS2222	\$4,892.50
24" x 24"	24-1/2" x 24-1/2"	41.0	1	MI-SAD2424	\$1,670.75	MI-SADSS2424	\$5,232.50
24" x 30"	24-1/2" x 30-1/2"	50.0	1	MI-SAD2430	\$1,783.00	MI-SADSS2430	\$5,589.00
24" x 36"	24-1/2" x 36-1/2"	56.0	2	MI-SAD2436	\$1,894.25	MI-SADSS2436	\$5,937.75
30" x 30"	30-1/2" x 30-1/2"	60.0	2	MI-SAD3030	\$2,115.75	MI-SADSS3030	\$6,632.25
36" x 36"	36-1/2" x 36-1/2"	75.0	2	MI-SAD3636	\$2,227.00	MI-SADSS3636	\$6,982.25

**SERIES MI-SADH HIGH SECURITY ACCESS DOOR**



**DESCRIPTION**

The MIFAB® MI-SADH high security access door is designed to provide security access, with the strength and durability to endure abusive and vandal-prone conditions, common in many institutions. It has a light color finish.

**SPECIFICATIONS**

**Material:** MI-SADH Series is 10 gauge steel door and 1/4" angle steel frame. The MI-SADHSS Stainless Steel Series is 10 gauge #304 stainless steel door and 1/4" (6) angle stainless steel frame.

**Finish:** Steel doors have a primed finish. Stainless steel doors have a #4 brush satin finish.

**Door:** Flush to frame.

**Frame:** 1/4" x 2" x 2" (6 x 50 x 50) angle steel, angle welded with joints ground smooth. The frame has pre-punched 1/4" (6) mounting holes for easy installation.

**Hinge:** Two heavy duty butt hinges welded to the door and frame.

**Latch:** Standard - Best Lock #1E7D4-C228-RP3-626 with key. Optional - locks provided by others.

**Packaging:** Individual pack.

**\* Custom sized access doors are available. Contact your local MIFAB® representative for a quotation for any size access door you need.**

"B" x "A"	WALL OPENING	SHIP WEIGHT (Lbs.)	LATCHES	MILD STEEL MODEL #	LIST PRICE MILD STEEL	STAINLESS STEEL MODEL #	LIST PRICE STAINLESS STEEL
12" x 12"	12-1/2" x 12-1/2"	22.0	1	MI-SADH1212	\$1,559.50	MI-SADHSS1212	\$4,891.25
16" x 16"	16-1/2" x 16-1/2"	31.0	1	MI-SADH1616	\$1,670.75	MI-SADHSS1616	\$5,234.75
18" x 18"	18-1/2" x 18-1/2"	37.0	1	MI-SADH1818	\$1,678.25	MI-SADHSS1818	\$5,245.50
24" x 24"	24-1/2" x 24-1/2"	55.0	1	MI-SADH2424	\$2,127.50	MI-SADHSS2424	\$6,669.00
24" x 36"	24-1/2" x 36-1/2"	73.0	2	MI-SADH2436	\$2,532.50	MI-SADHSS2436	\$7,938.00
24" x 48"	24-1/2" x 48-1/2"	88.0	2	MI-SADH2448	\$2,834.00	MI-SADHSS2448	\$8,505.00
36" x 36"	36-1/2" x 36-1/2"	97.0	2	MI-SADH3636	\$3,036.00	MI-SADHSS3636	\$9,522.25
36" x 48"	36-1/2" x 48-1/2"	120.0	2	MI-SADH3648	\$4,473.25	MI-SADHSS3648	\$12,822.75



**SERIES MI-FVP**

**FLUSH VALVE PANEL**

**DESCRIPTION**

The MIFAB® MI-FVP flush valve panel is designed for back supply toilets and urinals where the flush valve is built into the wall. This panel allows easy access to service the flush valve by maintenance personnel. The panel provides protection to the flush valve from vandalism.

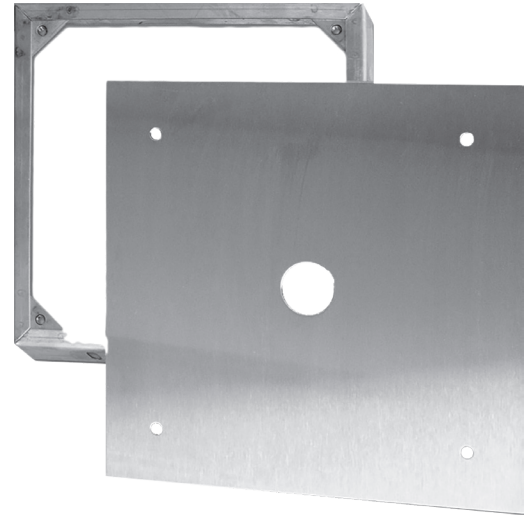

**SPECIFICATIONS**

**Material:** MI-FVP Series is 16 gauge satin coat steel door and 16 gauge satin coat steel frame. The MI-FVPSS Stainless Steel Series is 16 gauge #304 stainless steel door and frame.

**Finish:** Steel doors have a primed finish. Stainless steel doors have a #4 brush satin finish.

**Door:** Has a 1 1/2" (38) diameter hole in the center of the panel for the flush valve push button. Optional - solid door with no hole in the middle - Suffix "-NH".

**Frame:** Two piece construction with 5/16" x 11/16" (8 x 17.5) OBL Slots for easy installation.

**Latch:** Four 1/4" (6) - 20 x 1" (25) tamper resistant stainless steel Torx screws.

**Packaging:** Individual pack.

\* Custom sized access doors are available. Contact your local MIFAB® representative for a quotation for any size access door you need.

"B" x "A"	DOOR SIZE	WALL OPENING	SHIPPING WEIGHT (Lbs.)	MILD STEEL MODEL #	LIST PRICE MILD STEEL	STAINLESS STEEL MODEL #	LIST PRICE STAINLESS STEEL
MI-FVP-1	12" x 12"	10-1/2" x 10-1/2"	6.00	MI-FVP1212	\$234.25	MI-FVPSS1212	\$731.00
MI-FPV-2	13" x 17"	11-1/2" x 15-1/2"	7.00	MI-FVP1317	\$313.25	MI-FVPSS1317	\$980.50

**SERIES MI-SF**

**SURFACE ACCESS DOOR**

**DESCRIPTION**

The MIFAB® MI-SF surface access door is designed for surface installation on drywall, masonry, or thin-coat plaster. The door is attached to the frame with a continuous piano hinge allowing 175 degree opening. It has a light color finish.



**SPECIFICATIONS**

**Material:** MI-SF Series is 16 gauge steel door and frame. The MI-SFSS Stainless Steel Series is 16 gauge #304 stainless steel door and frame.

**Finish:** Satin coat steel doors have a primed finish. Stainless steel doors have a #4 brush satin finish.

**Door:** Flush to frame. One 1/4" (6) hole in each corner. A 3/8" (9) wide outer perimeter space of the frame is bent on a fifteen degree angle toward the wall.

**Hinge:** Continuous piano hinge. 175 degree opening.

**Latch:** Standard - Flush mounted, screwdriver operated cam. Optional - Allen key, cylinder key, or Vandal resistant (lock only) (lock only) latch. All of MIFAB's cylinder key locks are keyed alike.

**Packaging:** Individual pack.

\* Custom sized access doors are available. Contact your local MIFAB® representative for a quotation for any size access door you need.

"B" x "A"	SHIP WEIGHT (Lbs.)	LATCHES	MILD STEEL MODEL #	LIST PRICE MILD STEEL	STAINLESS STEEL MODEL #	LIST PRICE STAINLESS STEEL
8" x 8"	2.5	1	MI-SF0808	\$87.50	MI-SFSS0808	\$271.00
10" x 10"	3.5	1	MI-SF1010	\$95.00	MI-SFSS1010	\$298.00
12" x 12"	4.0	1	MI-SF1212	\$107.00	MI-SFSS1212	\$327.25
14" x 14"	6.0	1	MI-SF1414	\$120.00	MI-SFSS1414	\$370.50
16" x 16"	8.0	1	MI-SF1616	\$136.00	MI-SFSS1616	\$424.50
18" x 18"	9.5	3	MI-SF1818	\$148.00	MI-SFSS1818	\$460.00
22" x 22"	13.5	3	MI-SF2222	\$179.25	MI-SFSS2222	\$562.75
24" x 24"	16.0	3	MI-SF2424	\$209.50	MI-SFSS2424	\$658.75

MI-SF OPTIONAL VARIATIONS		
SUFFIX	DESCRIPTION	LIST PRICE, EACH
-A	Allen key lock	\$29.25
-C	Cylinder key lock	\$36.75
-VP	Vandal resistant (lock only)	\$110.25

**NOTE:** The hinge is always furnished on the "A" or height (longer) dimension, unless otherwise specified.



**SERIES MI-VB, MI-VB-SM VALVE BOX**

**DESCRIPTION**  
 The MIFAB® MI-VB valve box is designed to provide easy access to all types of valves and controls that are concealed in the wall and need to be protected by a fully enclosed box. The MIFAB® MI-VB-SM valve box is designed to provide easy access to all types of valves and controls that extend outside of the finished wall and need to be protected by a fully enclosed box. The depth of all valve boxes can be customized to meet any rough in requirements.

**SPECIFICATIONS**  
**Material:** MI-VB Series is a 16 gauge satin coat steel door and frame and a 20 gauge satin coat steel box. The MI-VB-SM is 16 gauge satin coat steel door and box. The MI-VBSS is a 16 gauge #304 stainless steel door and frame with a 20 gauge #304 stainless steel box. The MI-VB-SMSS is a 16 gauge #304 stainless steel door and box.

**Finish:** All Satin Coat VB's have a primed finish. MI-VBSS has a #4 brush satin finish on door and frame and a 2B finish on the box. MI-VB-SMSS has a #4 brush satin finish on door as well as the box.

**Door:** MI-VB Series - flush to frame. Turned back around edges for extra rigidity. MI-VB-SM Series - overlaps box, providing a tight secure fit. Optional - opening cut out of door to allow for glass or plastic window to be installed - window material supplied by others.

**Frame:** MI-VB Series - pre-punched mounting holes for simple installation. It is welded to the box.

**Hinge:** Concealed pivot pins.

**Latch:** Standard - Flush mounted, screwdriver operated cam. Optional - Allen key, cylinder key, or paddle latch. All of MIFAB's cylinder key locks are keyed alike.

**Packaging:** Individual pack.



MI-VB-SM with optional cut out of door to allow for glass or plastic window by others.

**(Illustrated) (Suffix -CO)**  
**\$261.25, List Price**

MI-VB, MI-VB-SM OPTIONAL VARIATIONS		
SUFFIX	DESCRIPTION	LIST PRICE, EACH
-A	Allen key lock	\$29.25
-C	Cylinder key lock	\$36.75
-CO	Cut out in middle of door	\$261.25
-PL	Paddle latch	\$110.25
-VP	Vandal resistant (lock only)	\$110.25
-WR	Water resistant	\$176.00

**NOTE:** The hinge is always furnished on the "A" or height (longer) dimension, unless otherwise specified.

\* Custom sized access doors are available. Contact your local MIFAB® representative for a quotation for any size access door you need.

MI-VB SERIES (RECESSED)							
"B" x "A"	DOOR SIZE	SHIPPING WEIGHT (Lbs.)	LATCHES	MILD STEEL MODEL #	LIST PRICE MILD STEEL	STAINLESS STEEL MODEL #	LIST PRICE STAINLESS STEEL
8" x 8" x 4"	8" x 8" x 4"	10.0	1	MI-VB080804	\$323.00	MI-VBSS080804	\$1,012.00
8" x 8" x 6"	8" x 8" x 6"	12.0	1	MI-VB080806	\$346.75	MI-VBSS080806	\$1,084.25
8" x 8" x 8"	8" x 8" x 8"	14.0	1	MI-VB080808	\$379.00	MI-VBSS080808	\$1,184.75
12" x 12" x 4"	12" x 12" x 4"	18.0	1	MI-VB121204	\$401.75	MI-VBSS121204	\$1,260.25
12" x 12" x 6"	12" x 12" x 6"	20.0	1	MI-VB121206	\$426.50	MI-VBSS121206	\$1,332.75
12" x 12" x 8"	12" x 12" x 8"	24.0	1	MI-VB121208	\$447.00	MI-VBSS121208	\$1,397.50
14" x 14" x 4"	14" x 14" x 4"	26.0	1	MI-VB141404	\$502.25	MI-VBSS141404	\$1,572.50
14" x 14" x 6"	14" x 14" x 6"	28.0	1	MI-VB141406	\$523.75	MI-VBSS141406	\$1,639.50
14" x 14" x 8"	14" x 14" x 8"	30.0	1	MI-VB141408	\$559.50	MI-VBSS141408	\$1,748.50
16" x 16" x 4"	16" x 16" x 4"	32.0	1	MI-VB161604	\$523.75	MI-VBSS161604	\$1,639.50
16" x 16" x 6"	16" x 16" x 6"	34.0	1	MI-VB161606	\$559.50	MI-VBSS161606	\$1,748.50
16" x 16" x 8"	16" x 16" x 8"	36.0	1	MI-VB161608	\$593.00	MI-VBSS161608	\$1,818.75

MI-VB-SM SERIES (SURFACE MOUNTED)							
"B" x "A"	DOOR SIZE	SHIPPING WEIGHT (Lbs.)	LATCHES	MILD STEEL MODEL #	LIST PRICE MILD STEEL	STAINLESS STEEL MODEL #	LIST PRICE STAINLESS STEEL
8" x 8" x 4"	8" x 8" x 4"	10.0	1	MI-VB-SM080804	\$323.00	MI-VB-SMSS080804	\$1,012.00
8" x 8" x 6"	8" x 8" x 6"	12.0	1	MI-VB-SM080806	\$346.75	MI-VB-SMSS080806	\$1,084.25
8" x 8" x 8"	8" x 8" x 8"	14.0	1	MI-VB-SM080808	\$379.00	MI-VB-SMSS080808	\$1,184.75
12" x 12" x 4"	12" x 12" x 4"	18.0	1	MI-VB-SM121204	\$401.75	MI-VB-SMSS121204	\$1,260.25
12" x 12" x 6"	12" x 12" x 6"	20.0	1	MI-VB-SM121206	\$426.50	MI-VB-SMSS121206	\$1,332.75
12" x 12" x 8"	12" x 12" x 8"	24.0	1	MI-VB-SM121208	\$447.00	MI-VB-SMSS121208	\$1,397.50
14" x 14" x 4"	14" x 14" x 4"	26.0	1	MI-VB-SM141404	\$502.25	MI-VB-SMSS141404	\$1,572.50
14" x 14" x 6"	14" x 14" x 6"	28.0	1	MI-VB-SM141406	\$523.75	MI-VB-SMSS141406	\$1,639.50
14" x 14" x 8"	14" x 14" x 8"	30.0	1	MI-VB-SM141408	\$559.50	MI-VB-SMSS141408	\$1,748.50
16" x 16" x 4"	16" x 16" x 4"	32.0	1	MI-VB-SM161604	\$523.75	MI-VB-SMSS161604	\$1,639.50
16" x 16" x 6"	16" x 16" x 6"	34.0	1	MI-VB-SM161606	\$559.50	MI-VB-SMSS161606	\$1,748.50
16" x 16" x 8"	16" x 16" x 8"	36.0	1	MI-VB-SM161608	\$593.00	MI-VB-SMSS161608	\$1,818.75

**SERIES PA**
**PLASTIC ACCESS DOOR**
**DESCRIPTION**

The MIFAB® PA plastic access door is designed to provide easy access to plumbing and cables behind walls and ceilings. The door is removable from the frame and fits tightly with snap latches. The white finish can be painted or wallpapered or left as is to match the surrounding environment. This door should not be installed near any existing or potential source of excessive heat or open flame.

**SPECIFICATIONS**

**Material:** PA Series is made of 1/8" (3) thick high impact styrene plastic with U.V. stabilizers to prevent fading and corrosion.  
**Finish:** Light color.  
**Door:** Flush to frame - rounded safety corners. Two pull tabs on the back of the door allow door to be pulled back into the frame from behind walls and ceilings.  
**Frame:** One piece outside flange that is 1 1/2" (38) wide with a 5/8" deep mounting flange.  
**Latch:** Snap latches allow door to fit tightly into frame.  
**Packaging:** 8" x 8" (203 x 203) and 14" x 14" (356 x 356) doors are packed 15 per carton and the 14" x 29" (356 x 736) doors are packed 5 per carton.



MODEL #	PA SERIES	WALL OPENING	SHIPPING WEIGHT (Lbs.) (UNIT)	SHIPPING WEIGHT (Lbs.) (CARTON)	LIST PRICE, EACH
PA0808	8" x 8"	7-7/8" x 7-7/8"	0.75	14.00	\$28.00
PA1414	14" x 14"	13-7/8" x 13-7/8"	1.75	30.00	\$37.75
PA1429	14" x 29"	13-7/8" x 28-7/8"	2.90	17.00	\$73.50

**SERIES FHA, FHG**
**FLOOR ACCESS DOOR**
**DESCRIPTION**

The MIFAB Series FHA and FHG floor access doors are for interior and exterior use where easy access is required. The angle frame construction with integral anchor flange is designed to be cast into concrete. They are available in either an acid resistant, powder epoxy coated steel finish (grey color) (FHG) or aluminum (FHA). Standard units withstand load bearing of 300 lbs. per square foot. They are designed for safety, durability and ease of operation.

**SPECIFICATIONS**

**Material:** FHG Series has a door made of 3/16" (5 mm) thick A36 diamond plate. FHA Series has a door made of 3/16" (5) thick structural grade aluminum diamond plate. Both doors can support 300 lbs. per square foot live load. Frame material is composite hot rolled steel angle frame.  
**Finish:** FHG Series has an acid resistant, powder epoxy coated grey finish. FHA Series is an aluminum mill finish. Frame is finished with a bituminous coating.  
**Door:** Flush to frame. Equipped with an automatically locking hold open arm that locks the door in the open position. Also available are 1/4" (6 mm) thick doors reinforced to meet a 10,000 lb. load rating. (without impact for the FHA Series)  
**Frame:** Complete with a 1" (25 mm) anchor flange. All hardware is Type # 316 stainless steel.  
**Hinge:** Tamper proof steel hinges with stainless steel pins.  
**Opening Device:** Automatic locking hold open arm with red vinyl grip allows door to open 90 degrees.  
**Handle:** Stainless steel recessed lift handle in the door.  
**Latch:** The following lock options are available: padlock staple, Type # 316 stainless steel snap lock with removable handle, recessed hasp, Type # 316 stainless steel pentahead, keyed deadbolt lock or hasp and staple. The standard latch used is the compression lever latch (illustrated below).  
**Packaging:** Individual pack.

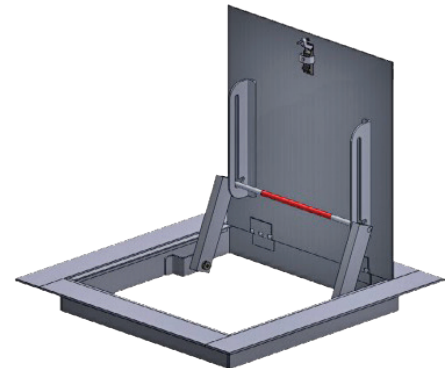

"B" x "A"	FLOOR OPENING	FHA SHIPPING WT. (Lbs.)	FHG SHIPPING WT. (Lbs.)	FHG MODEL #	FHG LIST PRICE	ALUMINUM MODEL #	FHA LIST PRICE (ALUMINUM)
24" x 24"	26-1/2" x 24-1/2"	42.0	90.0	FHG2424	\$1,732.25	FHA2424	\$2,113.50
24" x 30"	26-1/2" x 30-1/2"	49.0	105.0	FHG2430	\$1,991.50	FHA2430	\$2,440.75
24" x 36"	26-1/2" x 36-1/2"	55.0	120.0	FHG2436	\$2,094.00	FHA2436	\$2,782.00
30" x 30"	32-1/2" x 30-1/2"	56.0	122.0	FHG3030	\$2,367.25	FHA3030	\$4,447.50
30" x 36"	32-1/2" x 36-1/2"	64.0	138.0	FHG3036	\$2,431.00	FHA3036	\$4,731.50
30" x 48"	32-1/2" x 48-1/2"	78.0	172.0	FHG3048	\$3,094.25	FHA3048	\$5,221.75
36" x 36"	38-1/2" x 36-1/2"	72.0	156.0	FHG3636	\$3,283.25	FHA3636	\$5,578.25
36" x 48"	38-1/2" x 48-1/2"	89.0	194.0	FHG3648	\$3,579.00	FHA3648	\$6,114.00
42" x 42"	44-1/2" x 42-1/2"	90.0	196.0	FHG4242	\$3,439.75	FHA4242	\$5,661.25
48" x 48"	50-1/2" x 48-1/2"	108.0	240.0	FHG4848	\$4,255.25	FHA4848	\$6,094.50
48" x 72"	50-1/2" x 72-1/2"	150.0	332.0	FHG4872	\$7,043.75	FHA4872	\$8,971.50
60" x 60"	62-1/2" x 60-1/2"	155.0	340.0	FHG6060	\$8,689.75	FHA6060	\$10,674.75

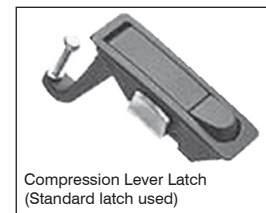
**Optional Accessories:**

- Compression Spring Assist
- Skirting to Depth of Slab
- Fibreglass Insulation

To determine the floor opening for doors with a Recess Frame (Suffix -RF), add 6" to the "B" x "A" (Door Opening) dimensions in the above chart. (Dimension) Denotes Millimetres. Note: The hinge is always furnished on the "A" or height (longer) dimension, unless otherwise specified. Example: the model number would be FHG4872 for a floor access door with the hinge on the longer (72") dimension. The model number would be FHG7248 for a floor access door with the hinge on the shorter (48") dimension.

Design and dimensions are subject to modification. Prices do not include applicable taxes. Visit [www.mifab.com](http://www.mifab.com) for the most recent product information.

**SERIES RHA, RHG ROOF HATCH**

**Note:** MIFAB can supply mounting points for any additional accessories.

**DESCRIPTION**

The MIFAB Series RHA and RHG roof hatches are designed to provide convenient, economical access to the roofs of buildings. They are available in either prime coated galvanized steel (RHG) or aluminum (RHA). All hatches are designed with weather resistant gasketing to ensure long life, low maintenance and ease of operation. Roof hatches install easily over the roof opening and are secured from the base flange to the roof deck.

**SPECIFICATIONS**

**Material:** RHG cover is 14 gauge galvanized steel and 20 gauge steel liner. RHA cover is .090" aluminum with a .050 aluminum liner. The inside of the cover is gasketed with a neoprene weather seal to provide a flush, tight, fit. Covers are insulated with 1" (25) of fibreboard and are designed to support a snow load of 40 lbs. per square foot. The frame for the RHG Series is 14 gauge galvanized steel and the frame for the RHA Series is .090" aluminum.

**Curb:** Curbs are 12" (305) high with 4" (102) wide rounded corner flashing flange complete with 1" (25) fibreboard insulation.

**Hinge:** Formed steel hinges with stainless steel pins.

**Finish:** RHG Series is a primed finish. RHA Series is an aluminum mill finish.

**Opening:** Hydraulic column operators allow cover to open and close easily.

**Device:** Cover is equipped with an automatic hold open arm with a red vinyl grip release that keeps the cover in an open position when needed, and allows for easy control when lowering the latch cover.

**Handle:** Self latching outside cadmium plated steel turn handle with inside lever handle allows cover to always latch securely.

**Latch:** Locking hasps are located both inside and outside of the cover. All hardware is cadmium plated steel.

"B" x "A"	INSIDE FRAME DIM.	OUTSIDE FRAME DIM.	ROOF OPENING	SHIPPING WEIGHT RHA (Lbs.)	SHIPPING WEIGHT RHG (Lbs.)	GALVANIZED MODEL #	RHG LIST PRICE (GALVANIZED)	ALUMINUM MODEL #	RHA LIST PRICE (ALUMINUM)
24" x 24"	24" x 24"	31" x 31"	24" x 24"	60.0	125.0	RHG2424	\$1,871.50	RHA2424	\$1,906.25
24" x 30"	24" x 30"	31" x 37"	24" x 30"	65.0	130.0	RHG2430	\$1,977.50	RHA2430	\$2,008.75
24" x 36"	24" x 36"	31" x 43"	24" x 36"	70.0	135.0	RHG2436	\$2,043.25	RHA2436	\$2,068.25
30" x 30"	30" x 30"	37" x 37"	30" x 30"	80.0	145.0	RHG3030	\$2,125.50	RHA3030	\$2,445.00
30" x 36"	30" x 36"	37" x 43"	30" x 36"	85.0	155.0	RHG3036	\$2,315.50	RHA3036	\$2,587.75
30" x 54"	30" x 54"	37" x 61"	30" x 54"	135.0	225.0	RHG3054	\$2,531.50	RHA3054	\$2,815.50
30" x 96"	30" x 96"	37" x 103"	30" x 96"	245.0	335.0	RHG3096	\$4,892.50	RHA3096	\$6,119.25
36" x 36"	36" x 36"	43" x 43"	36" x 36"	110.0	200.0	RHG3636	\$3,061.75	RHA3636	\$6,810.50
36" x 48"	36" x 48"	43" x 55"	36" x 48"	270.0	430.0	RHG3648	\$4,495.00	RHA3648	\$7,354.75
48" x 48"	48" x 48"	55" x 55"	48" x 48"	305.0	430.0	RHG4848	\$4,866.50	RHA4848	\$7,900.25

**LOCKS AND LATCHES**

**Mortise Prep Cylinder Lock** - (MIFAB can cut an opening into the door panel to accept any lock requested by the customer.

**Note:** illustration is with lock and key but this is always provided by others. **\$242.00** List Price, each. For the MPFR Series, the lock must be installed by MIFAB during the production process. (It cannot be installed later.)

(Part # 1E7D4-C228-RP3-626)

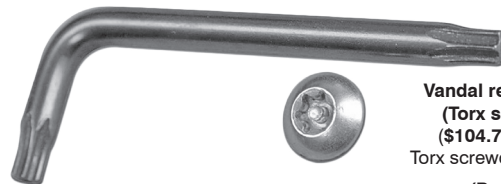

**Vandal resistant (lock only)**  
(Torx screw) (Suffix -VP)  
**(\$104.75** List Price, each)  
Torx screwdriver is not included.

(Part # H-1031B)  
(List Price - \$132.75)



**Allen Key Lock** (Suffix -A)  
**(\$29.25** List Price, each)  
(Part # ALLEN-LOCK)



**Flat Head Screw Driver Operated Cam Latch** (Standard)  
(Part # SCREW-DRIVER-LOCK)

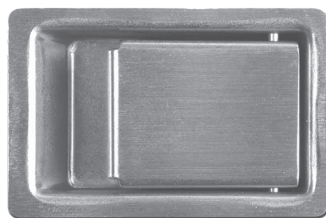

**Paddle Latch**  
(Suffix -PL)  
**(\$110.25** List Price, each)  
(Part # PADDLE-LATCH)

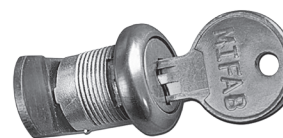

**Cylinder Lock and Key**  
(Suffix -C)  
(All of MIFAB's cylinder key locks are keyed alike)  
**(\$36.75** List Price, each)  
(Part # for the key only is CYL-KEY. List Price for the key only is **\$23.75**)

**SERIES WID**
**EXTERIOR ACCESS DOOR/WALK-IN DOOR**
**WID Series with 1" Insulation Thickness**

"B" x "A"	SHIPPING WEIGHT (Lbs.)	LATCHES	GALVANIZED MODEL #	GALVANIZED LIST PRICE	STAINLESS MODEL #	STAINLESS LIST PRICE	INSULATION THICKNESS
12" x 12"	15.00	1	WID1.0-1212	\$348.75	WIDSS1.0-1212	\$1,047.50	1"
12" x 24"	23.00	2	WID1.0-1224	\$453.50	WIDSS1.0-1224	\$1,360.75	1"
14" x 14"	17.00	1	WID1.0-1414	\$379.00	WIDSS1.0-1414	\$1,135.00	1"
16" x 16"	18.50	1	WID1.0-1616	\$415.75	WIDSS1.0-1616	\$1,247.50	1"
16" x 20"	20.00	1	WID1.0-1620	\$453.50	WIDSS1.0-1620	\$1,360.75	1"
16" x 36"	32.00	1	WID1.0-1636	\$811.00	WIDSS1.0-1636	\$2,025.00	1"
18" x 18"	20.00	1	WID1.0-1818	\$453.50	WIDSS1.0-1818	\$1,360.75	1"
20" x 30"	31.00	2	WID1.0-2030	\$811.00	WIDSS1.0-2030	\$2,022.75	1"
22" x 30"	32.00	2	WID1.0-2230	\$811.00	WIDSS1.0-2230	\$2,022.75	1"
22" x 36"	36.00	2	WID1.0-2236	\$857.50	WIDSS1.0-2236	\$2,145.00	1"
24" x 24"	28.00	1	WID1.0-2424	\$640.50	WIDSS1.0-2424	\$1,600.50	1"
24" x 36"	40.00	2	WID1.0-2436	\$960.00	WIDSS1.0-2436	\$2,105.00	1"
30" x 30"	38.00	2	WID1.0-3030	\$936.25	WIDSS1.0-3030	\$2,096.25	1"
30" x 60"	85.00	2	WID1.0-3060	\$1,431.00	WIDSS1.0-3060	\$2,859.75	1"
36" x 36"	50.00	2	WID1.0-3636	\$1,224.75	WIDSS1.0-3636	\$2,422.50	1"
36" x 48"	81.00	2	WID1.0-3648	\$1,423.50	WIDSS1.0-3648	\$2,607.00	1"

**WID Series with 1 1/2" Insulation Thickness**

"B" x "A"	SHIPPING WEIGHT (Lbs.)	LATCHES	GALVANIZED MODEL #	GALVANIZED LIST PRICE	STAINLESS MODEL #	STAINLESS LIST PRICE	INSULATION THICKNESS
12" x 12"	17.00	1	WID1.5-1212	\$420.00	WIDSS1.5-1212	\$1,257.00	1 1/2"
12" x 24"	25.00	2	WID1.5-1224	\$543.25	WIDSS1.5-1224	\$1,633.00	1 1/2"
14" x 14"	19.00	1	WID1.5-1414	\$453.50	WIDSS1.5-1414	\$1,362.00	1 1/2"
16" x 16"	20.00	1	WID1.5-1616	\$499.00	WIDSS1.5-1616	\$1,498.00	1 1/2"
16" x 20"	22.00	1	WID1.5-1620	\$543.25	WIDSS1.5-1620	\$1,633.00	1 1/2"
16" x 36"	35.00	1	WID1.5-1636	\$973.00	WIDSS1.5-1636	\$2,430.00	1 1/2"
18" x 18"	22.00	1	WID1.5-1818	\$543.25	WIDSS1.5-1818	\$1,633.00	1 1/2"
20" x 30"	34.00	2	WID1.5-2030	\$973.00	WIDSS1.5-2030	\$2,430.00	1 1/2"
22" x 30"	34.00	2	WID1.5-2230	\$973.00	WIDSS1.5-2230	\$2,430.00	1 1/2"
22" x 36"	40.00	2	WID1.5-2236	\$1,029.25	WIDSS1.5-2236	\$2,574.75	1 1/2"
24" x 24"	31.00	1	WID1.5-2424	\$769.00	WIDSS1.5-2424	\$1,920.25	1 1/2"
24" x 36"	44.00	2	WID1.5-2436	\$1,154.50	WIDSS1.5-2436	\$2,525.00	1 1/2"
30" x 30"	42.00	2	WID1.5-3030	\$1,123.25	WIDSS1.5-3030	\$2,516.50	1 1/2"
30" x 60"	90.00	2	WID1.5-3060	\$1,717.25	WIDSS1.5-3060	\$3,431.00	1 1/2"
36" x 36"	55.00	2	WID1.5-3636	\$1,467.75	WIDSS1.5-3636	\$2,906.25	1 1/2"
36" x 48"	90.00	2	WID1.5-3648	\$1,706.50	WIDSS1.5-3648	\$3,131.00	1 1/2"

**SERIES WID EXTERIOR ACCESS DOOR/WALK-IN DOOR**
**DESCRIPTION**

The MIFAB® WID exterior access doors are designed to provide convenient access to any exterior application, or anywhere that requires protection against air leakage and/or water penetration. WID doors are also designed to serve the custom air handling equipment manufacturers, as well as mechanical contractors who field assemble built-up air handling systems. All WID doors are manufactured using 10ga Galvanized Steel frames and 14ga Galvanized Steel door panels. WID doors are galvanized coated steel or optional stainless steel and aluminum. Door panels are insulated and gasketed. WID door can be manufactured in custom sizes from 12"x12" to 96"x96". Consult the factory for larger applications.

**SPECIFICATIONS**

**Flanged Frame:** 10ga. Galvanized Steel

**Door Panel:** 14ga. Galvanized Steel

**Insulation:** PCF fiberglass

**Handles:** Dual acting handles for inside and outside operation

**Gasket:** Extruded EPDM

**Hinge:** Zinc Plated Steel (Continuous)

**Finish:** Galvanized Coating

**Door Thickness:** 1", 1 1/2", 2"

**Size Range:** 12"x12" thru 96"x96"

**WID Series with 2" Insulation Thickness**

"B" x "A"	SHIPPING WEIGHT (Lbs.)	LATCHES	GALVANIZED MODEL #	GALVANIZED LIST PRICE	STAINLESS MODEL #	STAINLESS LIST PRICE	INSULATION THICKNESS
12" x 12"	19.00	1	WID2.0-1212	\$504.25	WIDSS2.0-1212	\$1,509.75	2"
12" x 24"	27.00	2	WID2.0-1224	\$653.50	WIDSS2.0-1224	\$1,959.00	2"
14" x 14"	21.00	1	WID2.0-1414	\$543.25	WIDSS2.0-1414	\$1,633.00	2"
16" x 16"	22.00	1	WID2.0-1616	\$598.25	WIDSS2.0-1616	\$1,795.00	2"
16" x 20"	24.00	1	WID2.0-1620	\$653.50	WIDSS2.0-1620	\$1,960.25	2"
16" x 36"	38.00	1	WID2.0-1636	\$1,169.50	WIDSS2.0-1636	\$2,919.25	2"
18" x 18"	24.00	1	WID2.0-1818	\$653.50	WIDSS2.0-1818	\$1,960.25	2"
20" x 30"	37.00	2	WID2.0-2030	\$1,168.50	WIDSS2.0-2030	\$2,919.25	2"
22" x 30"	37.00	2	WID2.0-2230	\$1,168.50	WIDSS2.0-2230	\$2,919.25	2"
22" x 36"	44.00	2	WID2.0-2236	\$1,237.75	WIDSS2.0-2236	\$3,088.75	2"
24" x 24"	34.00	1	WID2.0-2424	\$923.50	WIDSS2.0-2424	\$2,304.75	2"
24" x 36"	48.00	2	WID2.0-2436	\$1,382.50	WIDSS2.0-2436	\$3,029.50	2"
30" x 30"	45.00	2	WID2.0-3030	\$1,346.75	WIDSS2.0-3030	\$3,019.75	2"
30" x 60"	100.00	2	WID2.0-3060	\$2,060.75	WIDSS2.0-3060	\$4,119.00	2"
36" x 36"	60.00	2	WID2.0-3636	\$1,762.50	WIDSS2.0-3636	\$3,488.50	2"
36" x 48"	100.00	2	WID2.0-3648	\$2,048.75	WIDSS2.0-3648	\$3,757.25	2"



Acudor to MIFAB		
Acudor	MIFAB	Page #
ADWT	Contact MIFAB	-
AF-VP	MI-FVP	13
AP-5010	CAD-PL	6
ARVB	MI-VB	14
ASVB	MI-VB-SM	14
AS-9000	Contact MIFAB	-
AT-5020	CAD-FR	8
BP58	Contact MIFAB	-
DW-5015	CAD-DW	6
DW-5040	MDW	5
DW-5058	CAD	5
ED-2002	EA	8
FA-150, FA-300	FHA, FHG	15
FA-H20	FHA, FHG	15
FB-5060	MFRU	10
FB-5060-DW	MPFR-DW	11
FC-300	Contact MIFAB	-
FC-H20	Contact MIFAB	-
FD-8060	Contact MIFAB	-
FRFD	Contact MIFAB	-
FT-8040	Contact MIFAB	-
FT-8050	Contact MIFAB	-
FT-8060	Contact MIFAB	-
FT-8080	Contact MIFAB	-
FT-8080-1	Contact MIFAB	-
FW-5050	MPFR	9
FW-5050-DW	MPFR-DW	11
FW-5050-UP	Contact MIFAB	-
FW-5060-TD	Contact MIFAB	-
G3000, A3000	RHA, RHG	16
GFRG	Contact MIFAB	-
LT-4000	Contact MIFAB	-
MS-7000	MI-SAD	12
PA-3000	PA	15
PS-5030	CAD-FL-PL	7
SD-6000	MI-SADH	12
SF-2000	MI-SF	13
UF-5000	UA	4
UF-5500	UA	4
WD-8000	WID	17
Babcock - Davis to MIFAB		
Babcock -	MIFAB	Page #
Davis		
B-DTK	Contact MIFAB	-
B-FDDH	Contact MIFAB	-
B-FDDP	Contact MIFAB	-
B-FDE	FHG	15
F-FDN	FHA	15
B-FDR	Contact MIFAB	-
B-FRD	Contact MIFAB	-
B-FRV	Contact MIFAB	-
B-HS	MI-SADH	12
B-IP	MPFR-PL	9
B-IT	MPFR	9
B-IW	MPFR-DW	11
B-LW	UA	4
B-MP	MI-SAD-PL	12
B-MT	MI-SAD	12
B-MW	MI-SAD-DW	12
B-NP	CAD-FL-PL	7
B-NT	UA	4
B-NW	MDW	5
B-PL	PA	15
B-RA	CAD	5
B-RHA, RHG	RHA, RHG	16
B-RHE	Contact MIFAB	-
B-RHL	Contact MIFAB	-
B-RHS	Contact MIFAB	-
B-RV	Contact MIFAB	-
B-RW	CAD-DW	6
B-RP	CAD-PL	6
B-ST	MPFR-C	9
B-SW	MPFR-C-DW	11
B-TS	MI-SADH	12
B-UP	MFRU-PL	10
B-UT	MFRU	10
B-UW	MFRU-DW	10
B-XT	WID	17
Cendrex to MIFAB		
Cendrex	MIFAB	Page #
AHA	CAD	5
AHA-GYP	CAD-DW	6
AHA-PLY	CAD-FL	7
AHD	UA	4
AHD-GYP	MDW	5
AHD-PLY	CAD-FL-PL	7
BTA, BTV	MI-VB	14

CTR	MI-SF	13
DRD	Contact MIFAB	-
GRG	Contact MIFAB	-
LHD	Contact MIFAB	-
LHD-180	Contact MIFAB	-
MDS	MI-SAD	12
PAL	Contact MIFAB	-
PFI	MPFR	9
PFI-GYP	MPFR-DW	11
PFI-PLY	MPFR-PL	9
PFN	MFRU	10
PFN-GYP	MFRU-DW	11
PFN-PLY	MFRU-PL	10
PFU	Contact MIFAB	-
PHS	MI-SADH	12
PPA	FHA	15
PPA-RE	Contact MIFAB	-
RMD	MI-SF	13
RPL	PA	15
SFM	MI-SF	13
TRH	RHG	16
Elmdor to MIFAB		
Elmdor	MIFAB	Page #
AP	CAD-PL	6
AT	CAD	5
CFR	CAD-FR	8
DW	UA	4
DWB	MDW	5
ED	WID	17
FR	MFRU	10
FRC	MPFR	9
ML	CAD-FL-PL	7
PW	CAD-FL	7
RAH	RHA, RHG	16
SF	MI-SF	13
SLA	MI-SADH	12
SLK	MI-SADH	12
S009 / S010	MI-FVP	13
VB	MI-VB	14
WSR	Contact MIFAB	-
JL to MIFAB		
JL	MIFAB	Page #
AAF	Contact MIFAB	-
AGF	Contact MIFAB	-
ATM	Contact MIFAB	-
CP	CAD-PL	6
CT	CAD	5
CTWB	CAD-DW	6
FD	MPFR	9
FDPW	MPFR-DW	11
FDSS	MPFR-SS	9
FDWB	MPFR-DW	11
FRC	CAD-FR	8
HGFD	MPFR	9
HSP	MI-SADH	12
PW	CAD-FL	7
PWE	CAD-FL-PL	7
RHA, RHG	RHA, RHG	16
SMT	MI-SF	13
SP	MI-SAD	12
TM	UA	4
TMS	UA-SS	4
WB	MDW	5
XPA	WID	17
XPA-PWE	WID	17
XPA-PWE	WID	17
XPS	WID	17
Karp to MIFAB		
Karp	MIFAB	Page #
DSB-123SD	MI-SADH	12
DSB-123SD-MS	MI-SAD	12
DSB-214SM	MI-SF	13
DSC-210	CAD	5
DSC-210-PL	CAD-PL	6
DSC-214M	UA	4
DSC-214-PL	CAD-FL-PL	7
HA	PA	15
KAFA	Contact MIFAB	-
KATR	CAD-FR	8
KDW	CAD-FL-PL	7
KFD-HD	FHA, FHG	15
KFD-SD	FHA, FHG	15
KRHA	RHA	16
KRHG	RHG	16
KRP-150FR	MPFR	9
KRP-250FR	MFRU	10
KRP-350FR	MPFR-DW	11
KRP-450FR	MPFR-DW	10

KRVB	MI-VB-SM	14
KSMB	MI-VB	14
KSTC	Contact MIFAB	-
KSTDW	Contact MIFAB	-
KSTE	Contact MIFAB	-
MC	UA	4
MX	WID	17
PF	UA	4
RDWPD	Contact MIFAB	-
RDW	CAD-DW	6
Larsen's to MIFAB		
Larsen's	MIFAB	Page #
L-APC	CAD-PL	6
L-CPA	CAD	5
L-DPFB	MPFR-C	9
L-DPH	MI-SADH	12
L-DPM	MI-SAD	12
L-DWC	MDW	5
L-DWR	CAD-DW	6
L-FRAP	MPFR	9
L-LCP	EA	8
L-MPG	UA	4
L-MPSS	UA-SS	4
L-PSS	CAD-FL-PL	7
L-XT	WID	17
VC	MI-VB	14
Milcor to MIFAB		
Milcor	MIFAB	Page #
AP (3206-)	CAD-PL	6
AT (3205-)	CAD	5
ATR (3204-)	CAD-FR	8
CF	Contact MIFAB	-
CT	Contact MIFAB	-
DW (3203-)	MDW	5
DWR	CAD-DW	6
FA, FC, FM	FHA, FHG	15
HS (3211-)	MI-SADH	12
K (3200-)	CAD-FL-PL	7
M (3202-)	UA	4
M-1	RHG	16
ME (3215-)	UA	4
NIFR (3219-)	MFRU	10
RBS-1	RHG	16
RBS-1	RHG	16
RC	RHA	16
RCS-1	RHA	16
RD-1	RHA	16
UFR (3218-)	MPFR	9
3211	MI-SADH	12
3601	MI-VB	14
Nystrom to MIFAB		
Nystrom	MIFAB	Page #
DTK	Contact MIFAB	-
FDDH	Contact MIFAB	-
FDDP	Contact MIFAB	-
FDE	FHG	15
FDN	FHA	15
FDR	Contact MIFAB	-
FRD	Contact MIFAB	-
FRV	Contact MIFAB	-
HS	MI-SADH	12
IP	MPFR-PL	9
IT	MPFR	9
IW	MPFR-DW	11
LW	UA	4
MP	MI-SAD-PL	12
MT	MI-SAD	12
MW	MI-SAD-DW	12
NP	CAD-FL-PL	7
NT	UA	4
NW	MDW	5
PL	PA	15
RA	CAD	5
RHA, RHG	RHA, RHG	16
RHE	Contact MIFAB	-
RHL	Contact MIFAB	-
RHS	Contact MIFAB	-
RV	Contact MIFAB	-
RW	CAD-DW	6
RP	CAD-PL	6
ST	MPFR-C	9
SW	MPFR-C-DW	11
TS	MI-SADH	12
UP	MFRU-PL	10
UT	MFRU	10
UW	MFRU-DW	10
XT	WID	17

PPP to MIFAB		
PPP	MIFAB	Page #
D-88PC	UA0808	4
D-88SS	UASS0808	4
D-814PC	UA0814	4
D-814SS	UASS0814	4
D-1212PC	UA1212	4
D-1212SS	UASS1212	4
D-1416PC	UA1416	4
D-1416SS	UASS1416	4
D-1620PC	UA1620	4
D-1620SS	UASS1620	4
D-2030PC	UA2030	4
D-2030SS	UASS2030	4
D-2424PC	UA2424	4
D-2424SS	UASS2424	4
F-88PC	MFRU0808	10
F-88SS	MFRUSS0808	10
F-814PC	MFRU0814	10
F-814SS	MFRUSS0814	10
F-1212PC	MFRU1212	10
F-1212SS	MFRUSS1212	10
F-1416PC	MFRU1416	10
F-1416SS	MFRUSS1416	10
F-1620PC	MFRU1620	10
F-1620SS	MFRUSS1620	10
F-2030PC	MFRU2030	10
F-2030SS	MFRUSS2030	10
F-2424PC	MFRU2424	10
F-2424SS	MFRUSS2424	10
Williams to MIFAB		
Williams	MIFAB	Page #
WB-AL-4000	Contact MIFAB	-
WB-AP-510	CAD-PL	6
WB-AT-600	CAD	5
WB-ATR-610	CAD-FR	8
WB-BASIC-300	UA	4
WB-DW-400	MDW	5
WB-EXT-1300	WID	17
WB-FR-400	MPFR	9
WB-FR-DW-820	MPFR-DW	11
WB-FR-PL-830	MPFR-PL	9
WB-FR-PL-840	MPFR-FL	9
WB-FR-PRE-700	MFRU	10
WB-FRB-900	MFRU	10
WB-FRC-50	MPFR	9
WB-FRU-810	MPFR	9
WB-GP-100	UA	4
WB-GY-3000	Contact MIFAB	-
WB-HG-SEC-1100	MI-SADH	12
WB-MAP	PA	15
WB-MD-SEC-1000	MI-SAD	12
WB-PL-500	CAD-FL-PL	7
WB-RP-110	MI-SF	13
WB-RDW-410	CAD-DW	6
WB-ROOF-HATCH	RHG	16
WB-SF-VC-FR	MI-VB	14
WB-SF-VC-S	MI-VB-SM	14
WB-SMP-120	MI-SF	13
WB-TB-1200	UA	4
WB-TYPE J + JD	FHG	15
WB-TYPE K + KD	FHA	15
WB-TYPE S + E	RHA	16
WB-TYPE T + TD	Contact MIFAB	-
WB-TYPE TER + TRD	Contact MIFAB	-
WB-TYPE Q	FHG	15
WB-UAD-200	UA	4
WB-WIN-1700	Contact MIFAB	-



MIFAB CATALOGS



**MPB-2024-CAN**  
SPECIFICATION DRAINAGE PRODUCTS (LIT-066)



**CLPB-2025**  
LIGHT COMMERCIAL DRAINAGE PRODUCTS (LIT-048)

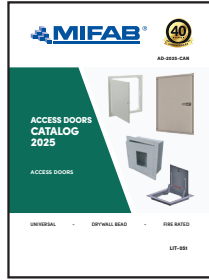

**AD-2025-CAN**  
ACCESS DOORS (LIT-051)



**BEECO-2025**  
BACKFLOW PREVENTERS, NO HUB COUPLINGS AND ACCESSORIES (LIT-071)



**NH-2025**  
NO HUB COUPLINGS AND ACCESSORIES (LIT-044)



**TGPC-2025**  
POLYMER CONCRETE TRENCH DRAINS (LIT-076)



**TD-2025**  
GRP AND STEEL TRENCH DRAINS (LIT-046)



**TSDS-2025**  
SHOWER DRAINS (LIT-077)



**TSS-2025**  
STAINLESS STEEL TRENCH DRAINS (LIT-072)



**ROOFGUARD-2020**  
ROOFGUARD ROOF DRAINS (LIT-058)



**C-PORT-2023**  
ROOFTOP RUBBER PIPE SUPPORTS (LIT-047)



**DB-2025**  
DIALYSIS BOXES (LIT-070)



**HYDROMAX-2020**  
SIPHONIC DRAINAGE (LIT-082)



**INT-2025**  
INTERCEPTORS & ACID NEUTRALIZATION TANKS (LIT-095)



**TSP-2024**  
TRAP SEAL PRIMERS (LIT-062)





**AD-2025-CAN**



# ACCESS DOORS CATALOG 2025

ACCESS DOORS

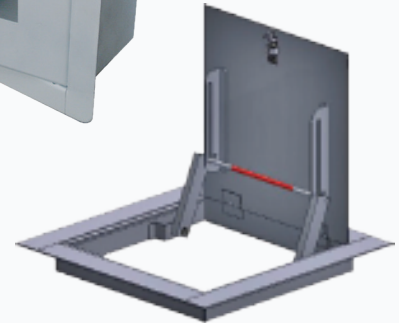

UNIVERSAL

-

DRYWALL BEAD

-

FIRE RATED

**LIT-051**