



**AD-2025-05-USA**

**ACCESS  
DOORS  
CATALOG  
2025**  
(May 15, 2025)

**ACCESS DOORS**



**UNIVERSAL**

-

**DRYWALL BEAD**

-

**FIRE RATED**

**LIT-043**

PICTORIAL INDEX

 <p>SERIES UA UNIVERSAL ACCESS DOOR (PAGE 4)</p>	 <p>SERIES MDW DRYWALL BEAD ACCESS DOOR (PAGE 5)</p>	 <p>SERIES CAD CEILING OR WALL ACCESS DOOR (PAGE 5)</p>	 <p>SERIES CAD-DW CEILING OR WALL ACCESS DOOR WITH DRYWALL BEAD (PAGE 6)</p>
 <p>SERIES CAD-PL CEILING OR WALL ACCESS DOOR, PLASTER FINISH (PAGE 6)</p>	 <p>SERIES CAD-FL CEILING OR WALL ACCESS DOOR, FLUSH DOOR WITH FRAME (PAGE 7)</p>	 <p>SERIES CAD-FL-PL CEILING OR WALL ACCESS DOOR, FLUSH DOOR WITH FRAME, PLASTER FINISH (PAGE 8)</p>	 <p>SERIES CAD-FR CEILING OR WALL ACCESS DOOR, FIRE RESISTANT (PAGE 8)</p>
 <p>SERIES MPFR INSULATED FIRE RATED ACCESS DOOR (PAGE 9)</p>	 <p>SERIES MFRU UNINSULATED FIRE RATED ACCESS DOOR (PAGE 10)</p>	 <p>SERIES MPFR-DW INSULATED FIRE RATED ACCESS DOOR WITH DRYWALL BEAD FRAME (PAGE 11)</p>	 <p>SERIES MI-SAD MEDIUM SECURITY ACCESS DOOR (PAGE 12)</p>
 <p>SERIES MI-SADH HIGH SECURITY ACCESS DOOR (PAGE 12)</p>	 <p>SERIES MI-FVP FLUSH VALVE PANEL (PAGE 13)</p>	 <p>SERIES MI-SF SURFACE ACCESS DOOR (PAGE 13)</p>	 <p>SERIES MI-VB, MI-VB-SM VALVE BOX (PAGE 14)</p>
 <p>MI-VB-SM WITH OPTIONAL CUT OUT OF DOOR TO ALLOW FOR GLASS OR PLASTIC WINDOW BY OTHERS. (PAGE 14)</p>	 <p>SERIES PA PLASTIC ACCESS DOOR (PAGE 15)</p>	 <p>SERIES FHA, FHG FLOOR ACCESS DOOR (PAGE 15)</p>	 <p>SERIES RHA, RHG ROOF HATCH DOOR (PAGE 16)</p>
 <p>LOCKS AND LATCHES (PAGE 16)</p>	 <p>SERIES WID EXTERIOR ACCESS DOOR/ WALK-IN DOOR (PAGE 17)</p>	<p><i>“MIFAB access doors are always readily available and easy to install. That’s why I only use MIFAB access doors. I use hundreds of MIFAB doors each year.”</i></p> <p>– Laine West, Owner, WWF Contractors, Rancho Cordova, CA</p>	

CALIFORNIA PROPOSITION 65 WARNING. This product contains chemicals known to the State of California to cause cancer and birth defects or other reproductive harm.

## TABLE OF CONTENTS

	DISCOUNT		DISCOUNT
<b>UA - Universal</b> .....	4	<b>MI-SAD - Medium Security</b> .....	12
<b>MDW - Drywall Bead</b> .....	5	<b>MI-SADH - High Security</b> .....	12
<b>CAD - 5/8" Recess for Drywall</b> .....	5	<b>MI-FVP - Flush Valve Panel</b> .....	13
<b>CAD-DW - 5/8" Recess for Drywall with Drywall Bead</b> .....	6	<b>MI-SF - Surface</b> .....	13
<b>CAD-PL - 5/8" Recess for Drywall with Plaster Lathe</b> .....	6	<b>MI-VB, MI-VB-SM - Valve Boxes</b> .....	14
<b>CAD-FL - 5/8" Recess in Frame, Door Flush with Frame</b> .....	7	<b>PA - Plastic</b> .....	15
<b>CAD-FL-PL - 5/8" Recess in Frame, Door Flush with Frame</b> .....	8	<b>FHA, FHG - Floor Access</b> .....	15
<b>CAD-FR - 1 1/2" Recess for Drywall</b> .....	8	<b>RHA, RHG - Roof Hatches</b> .....	16
<b>MPFR - Insulated, Fire Rated</b> .....	9	<b>Locks and Latches - Illustrated Locks Available</b> .....	16
<b>MFRU - Uninsulated, Fire Rated</b> .....	10	<b>WID - Exterior Access</b> .....	17
<b>MPFR-DW - Insulated, Fire Rated with Drywall Bead</b> .....	11	<b>Cross Reference</b> .....	18

## TERMS AND WARRANTIES

**WHOLESALE DISCOUNT:** Contact MIFAB® or your local representative for your applicable discount structure.

**FREIGHT ALLOWANCE:** Ex Works, MIFAB's Chicago, Illinois Factory or Manufacturer Representative's warehouse with full motor freight allowed on shipments of \$3,500.00 Net or more, within the continental U.S.A. and Canada, except Alaska, Hawaii and Puerto Rico. MIFAB reserves the right to choose the carrier and route of shipment. Alaska: Ex Works, Seattle, WA. Hawaii: Freight allowed on shipments of \$3,500.00 or more only when shipped from West Coast, U.S. Puerto Rico: Ex Works, Miami, Florida. There is no allowance for United Parcel Service, Federal Express or Shipment by air service. Full motor freight is allowed on shipments of \$3,500.00 Net or more, within the continental U.S.A. and Canada for any combination of BEECO, Counterline, No Hub Coupling, Trench Drain, Access Door and Trap Seal Primer products. Shipping dates are estimates and time of delivery is not the essence of the sale of the contract. Therefore, under no circumstances will MIFAB® have any responsibility on account of any delays in manufacture, transportation, or otherwise. Additional freight services such as construction site delivery, lift gate delivery service, re-consigned freight or notification charges, are not included in full freight allowance terms, and will result in additional freight charges. Note: there is no freight allowance for the SL Series of seamless access panels. All orders of the SL Series panels are freight extra.

**QUOTATION TERMS:** List Price and discount protected for 30 days from date issued by MIFAB®. Orders received within this period must be released for shipment within 30 days from date of purchase order, otherwise, prices will be those that are in effect at the time of shipment.

**PAYMENT TERMS:** Terms of payment are Net 30 days from the date of the invoice. All pricing in United States currency except for sales to Canadian customers which are priced in Canadian dollars. The Buyer shall pay all sales, consumers, and / or any other applicable taxes. Past due accounts will be subject to a 2% per month service charge from the date of the invoice. If any proceedings be instructed by or against Buyer under any bankruptcy or insolvency law, or if Buyer shall fail to make timely payment on this or any other order, or if, in MIFAB's judgment, Buyer's financial situation justifies such action, MIFAB® may, at its election, require payment in advance or cancel the order as to any unshipped item and require payment of its reasonable cancellation charges. If Buyer delays completion of manufacture, MIFAB® may elect to require payment according to percentage of completion. Equipment held for Buyer shall be at Buyer's risk and expense. In all cases, regardless of partial payment, title to the Products shall remain with MIFAB® until payment for the Products (including any notes given therefore) has been made in full. Should legal action be necessary to enforce payment of an unpaid invoice, the Buyer will assume full responsibility for any court costs and reasonable attorney fees. All orders subject to credit check and approval prior to shipment. Confirmed irrevocable letter of credit or cash in advance of shipment is required for accounts without an established line of credit. Minimum invoice amount is \$100.00. MIFAB® reserves the right to apply a minimum order charge to equal \$100.00. MIFAB's Accounting Department must be notified of potential pricing errors within 30 days of the invoice date. Any terms and conditions stated on Buyer's orders which are inconsistent with MIFAB's quotation and Terms and Warranties shall be of no effect.

**RETURNED GOODS RESTOCKING CHARGE:** Standard product may be returned within a one year period only with written permission from MIFAB®. All products in catalog are not considered Standard. Standard product to be determined by MIFAB®. Returned goods are subject to a 25% restocking charge, plus cost of reconditioning, if necessary, to make material saleable. Material must be returned to MIFAB® freight prepaid only after written permission from MIFAB® to accept the returned material. Buyer must provide copy of the original invoice on which the material was charged. The original outgoing freight cost to ship the order will be deducted from the credit. Credit allowance will be in the form of merchandise credit only-not cash credit which must be used within 12 months of the date of issue. The value of a return must total \$100.00 to qualify for credit allowance. No credit will be allowed for auxiliary tappings, discontinued, or made to order items. Products designated non stock and / or that have been specially made are not subject to return or cancellation.

**LIMITED WARRANTY:** MIFAB® warrants each product against defects in material and workmanship for a period of one year from the date of original shipment. In the event of such defects within the warranty period, MIFAB® will, at its option, replace or recondition the product without charge. This shall constitute the exclusive remedy for breach of warranty, and MIFAB® shall not be responsible for any incidental or consequential damages, including, without limitation, damages or other costs resulting from labor charges, delays, vandalism, negligence, fouling caused by foreign material, damage from adverse water conditions, chemicals, or any other circumstances over which MIFAB® has no control. This warranty shall be invalidated by any abuse, misuse, misapplication or improper installation of the product.

**MIFAB® MAKES NO OTHER WARRANTIES EXPRESSED OR IMPLIED AS PROVIDED IN THIS LIMITED WARRANTY.**

**ILLUSTRATIONS OR TYPICAL INSTALLATIONS:** The typical installations for various products in each product section are intended to illustrate the products and their options. Under no circumstances are they to be construed as recommended installation procedures. Consult local codes and project specifications for proper installation instructions.

**ALL SALES SUBJECT TO MIFAB's TERMS AND WARRANTIES.**

**NOTE:** Prices and terms are subject to change without notice and supersede all previous quotations. The right is reserved to change or modify product design or construction without prior notice and without incurring any obligation to make similar changes and modifications to product previously or subsequently sold. Contact MIFAB® for any clarification.

CONTENTS © MIFAB® INC. Copyright 2025

CALIFORNIA PROPOSITION 65 WARNING. This product contains chemicals known to the State of California to cause cancer and birth defects or other reproductive harm.

Design and dimensions are subject to modification. Prices do not include applicable taxes. Visit [www.mifab.com](http://www.mifab.com) for the most recent product information.

MIFAB®, Inc., 1321 West 119th Street, Chicago, Illinois 60643-5109, USA

Toll Free: 1-800-465-2736, Fax: 1-773-341-3049

All sales subject to MIFAB's® Terms and Warranties. Please refer to page no. 3.

sales@mifab.com Canada Toll Free: 1-800-387-3880

**SERIES UA**

**UNIVERSAL ACCESS DOOR**



**DESCRIPTION**

The MIFAB® UA is a multi-purpose access door. It is designed for flush installation into drywall, block or tile, walls and ceilings. The door features rounded safety corners, concealed hinge, flush with frame fit, a unique light color finish, and a 3/8" turn back in the door panel for extra rigidity and safety.

**SPECIFICATIONS**

**Material:** UA Series is 16 gauge satin coat steel door and 16 gauge satin coat steel frame. The UASS Stainless Steel Series is 16 gauge #304 stainless steel door and frame. Aluminum doors are available as an option up to the 24" x 24" (610 x 610) size. The door and frame is 16 gauge, Type 5052-32 aluminum.

**Finish:** Satin coat steel doors have a primed finish. Stainless steel doors have a #4 brush satin finish.

**Door:** Flush to frame. Turned back around edges for extra rigidity.

**Frame:** The frame has pre-punched mounting holes for simple installation.

**Hinge:** Concealed pivot pins.

**Latch:** Standard – Flush mounted, screwdriver operated cam. Optional – Allen key, cylinder key, paddle latch, or Vandal resistant (lock only) latch. All of MIFAB's cylinder key locks are keyed alike.

**Packaging:** Individual pack.

A-B Door Size

C-D Overall Dimensions - Door Size - Plus 2 1/8"

E-F Wall Opening - Door Size - Plus 3/8"

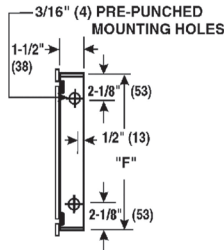
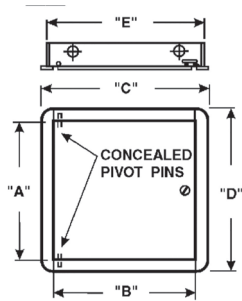

**Note:** The hinge is always furnished on the "A" or height (longer) dimension, unless otherwise specified.

\* Custom sized access doors are available. Contact your local MIFAB® representative for a quotation for any size access door you need.

"B" x "A"	WALL OPENING	SHIP WEIGHT (Lbs.)	LATCHES	MILD STEEL MODEL #	LIST PRICE MILD STEEL	STAINLESS STEEL MODEL #	LIST PRICE STAINLESS STEEL
6" x 6"	6 3/8" x 6 3/8"	1.90	1	UA0606	\$67.00	UASS0606	\$144.00
8" x 8"	8 3/8" x 8 3/8"	2.80	1	UA0808	\$69.00	UASS0808	\$164.00
8" x 12"	8 3/8" x 12 3/8"	3.80	1	UA0812	\$77.00	UASS0812	\$190.00
10" x 10"	10 3/8" x 10 3/8"	3.80	1	UA1010	\$80.00	UASS1010	\$202.00
12" x 12"	12 3/8" x 12 3/8"	5.00	1	UA1212	\$81.00	UASS1212	\$226.00
12" x 16"	12 3/8" x 16 3/8"	6.40	1	UA1216	\$99.00	UASS1216	\$265.00
12" x 18"	12 3/8" x 18 3/8"	7.10	1	UA1218	\$119.00	UASS1218	\$289.00
12" x 24"	12 3/8" x 24 3/8"	9.30	2	UA1224	\$146.00	UASS1224	\$332.00
14" x 14"	14 3/8" x 14 3/8"	6.40	1	UA1414	\$105.00	UASS1414	\$273.00
14" x 20"	14 3/8" x 20 3/8"	9.00	2	UA1420	\$149.00	UASS1420	\$377.00
14" x 24"	14 3/8" x 24 3/8"	12.00	2	UA1424	\$163.00	UASS1424	\$508.00
15" x 15"	15 3/8" x 15 3/8"	7.10	1	UA1515	\$119.00	UASS1515	\$297.00
16" x 16"	16 3/8" x 16 3/8"	7.90	1	UA1616	\$124.00	UASS1616	\$335.00
16" x 20"	16 3/8" x 20 3/8"	9.70	2	UA1620	\$149.00	UASS1620	\$364.00
16" x 24"	16 3/8" x 24 3/8"	11.40	2	UA1624	\$165.00	UASS1624	\$395.00
18" x 18"	18 3/8" x 18 3/8"	9.80	3	UA1818	\$147.00	UASS1818	\$384.00
18" x 24"	18 3/8" x 24 3/8"	12.70	5	UA1824	\$183.00	UASS1824	\$494.00
18" x 36"	18 3/8" x 36 3/8"	18.50	5	UA1836	\$266.00	UASS1836	\$659.00
20" x 20"	20 3/8" x 20 3/8"	11.70	3	UA2020	\$178.00	UASS2020	\$522.00
20" x 24"	20 3/8" x 24 3/8"	13.80	3	UA2024	\$200.00	UASS2024	\$537.00
20" x 30"	20 3/8" x 30 3/8"	16.90	5	UA2030	\$232.00	UASS2030	\$643.00
22" x 22"	22 3/8" x 22 3/8"	13.70	3	UA2222	\$195.00	UASS2222	\$590.00
22" x 30"	22 3/8" x 30 3/8"	18.20	5	UA2230	\$272.00	UASS2230	\$692.00
24" x 24"	24 3/8" x 24 3/8"	15.90	3	UA2424	\$202.00	UASS2424	\$629.00
24" x 30"	24 3/8" x 30 3/8"	19.60	5	UA2430	\$289.00	UASS2430	\$719.00
24" x 36"	24 3/8" x 36 3/8"	23.20	6	UA2436	\$302.00	UASS2436	\$793.00
24" x 48"	24 3/8" x 48 3/8"	28.00	7	UA2448	\$345.00	UASS2448	\$928.00
30" x 30"	30 3/8" x 30 3/8"	23.50	7	UA3030	\$329.00	UASS3030	\$825.00
32" x 32"	32 3/8" x 32 3/8"	26.40	5	UA3232	\$329.00	UASS3232	\$896.00
36" x 36"	36 3/8" x 36 3/8"	32.70	8	UA3636	\$388.00	UASS3636	\$1,092.00
36" x 48"	36 3/8" x 48 3/8"	43.00	5	UA3648	\$401.00	UASS3648	\$1,153.00
48" x 48"	48 3/8" x 48 3/8"	46.00	5	UA4848	\$423.00	UASS4848	\$1,215.00

**UA OPTIONAL VARIATIONS**

SUFFIX	DESCRIPTION	LIST PRICE, EACH
-A	Allen key lock	\$31.00
-AL	Aluminum material	Use Stainless Steel List Price for same size door
-C	Cylinder key lock	\$43.00
-PL	Paddle latch	\$105.00
-VP	Vandal resistant (lock only)	\$105.00
-WR	Water resistant	\$166.00

*"The MIFAB access doors were delivered as promised the next day. No problems reported from the field. My guys say they like the availability and the cardboard packaging they come in."*

– Anthony Upton, Allcom Plumbing, Inc.,  
Yuba City, CA

CALIFORNIA PROPOSITION 65 WARNING. This product contains chemicals known to the State of California to cause cancer and birth defects or other reproductive harm.

**SERIES MDW DRYWALL BEAD ACCESS DOOR**
**DESCRIPTION**

The MIFAB® MDW access door is designed for installation after the drywall has been applied and when a concealed outer flange is required. The outer frame has a galvanized drywall taping bead. Drywall cement can be applied over the beading at the same time as the wallboard joints and corners. Only the door is visible. It has a light color finish.

**SPECIFICATIONS**

**Material:** MDW Series is 16 gauge satin coat steel door and 16 gauge satin coat steel frame. The MDWSS Stainless Steel Series is 16 gauge #304 stainless steel door and frame.

**Finish:** Satin coat steel doors have a primed finish. Stainless steel doors have a #4 brush satin finish.

**Door:** Flush to frame. Turned back around edges for extra rigidity.

**Frame:** Drywall taping bead on all sides.

**Hinge:** Concealed pivot pins.

**Latch:** Standard – Flush mounted, screwdriver operated cam. Optional – Allen key, cylinder key, paddle latch, or Vandal resistant (lock only) latch. All of MIFAB's cylinder key locks are keyed alike.

**Packaging:** Individual pack.

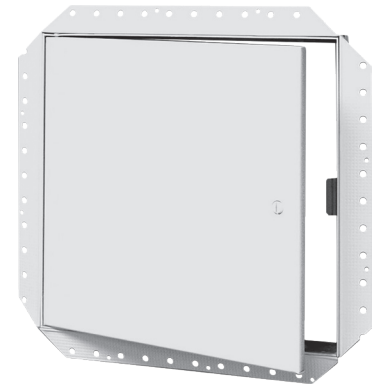

"B" x "A"	WALL OPENING	SHIP WEIGHT (Lbs.)	LATCHES	MILD STEEL MODEL #	LIST PRICE MILD STEEL	STAINLESS STEEL MODEL #	LIST PRICE STAINLESS STEEL
8" x 8"	8 3/8" x 8 3/8"	3.5	1	MDW0808	\$107.00	MDWSS0808	\$299.00
10" x 10"	10 3/8" x 10 3/8"	4.5	1	MDW1010	\$107.00	MDWSS1010	\$360.00
12" x 12"	12 3/8" x 12 3/8"	6.0	1	MDW1212	\$115.00	MDWSS1212	\$420.00
14" x 14"	14 3/8" x 14 3/8"	7.0	1	MDW1414	\$128.00	MDWSS1414	\$468.00
16" x 16"	16 3/8" x 16 3/8"	8.0	1	MDW1616	\$146.00	MDWSS1616	\$508.00
18" x 18"	18 3/8" x 18 3/8"	12.0	3	MDW1818	\$169.00	MDWSS1818	\$629.00
22" x 22"	22 3/8" x 22 3/8"	14.0	3	MDW2222	\$247.00	MDWSS2222	\$839.00
24" x 24"	24 3/8" x 24 3/8"	17.5	3	MDW2424	\$285.00	MDWSS2424	\$928.00
24" x 36"	24 3/8" x 36 3/8"	21	5	MDW2436	\$381.00	MDWSS2436	\$1,007.00
30" x 30"	30 3/8" x 30 3/8"	22	5	MDW3030	\$417.00	MDWSS3030	\$1,050.00
36" x 36"	36 3/8" x 36 3/8"	32	5	MDW3636	\$494.00	MDWSS3636	\$1,387.00

MDW OPTIONAL VARIATIONS		
SUFFIX	DESCRIPTION	LIST PRICE, EACH
-A	Allen key lock	\$31.00
-C	Cylinder key lock	\$43.00
-PL	Paddle latch	\$105.00
-VP	Vandal resistant (lock only)	\$105.00
-WR	Water resistant	\$166.00

**NOTE:** The hinge is always furnished on the "A" or height (longer) dimension, unless otherwise specified.

\* Custom sized access doors are available. Contact your local MIFAB® representative for a quotation for any size access door you need.

**SERIES CAD CEILING OR WALL ACCESS DOOR**
**DESCRIPTION**

The MIFAB® CAD recessed access door is designed for use in acoustical, drywall or tiled surfaces. The door panel is recessed 5/8" (15) to allow the insertion of various types of material.

**SPECIFICATIONS**

**Material:** CAD Series is 16 gauge satin coat steel door and 16 gauge satin coat steel frame. The CADSS Stainless Steel Series is 16 gauge #304 stainless steel door and frame.

**Finish:** Satin coat steel doors have a primed finish. Stainless steel doors have a #4 brush satin finish.

**Door:** Recessed 5/8" (15) door pan to accept tile, drywall or other finishing materials.

**Frame:** Flush to surface.

**Hinge:** Concealed pivot pins.

**Latch:** Standard – Flush mounted, screwdriver operated cam. Optional – Allen key, cylinder key, or Vandal resistant (lock only) latch. All of MIFAB's cylinder key locks are keyed alike.

**Packaging:** Individual pack.

\* Custom sized access doors are available. Contact your local MIFAB® representative for a quotation for any size access door you need.



"B" x "A"	WALL OPENING	SHIP WEIGHT (Lbs.)	LATCHES	MILD STEEL MODEL #	LIST PRICE MILD STEEL	STAINLESS STEEL MODEL #	LIST PRICE STAINLESS STEEL
8" x 8"	8 3/16" x 8 3/16"	4.5	1	CAD0808	\$107.00	CADSS0808	\$343.00
12" x 12"	12 3/16" x 12 3/16"	7.0	1	CAD1212	\$124.00	CADSS1212	\$399.00
12" x 24"	12 3/16" x 24 3/16"	12.0	2	CAD1224	\$193.00	CADSS1224	\$595.00
14" x 14"	14 3/16" x 14 3/16"	9.0	2	CAD1414	\$164.00	CADSS1414	\$507.00
16" x 16"	16 3/16" x 16 3/16"	10.5	2	CAD1616	\$193.00	CADSS1616	\$576.00
18" x 18"	18 3/16" x 18 3/16"	12.0	3	CAD1818	\$249.00	CADSS1818	\$595.00
24" x 24"	24 3/16" x 24 3/16"	18.5	4	CAD2424	\$249.00	CADSS2424	\$767.00
24" x 36"	24 3/16" x 36 3/16"	22.0	5	CAD2436	\$328.00	CADSS2436	\$1,018.00

CAD OPTIONAL VARIATIONS		
SUFFIX	DESCRIPTION	LIST PRICE, EACH
-A	Allen key lock	\$31.00
-C	Cylinder key lock	\$43.00
-VP	Vandal resistant (lock only)	\$105.00

**NOTE:** The hinge is always furnished on the "A" or height (longer) dimension, unless otherwise specified.

CALIFORNIA PROPOSITION 65 WARNING. This product contains chemicals known to the State of California to cause cancer and birth defects or other reproductive harm.

Design and dimensions are subject to modification. Prices do not include applicable taxes.

Visit [www.mifab.com](http://www.mifab.com) for the most recent product information.

MIFAB®, Inc., 1321 West 119th Street, Chicago, Illinois 60643-5109, USA

Toll Free: 1-800-465-2736, Fax: 1-773-341-3049

All sales subject to MIFAB's® Terms and Warranties. Please refer to page no. 3.

sales@mifab.com Canada Toll Free: 1-800-387-3880



**SERIES CAD-DW**
**CEILING OR WALL ACCESS DOOR WITH DRYWALL BEAD**

**DESCRIPTION**

The MIFAB® CAD-DW recessed access door is designed for use in acoustical, drywall or tiled surfaces. The door panel is recessed 5/8" (15) to allow the insertion of various types of material. It has a light color finish. The outer frame has a galvanized drywall taping bead. Drywall cement can be applied over the beading at the same time as the wallboard joints and corners.

**SPECIFICATIONS**

**Material:** CAD-DW Series is 16 gauge satin coat steel door and 16 gauge satin coat steel frame. The CAD-DWSS is 16 gauge #304 stainless steel door and frame.

**Finish:** Satin coat steel doors have a primed finish. Stainless steel doors have a #4 brush satin finish.

**Door:** Recessed 5/8" (15) door pan to accept tile, drywall or other finishing materials.

**Frame:** Drywall corner bead on all sides.

**Hinge:** Concealed pivot pins.

**Latch:** Standard – Flush mounted, screwdriver operated cam. Optional – Allen key, cylinder key, or Vandal resistant (lock only) latch. All of MIFAB's cylinder key locks are keyed alike.

**Packaging:** Individual pack.

*"We purchase MIFAB Access Doors because they are readily available and competitively priced."*

– Ronald Wheelless, Manager,  
Mid South Plumbing and  
Electrical Supply, Jonesboro, AR

\* Custom sized access doors are available. Contact your local MIFAB® representative for a quotation for any size access door you need.

CAD-DW OPTIONAL VARIATIONS		
SUFFIX	DESCRIPTION	LIST PRICE, EACH
-A	Allen key lock	\$31.00
-C	Cylinder key lock	\$43.00
-VP	Vandal resistant (lock only)	\$105.00
-WR	Water resistant	\$166.00

"B" x "A"	WALL OPENING	SHIP WEIGHT (Lbs.)	LATCHES	MILD STEEL MODEL #	LIST PRICE MILD STEEL	STAINLESS STEEL MODEL #	LIST PRICE STAINLESS STEEL
8" x 8"	8 3/16" x 8 3/16"	5.0	1	CAD-DW0808	\$165.00	CAD-DWSS0808	\$519.00
12" x 12"	12 3/16" x 12 3/16"	7.5	1	CAD-DW1212	\$191.00	CAD-DWSS1212	\$602.00
12" x 24"	12 3/16" x 24 3/16"	13.0	2	CAD-DW1224	\$249.00	CAD-DWSS1224	\$797.00
14" x 14"	14 3/16" x 14 3/16"	9.5	2	CAD-DW1414	\$221.00	CAD-DWSS1414	\$698.00
16" x 16"	16 3/16" x 16 3/16"	11.5	2	CAD-DW1616	\$252.00	CAD-DWSS1616	\$797.00
18" x 18"	18 3/16" x 18 3/16"	13.0	3	CAD-DW1818	\$269.00	CAD-DWSS1818	\$849.00
24" x 24"	24 3/16" x 24 3/16"	19.5	4	CAD-DW2424	\$315.00	CAD-DWSS2424	\$995.00
24" x 36"	24 3/16" x 36 3/16"	23.0	5	CAD-DW2436	\$408.00	CAD-DWSS2436	\$1,292.00

**NOTE:** The hinge is always furnished on the "A" or height (longer) dimension, unless otherwise specified.

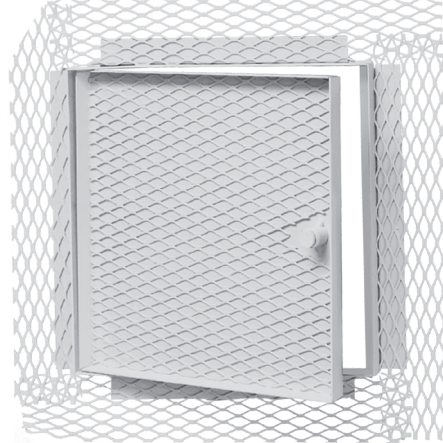
**SERIES CAD-PL**
**CEILING OR WALL ACCESS DOOR, PLASTER FINISH**

The MIFAB® CAD-PL recessed access door is designed for use in acoustical plaster walls and ceilings. The door panel is recessed 5/8" (15) and is lined with a self-furring metal lath to allow the insertion of plaster within the door panel. A 2 3/4" (70) wide metal lath extends from the perimeter of the frame. Only the thickness of the door and frame edges are exposed. It has a light color finish.

**SPECIFICATIONS**

**Material:** CAD-PL Series is 16 gauge satin coat steel door and 16 gauge satin coat steel frame. The CAD-PLSS Stainless Steel Series is 16 gauge #304 stainless steel door and frame.

**Finish:** Satin coat steel doors have a primed finish. Stainless steel doors have a #4 brush satin finish.

**Door:** Recessed 5/8" (15) door pan with self-furring metal lath to accept plaster.

**Frame:** Mounting flange is 1 1/8" (28) wide and recessed 5/8" (15) from the door and lined with a 2 3/4" (70) wide self-furring metal lath.

**Hinge:** Concealed pivot pins.

**Latch:** Standard - Flush mounted, screwdriver operated cam. Optional – Allen key, cylinder key, or Vandal resistant (lock only) latch. All of MIFAB's cylinder key lock are keyed alike.

**Packaging:** Individual pack.

\* Custom sized access doors are available. Contact your local MIFAB® representative for a quotation for any size access door you need.

CAD-PL OPTIONAL VARIATIONS		
SUFFIX	DESCRIPTION	LIST PRICE, EACH
-A	Allen key lock	\$31.00
-C	Cylinder key lock	\$43.00
-VP	Vandal resistant (lock only)	\$105.00

"B" x "A"	WALL OPENING	SHIP WEIGHT (Lbs.)	LATCHES	MILD STEEL MODEL #	LIST PRICE MILD STEEL	STAINLESS STEEL MODEL #	LIST PRICE STAINLESS STEEL
12" x 12"	12 3/16" x 12 3/16"	8.5	1	CAD-PL1212	\$228.00	CAD-PLSS1212	\$725.00
12" x 24"	12 3/16" x 24 3/16"	15.0	1	CAD-PL1224	\$367.00	CAD-PLSS1224	\$1,164.00
18" x 18"	18 3/16" x 18 3/16"	15.0	2	CAD-PL1818	\$367.00	CAD-PLSS1818	\$1,164.00
24" x 24"	24 3/16" x 24 3/16"	23.0	4	CAD-PL2424	\$437.00	CAD-PLSS2424	\$1,393.00
24" x 36"	24 3/16" x 36 3/16"	27.0	5	CAD-PL2436	\$643.00	CAD-PLSS2436	\$2,036.00

**NOTE:** The hinge is always furnished on the "A" or height (longer) dimension, unless otherwise specified.

CALIFORNIA PROPOSITION 65 WARNING. This product contains chemicals known to the State of California to cause cancer and birth defects or other reproductive harm.

**SERIES CAD-FL**
**CEILING OR WALL ACCESS DOOR, FLUSH DOOR WITH FRAME**
**DESCRIPTION**

The MIFAB® CAD-FL access door is designed for flush installation in drywall or plaster surfaces. The door panel is flush with the frame. When installed flush with the wall or ceiling, only the door panel is exposed. A mounting bracket is recessed 5/8" (15) from the door. It has a light color finish.

**SPECIFICATIONS**

**Material:** CAD-FL Series is a 16 gauge satin coat door and a 16 gauge satin coat frame. The CAD-FLSS Stainless Steel Series is 16 gauge #304 stainless steel door and frame.

**Finish:** Satin coat steel doors have a primed finish. Stainless steel doors have a #4 brush satin finish.

**Door:** Flush to frame. Turned back around edges for extra rigidity.

**Frame:** Flush to surface. Mounting flange is 1 1/8" (28) wide and recessed 5/8" (15) from the door.

**Hinge:** Concealed pivot pins.

**Latch:** Standard – Flush mounted, screwdriver operated cam. Optional – Allen key, cylinder key, paddle latch, or Vandal resistant (lock only) latch. All of MIFAB's cylinder key locks are keyed alike.

**Packaging:** Individual pack.



"B" x "A"	WALL OPENING	SHIP WEIGHT (Lbs.)	LATCHES	MILD STEEL MODEL #	LIST PRICE MILD STEEL	STAINLESS STEEL MODEL #	LIST PRICE STAINLESS STEEL
8" x 8"	8 3/16" x 8 3/16"	4.0	1	CAD-FL0808	\$108.00	CAD-FLSS0808	\$222.00
8" x 12"	8 3/16" x 12 3/16"	5.0	1	CAD-FL0812	\$126.00	CAD-FLSS0812	\$270.00
10" x 10"	10 3/16" x 10 3/16"	5.5	1	CAD-FL1010	\$132.00	CAD-FLSS1010	\$283.00
12" x 12"	12 3/16" x 12 3/16"	6.0	1	CAD-FL1212	\$145.00	CAD-FLSS1212	\$297.00
12" x 16"	12 3/16" x 16 3/16"	7.0	1	CAD-FL1216	\$160.00	CAD-FLSS1216	\$335.00
12" x 18"	12 3/16" x 18 3/16"	8.0	1	CAD-FL1218	\$167.00	CAD-FLSS1218	\$404.00
12" x 24"	12 3/16" x 24 3/16"	11.4	3	CAD-FL1224	\$216.00	CAD-FLSS1224	\$537.00
14" x 14"	14 3/16" x 14 3/16"	7.8	1	CAD-FL1414	\$183.00	CAD-FLSS1414	\$388.00
16" x 16"	16 3/16" x 16 3/16"	9.6	1	CAD-FL1616	\$178.00	CAD-FLSS1616	\$420.00
16" x 20"	16 3/16" x 20 3/16"	11.4	1	CAD-FL1620	\$216.00	CAD-FLSS1620	\$537.00
18" x 18"	18 3/16" x 18 3/16"	11.4	3	CAD-FL1818	\$225.00	CAD-FLSS1818	\$643.00
18" x 24"	18 3/16" x 24 3/16"	15.9	3	CAD-FL1824	\$314.00	CAD-FLSS1824	\$734.00
20" x 24"	20 3/16" x 24 3/16"	17.0	3	CAD-FL2024	\$347.00	CAD-FLSS2024	\$823.00
20" x 30"	20 3/16" x 30 3/16"	19.0	5	CAD-FL2030	\$403.00	CAD-FLSS2030	\$973.00
24" x 24"	24 3/16" x 24 3/16"	18.3	3	CAD-FL2424	\$388.00	CAD-FLSS2424	\$853.00
24" x 30"	24 3/16" x 30 3/16"	20.0	5	CAD-FL2430	\$441.00	CAD-FLSS2430	\$1,032.00
24" x 36"	24 3/16" x 36 3/16"	24.5	5	CAD-FL2436	\$509.00	CAD-FLSS2436	\$1,121.00
30" x 30"	30 3/16" x 30 3/16"	24.5	5	CAD-FL3030	\$515.00	CAD-FLSS3030	\$1,153.00
36" x 36"	36 3/16" x 36 3/16"	28.0	5	CAD-FL3636	\$608.00	CAD-FLSS3636	\$1,334.00

**CAD-FL OPTIONAL VARIATIONS**

SUFFIX	DESCRIPTION	LIST PRICE, EACH
-A	Allen key lock	\$31.00
-C	Cylinder key lock	\$43.00
-PL	Paddle latch	\$105.00
-VP	Vandal resistant (lock only)	\$105.00

**NOTE:** The hinge is always furnished on the "A" or height (longer) dimension, unless otherwise specified.

\* Custom sized access doors are available. Contact your local MIFAB® representative for a quotation for any size access door you need.

CALIFORNIA PROPOSITION 65 WARNING. This product contains chemicals known to the State of California to cause cancer and birth defects or other reproductive harm.

Design and dimensions are subject to modification. Prices do not include applicable taxes.

Visit [www.mifab.com](http://www.mifab.com) for the most recent product information.

MIFAB®, Inc., 1321 West 119th Street, Chicago, Illinois 60643-5109, USA

Toll Free: 1-800-465-2736, Fax: 1-773-341-3049

All sales subject to MIFAB's® Terms and Warranties. Please refer to page no. 3.

sales@mifab.com Canada Toll Free: 1-800-387-3880

**SERIES CAD-FL-PL**
**CEILING OR WALL ACCESS DOOR, FLUSH DOOR WITH FRAME, PLASTER FINISH**
**DESCRIPTION**

The MIFAB® CAD-FL-PL recessed access door is designed for flush installation in drywall or plaster surfaces. The door panel is flush with the frame. When installed flush with the wall or ceiling, only the door panel is exposed. A 2 3/4" (70) wide metal lath on all sides provides a rigid frame. A mounting bracket is recessed 5/8" (15) from the door. It has a light color finish.

**SPECIFICATIONS**

**Material:** CAD-FL-PL Series is a 16 gauge satin coat door and a 16 gauge satin coat frame.

The CAD-FL-PLSS Stainless Steel Series is 16 gauge #304 stainless steel door and frame.

**Finish:** Satin coat steel doors have a primed finish. Stainless steel doors have a #4 brush satin finish.

**Door:** Flush to frame. Turned back around edges for extra rigidity.

**Frame:** Mounting flange is 1 1/8" (28) wide and recessed 5/8" (15) from the door. A 2 3/4" (70) wide self furring metal lath lines the flange.

**Hinge:** Concealed pivot pins.

**Latch:** Standard – Flush mounted, screwdriver operated cam. Optional – Allen key, cylinder key, paddle latch, or Vandal resistant (lock only) latch. All of MIFAB's cylinder key locks are keyed alike.

**Packaging:** Individual pack.



"B" x "A"	WALL OPENING	SHIP WEIGHT (Lbs.)	LATCHES	MILD STEEL MODEL #	LIST PRICE MILD STEEL	STAINLESS STEEL MODEL #	LIST PRICE STAINLESS STEEL
8" x 8"	8 3/16" x 8 3/16"	4.0	1	CAD-FL-PL0808	\$105.00	CAD-FL-PLSS0808	\$222.00
8" x 12"	8 3/16" x 12 3/16"	5.0	1	CAD-FL-PL0812	\$119.00	CAD-FL-PLSS0812	\$270.00
10" x 10"	10 3/16" x 10 3/16"	5.5	1	CAD-FL-PL1010	\$125.00	CAD-FL-PLSS1010	\$283.00
12" x 12"	12 3/16" x 12 3/16"	6.0	1	CAD-FL-PL1212	\$132.00	CAD-FL-PLSS1212	\$299.00
12" x 16"	12 3/16" x 16 3/16"	7.0	1	CAD-FL-PL1216	\$152.00	CAD-FL-PLSS1216	\$327.00
12" x 18"	12 3/16" x 18 3/16"	8.0	1	CAD-FL-PL1218	\$167.00	CAD-FL-PLSS1218	\$384.00
12" x 24"	12 3/16" x 24 3/16"	11.4	2	CAD-FL-PL1224	\$201.00	CAD-FL-PLSS1224	\$441.00
14" x 14"	14 3/16" x 14 3/16"	7.8	1	CAD-FL-PL1414	\$164.00	CAD-FL-PLSS1414	\$407.00
16" x 16"	16 3/16" x 16 3/16"	9.6	1	CAD-FL-PL1616	\$182.00	CAD-FL-PLSS1616	\$420.00
16" x 20"	16 3/16" x 20 3/16"	11.4	1	CAD-FL-PL1620	\$209.00	CAD-FL-PLSS1620	\$539.00
18" x 18"	18 3/16" x 18 3/16"	11.4	3	CAD-FL-PL1818	\$210.00	CAD-FL-PLSS1818	\$659.00
18" x 24"	18 3/16" x 24 3/16"	15.9	3	CAD-FL-PL1824	\$285.00	CAD-FL-PLSS1824	\$719.00
20" x 24"	20 3/16" x 24 3/16"	17.0	3	CAD-FL-PL2024	\$328.00	CAD-FL-PLSS2024	\$749.00
20" x 30"	20 3/16" x 30 3/16"	19.0	5	CAD-FL-PL2030	\$416.00	CAD-FL-PLSS2030	\$808.00
24" x 24"	24 3/16" x 24 3/16"	18.3	3	CAD-FL-PL2424	\$398.00	CAD-FL-PLSS2424	\$839.00
24" x 30"	24 3/16" x 30 3/16"	20.0	5	CAD-FL-PL2430	\$506.00	CAD-FL-PLSS2430	\$990.00
24" x 36"	24 3/16" x 36 3/16"	24.5	5	CAD-FL-PL2436	\$580.00	CAD-FL-PLSS2436	\$1,137.00
30" x 30"	30 3/16" x 30 3/16"	24.5	5	CAD-FL-PL3030	\$593.00	CAD-FL-PLSS3030	\$1,153.00
36" x 36"	36 3/16" x 36 3/16"	28.0	5	CAD-FL-PL3636	\$639.00	CAD-FL-PLSS3636	\$1,302.00

**SERIES CAD-FR**
**CEILING OR WALL ACCESS DOOR, FIRE RESISTANT**

**DESCRIPTION**

The MIFAB CAD-FR fire resistant access door is designed for use in a suspended drywall ceiling. The CAD-FR is not fire rated. However, the combination of steel and fire rated tile supplied by others may maintain the fire resistant quality of the ceiling assembly. The door panel is recessed 1 1/2" to accommodate dual layered ceiling tile. Consult local Fire Codes for each application.

**SPECIFICATIONS**

**Material:** CAD-FR Series is 16 gauge satin coat steel door and 16 gauge satin coat steel frame. The CAD-FRSS stainless steel Series is 16 gauge # 304 stainless steel door and frame.

**Finish:** Satin coat steel doors have a primed finish. Stainless steel doors have a #4 brush satin finish.

**Door:** Recessed 1 1/2" (38) door panel to accept tile, drywall or finishing materials.

**Frame:** Flush to surface. Mounting flange is 1 1/8" (28) wide and recessed 5/8" (16) from the door.

**Hinge:** Concealed pivot pins

**Latch:** Standard – Flush Mounted, screwdriver operated cam. Optional – Allen key, cylinder key, or Vandal resistant (lock only) latch. All of MIFAB's cylinder key locks are keyed alike.

**Packaging:** Individual pack.

CAD-FR OPTIONAL VARIATIONS		
SUFFIX	DESCRIPTION	LIST PRICE, EACH
-A	Allen key lock	\$31.00
-C	Cylinder key lock	\$43.00
-VP	Vandal resistant (lock only)	\$105.00

"B" x "A"	WALL OPENING	SHIP WEIGHT (Lbs.)	LATCHES	MILD STEEL MODEL #	LIST PRICE MILD STEEL	STAINLESS STEEL MODEL #	LIST PRICE STAINLESS STEEL
12" x 12"	12 1/2" x 12 1/2"	7.3	1	CAD-FR1212	\$215.00	CAD-FRSS1212	\$678.00
18" x 18"	18 1/2" x 18 1/2"	12.5	1	CAD-FR1818	\$245.00	CAD-FRSS1818	\$776.00
24" x 24"	24 1/2" x 24 1/2"	21.8	3	CAD-FR2424	\$315.00	CAD-FRSS2424	\$1,002.00
22" x 30"	22 1/2" x 30 1/2"	26.0	4	CAD-FR2230	\$362.00	CAD-FRSS2230	\$1,155.00

**NOTE:** The hinge is always furnished on the "A" or height (longer) dimension, unless otherwise specified.

\* Custom sized access doors are available. Contact your local MIFAB® representative for a quotation for any size access door you need.

CALIFORNIA PROPOSITION 65 WARNING. This product contains chemicals known to the State of California to cause cancer and birth defects or other reproductive harm.



**SERIES MPFR INSULATED FIRE RATED ACCESS DOOR**
**DESCRIPTION**

The MIFAB® MPFR fire rated access door is approved by Underwriters Laboratories Inc., for 1 1/2 hours, "B" label in walls and is approved by Warnock Hersey for 2 hours in ceilings and 3 hours in walls. The door meets ANSI-UL 10B standards. The same door can be used in walls and ceilings. Tests were conducted using mild steel and Type 304 stainless steel.

**SPECIFICATIONS**

**Material:** MPFR Series is 16 gauge satin coat steel front door with 20 gauge backliner and 16 gauge satin coat steel frame. The MPFRSS Stainless Steel Series is 16 gauge #304 stainless steel front door with 20 gauge backliner and 16 gauge #304 stainless steel frame.

**Finish:** Satin coat steel doors have a primed finish. Stainless steel doors have a #4 brush satin finish.

**Door:** Flush to frame. Self-closing. Can be opened from the inside or back of the door with MIFAB's unique thumb turn latch.

**Frame:** Four piece welded frame with masonry mounting straps.

**Hinge:** Concealed pivot pins.

**Spring:** Heavy duty. An extra spring is provided with every door greater than 14" x 14" (356 x 356) for ceiling installation. Both springs must be attached to the door to ensure that the door will close when installed in the ceiling.

**Latch:** Standard – Flush mounted, interchangeable turn ring operator and key operator latch. Optional - cylinder key lock. All of MIFAB's cylinder key locks are keyed alike.

**Fire Rating:** Underwriters Laboratories "B" label. 1½ hours for walls. Warnock Hersey: 1 hour combustible ceilings and walls, 2 hour non-combustible ceilings, and 3 hour non-combustible walls. Ceiling fire ratings are up to and including the 24" x 36" (610 x 914) size.

**Insulation:** Roxul Rockboard 80. 2" (50) thick and fire retardant.

**Packaging:** Individual pack.



\* Custom sized access doors are available. Contact your local MIFAB® representative for a quotation for any size access door you need.

"B" x "A"	WALL OPENING	SHIP WEIGHT (Lbs.)	LATCHES	MILD STEEL MODEL #	LIST PRICE MILD STEEL	STAINLESS STEEL MODEL #	LIST PRICE STAINLESS STEEL
8" x 8"	8 1/2" x 8 1/2"	10.0	1	MPFR0808	\$346.00	MPFRSS0808	\$1,081.00
10" x 10"	10 1/2" x 10 1/2"	12.0	1	MPFR1010	\$352.00	MPFRSS1010	\$1,101.00
12" x 12"	12 1/2" x 12 1/2"	14.0	1	MPFR1212	\$359.00	MPFRSS1212	\$1,121.00
12" x 18"	12 1/2" x 18 1/2"	16.0	1	MPFR1218	\$455.00	MPFRSS1218	\$1,396.00
12" x 24"	12 1/2" x 24 1/2"	19.0	1	MPFR1224	\$477.00	MPFRSS1224	\$1,368.00
14" x 14"	14 1/2" x 14 1/2"	15.5	1	MPFR1414	\$388.00	MPFRSS1414	\$1,215.00
16" x 16"	16 1/2" x 16 1/2"	16.5	1	MPFR1616	\$448.00	MPFRSS1616	\$1,396.00
18" x 18"	18 1/2" x 18 1/2"	19.0	1	MPFR1818	\$466.00	MPFRSS1818	\$1,460.00
20" x 20"	20 1/2" x 20 1/2"	24.0	1	MPFR2020	\$483.00	MPFRSS2020	\$1,519.00
22" x 22"	22 1/2" x 22 1/2"	28.0	1	MPFR2222	\$661.00	MPFRSS2222	\$1,536.00
22" x 30"	22 1/2" x 30 1/2"	35.0	2	MPFR2230	\$831.00	MPFRSS2230	\$2,232.00
24" x 24"	24 1/2" x 24 1/2"	30.0	1	MPFR2424	\$656.00	MPFRSS2424	\$1,714.00
24" x 36"	24 1/2" x 36 1/2"	46.0	2	MPFR2436	\$985.00	MPFRSS2436	\$2,256.00
24" x 48"	24 1/2" x 48 1/2"	65.0	2	MPFR2448	\$1,239.00	MPFRSS2448	\$2,519.00
30" x 30"	30 1/2" x 30 1/2"	45.0	1	MPFR3030	\$1,030.00	MPFRSS3030	\$2,137.00
32" x 32"	32 1/2" x 32 1/2"	47.0	1	MPFR3232	\$1,239.00	MPFRSS3232	\$3,073.00
36" x 36"	36 1/2" x 36 1/2"	60.0	2	MPFR3636	\$1,442.00	MPFRSS3636	\$3,382.00
36" x 48"	36 1/2" x 48 1/2"	80.0	2	MPFR3648	\$1,652.00	MPFRSS3648	\$4,537.00

The access door construction design (lock and hinge) cannot be changed without affecting the Warnock Hersey and cUL approvals.

**Warnock Hersey**



California State Fire Marshall Approval #3330-1535:00

**MPFR OPTIONAL VARIATIONS**

SUFFIX	DESCRIPTION	LIST PRICE, EACH
-C	Cylinder key lock	\$43.00

**Note:** The hinge is always furnished on the "A" or height (longer) dimension, unless otherwise specified.

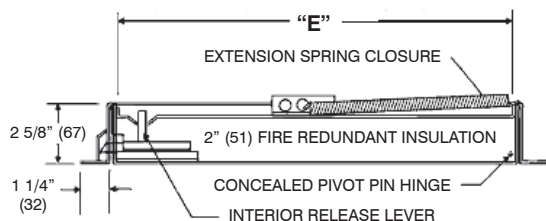
**Note:** Custom sized MPFR Series of access doors cannot exceed 1,728 square inches with the fire rated approval.



*"We rely on MIFAB's Access Doors for all of our multi-family work. Their fast service, consistent quality and broad product mix let's us get fire rated to standard doors fast and on budget."*

– Lawrence Tognetti, Manager, Lovazzano Mechanical, Menlo Park, CA



A-B Door Size C-D Overall Dimensions - Door Size - Plus 2 5/8" (67) E Wall Opening - Door Size - Plus 1/2" (13) (Allow an extra 1/4" (6) clearance for latch housing on "D" side.)

The Key Operator and Turn Ring Operator keys are shipped with every MPFR fire rated access door. If additional keys are required, please order them by Part # KEY-TRO

CALIFORNIA PROPOSITION 65 WARNING. This product contains chemicals known to the State of California to cause cancer and birth defects or other reproductive harm.

Design and dimensions are subject to modification. Prices do not include applicable taxes.

Visit [www.mifab.com](http://www.mifab.com) for the most recent product information.

MIFAB®, Inc., 1321 West 119th Street, Chicago, Illinois 60643-5109, USA  
All sales subject to MIFAB's® Terms and Warranties. Please refer to page no. 3.

Toll Free: 1-800-465-2736, Fax: 1-773-341-3049  
sales@mifab.com Canada Toll Free: 1-800-387-3880

**SERIES MFRU**
**UNINSULATED FIRE RATED ACCESS DOOR**

**DESCRIPTION**

The MIFAB® MFRU uninsulated fire rated access door is approved by Underwriters Laboratories Inc., for 1 1/2 hours, "B" label in walls. The door meets ANSI-UL 10B standards. It has a light color finish.

**SPECIFICATIONS**

**Material:** MFRU Series is 16 gauge satin coat steel door and frame. The MFRUSS Stainless Steel Series is 16 gauge #304 stainless steel door and frame.

**Finish:** Satin coat steel doors have a primed finish. Stainless steel doors have a #4 brush satin finish.

**Door:** Flush to frame. Self-closing. Can be opened from the inside or back of the door with MIFAB's unique thumb turn latch.

**Frame:** Four piece welded frame with masonry mounting straps.

**Hinge:** Concealed pivot pins.

**Spring:** Heavy duty.

**Latch:** Standard - Flush mounted, interchangeable turn ring operator and key operator latch.

Optional - cylinder key lock. All of MIFAB's cylinder key locks are keyed alike.

**Fire Rating:** Underwriters Laboratories "B" label. 1 1/2 hour for walls. Insulation not required.

**Packaging:** Individual pack.

\* Custom sized access doors are available. Contact your local MIFAB® representative for a quotation for any size access door you need.

*"I really like the MIFAB universal multi-purpose access doors. I use these for all my concealed shut off valves, water hammer arrestors, hub drains in walls, and sometimes Studor vents. They work well for all my applications."*

— Christopher T. Ramos, Plumbing Designer, Kraemer Consulting Engineers, Phoenix, AZ

"B" x "A"	WALL OPENING	SHIP WEIGHT (Lbs.)	LATCHES	MILD STEEL MODEL #	LIST PRICE MILD STEEL	STAINLESS STEEL MODEL #	LIST PRICE STAINLESS STEEL
8" x 8"	8 1/2" x 8 1/2"	9.0	1	MFRU0808	\$249.00	MFRUSS0808	\$525.00
10" x 10"	10 1/2" x 10 1/2"	10.0	1	MFRU1010	\$255.00	MFRUSS1010	\$539.00
12" x 12"	12 1/2" x 12 1/2"	12.5	1	MFRU1212	\$259.00	MFRUSS1212	\$555.00
12" x 18"	12 1/2" x 18 1/2"	14.5	1	MFRU1218	\$272.00	MFRUSS1218	\$584.00
12" x 24"	12 1/2" x 24 1/2"	17.0	1	MFRU1224	\$289.00	MFRUSS1224	\$615.00
14" x 14"	14 1/2" x 14 1/2"	14.0	1	MFRU1414	\$302.00	MFRUSS1414	\$599.00
16" x 16"	16 1/2" x 16 1/2"	15.0	1	MFRU1616	\$319.00	MFRUSS1616	\$659.00
18" x 18"	18 1/2" x 18 1/2"	19.0	1	MFRU1818	\$337.00	MFRUSS1818	\$674.00
20" x 20"	20 1/2" x 20 1/2"	24.0	1	MFRU2020	\$350.00	MFRUSS2020	\$734.00
22" x 22"	22 1/2" x 22 1/2"	21.5	1	MFRU2222	\$392.00	MFRUSS2222	\$823.00
22" x 30"	22 1/2" x 30 1/2"	31.5	1	MFRU2230	\$494.00	MFRUSS2230	\$945.00
24" x 24"	24 1/2" x 24 1/2"	27.0	1	MFRU2424	\$417.00	MFRUSS2424	\$853.00
24" x 36"	24 1/2" x 36 1/2"	41.5	2	MFRU2436	\$562.00	MFRUSS2436	\$1,092.00
24" x 48"	24 1/2" x 48 1/2"	58.5	2	MFRU2448	\$652.00	MFRUSS2448	\$1,451.00
30" x 30"	30 1/2" x 30 1/2"	40.5	2	MFRU3030	\$575.00	MFRUSS3030	\$1,348.00
32" x 32"	32 1/2" x 32 1/2"	42.5	2	MFRU3232	\$589.00	MFRUSS3232	\$1,348.00
36" x 36"	36 1/2" x 36 1/2"	54.0	2	MFRU3636	\$753.00	MFRUSS3636	\$1,559.00
36" x 48"	36 1/2" x 48 1/2"	72.5	2	MFRU3648	\$876.00	MFRUSS3648	\$1,677.00

The access door construction design (lock and hinge) cannot be changed without affecting the Warnock Hersey and cUL approvals.



California State Fire Marshall Approval #3330-1535:00

**MFRU OPTIONAL VARIATIONS**

SUFFIX	DESCRIPTION	LIST PRICE, EACH
-C	Cylinder key lock	\$43.00

**Note:** The hinge is always furnished on the "A" or height (longer) dimension, unless otherwise specified.

**Note:** Custom sized MFRU Series of access doors cannot exceed 1,728 square inches with the fire rated approval.

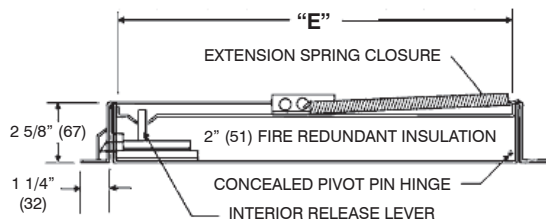

**Key Operator**

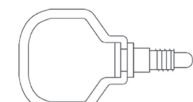

**Turn Ring Operator**

The Key Operator and Turn Ring Operator keys are shipped with every MFRU fire rated access door. If additional keys are required, please order them by Part # KEY-TRO

A-B Door Size C-D Overall Dimensions - Door Size - Plus 2 5/8" (67) E Wall Opening - Door Size - Plus 1/2" (13) (Allow an extra 1/4" (6) clearance for latch housing on "D" side.)

CALIFORNIA PROPOSITION 65 WARNING. This product contains chemicals known to the State of California to cause cancer and birth defects or other reproductive harm.

**SERIES MPFR-DW INSULATED FIRE RATED ACCESS DOOR WITH DRYWALL BEAD FRAME**
**DESCRIPTION**

The MIFAB® MPFR-DW fire rated access door is approved by Underwriters Laboratories Inc., for 1 1/2 hours, "B" label in walls and is approved by Warnock Hersey for 2 hours in ceilings and 3 hours in walls. It meets ANSI-UL 10B standards. The same door can be used in walls and ceilings. Tests were conducted using mild steel and Type 304 stainless steel. The MPFR-DW incorporates a drywall bead type of frame for a concealed frame application.

**SPECIFICATIONS**

**Material:** MPFR-DW Series is 16 gauge satin coat steel front door with 20 gauge backliner and 16 gauge satin coat steel frame. The MPFR-DWSS Stainless Steel Series is 16 gauge #304 stainless steel front door with 20 gauge backliner and 16 gauge #304 stainless steel frame.

**Finish:** Satin coat steel doors have a primed finish. Stainless steel doors have a #4 brush satin finish.

**Door:** Flush to frame. Self-closing. Can be opened from the inside or back of the door with MIFAB's unique thumb-turn latch.

**Frame:** Four piece welded frame with masonry mounting straps and drywall bead frame for concealed drywall applications.

**Hinge:** Concealed pivot pins.

**Spring:** Heavy duty. An extra spring is provided with every door greater than 14" x 14" (356 x 356) for ceiling installation. Both springs must be attached to the door to ensure that the door will close when installed in the ceiling.

**Latch:** Standard - Flush mounted, interchangeable turn-ring operator and key-operator latch. Optional - cylinder key lock. All of MIFAB's cylinder key locks are keyed alike.

**Fire Rating:** Underwriters Laboratories "B" label. 1½ hours for walls. Warnock Hersey: 1 hour combustible ceilings and walls, 2 hour non-combustible ceilings and 3 hour noncombustible walls. Ceiling fire ratings are up to and including the 24" x 36" (610 x 914) size.

**Insulation:** Roxul Rockboard 80. 2" (50) thick and fire retardant.

**Packaging:** Individual pack.



\* Custom sized access doors are available. Contact your local MIFAB® representative for a quotation for any size access door you need.

"B" x "A"	WALL OPENING	SHIP WEIGHT (Lbs.)	LATCHES	MILD STEEL MODEL #	LIST PRICE MILD STEEL	STAINLESS STEEL MODEL #	LIST PRICE STAINLESS STEEL
8" x 8"	8 1/2" x 8 1/2"	10.0	1	MPFR-DW0808	\$503.00	MPFR-DWSS0808	\$1,235.00
10" x 10"	10 1/2" x 10 1/2"	12.0	1	MPFR-DW1010	\$503.00	MPFR-DWSS1010	\$1,259.00
12" x 12"	12 1/2" x 12 1/2"	14.0	1	MPFR-DW1212	\$516.00	MPFR-DWSS1212	\$1,279.00
12" x 18"	12 1/2" x 18 1/2"	16.0	1	MPFR-DW1218	\$639.00	MPFR-DWSS1218	\$1,553.00
12" x 24"	12 1/2" x 24 1/2"	19.0	1	MPFR-DW1224	\$679.00	MPFR-DWSS1224	\$1,525.00
14" x 14"	14 1/2" x 14 1/2"	15.5	1	MPFR-DW1414	\$547.00	MPFR-DWSS1414	\$1,372.00
16" x 16"	16 1/2" x 16 1/2"	16.5	1	MPFR-DW1616	\$639.00	MPFR-DWSS1616	\$1,553.00
18" x 18"	18 1/2" x 18 1/2"	19.0	1	MPFR-DW1818	\$666.00	MPFR-DWSS1818	\$1,613.00
20" x 20"	20 1/2" x 20 1/2"	24.0	1	MPFR-DW2020	\$758.00	MPFR-DWSS2020	\$1,675.00
22" x 22"	22 1/2" x 22 1/2"	28.0	1	MPFR-DW2222	\$865.00	MPFR-DWSS2222	\$1,692.00
22" x 30"	22 1/2" x 30 1/2"	35.0	2	MPFR-DW2230	\$1,290.00	MPFR-DWSS2230	\$2,327.00
24" x 24"	24 1/2" x 24 1/2"	30.0	1	MPFR-DW2424	\$989.00	MPFR-DWSS2424	\$1,778.00
24" x 36"	24 1/2" x 36 1/2"	46.0	2	MPFR-DW2436	\$1,442.00	MPFR-DWSS2436	\$2,410.00
24" x 48"	24 1/2" x 48 1/2"	65.0	2	MPFR-DW2448	\$1,684.00	MPFR-DWSS2448	\$2,674.00
30" x 30"	30 1/2" x 30 1/2"	45.0	1	MPFR-DW3030	\$1,442.00	MPFR-DWSS3030	\$2,290.00
32" x 32"	32 1/2" x 32 1/2"	47.0	1	MPFR-DW3232	\$1,546.00	MPFR-DWSS3232	\$3,230.00
36" x 36"	36 1/2" x 36 1/2"	60.0	2	MPFR-DW3636	\$1,684.00	MPFR-DWSS3636	\$3,535.00
36" x 48"	36 1/2" x 48 1/2"	80.0	2	MPFR-DW3648	\$1,842.00	MPFR-DWSS3648	\$4,692.00

The access door construction design (lock and hinge) cannot be changed without affecting the Warnock Hersey and cUL approvals.

**Warnock Hersey**



California State  
Fire Marshall  
Approval #  
3330-1535:00

**MPFR-DW OPTIONAL VARIATIONS**

SUFFIX	DESCRIPTION	LIST PRICE, EACH
-C	Cylinder key lock	\$43.00

**Note:** The hinge is always furnished on the "A" or height (longer) dimension, unless otherwise specified.

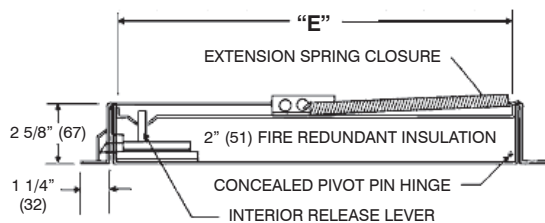
**Note:** Custom sized MPFR-DW Series of access doors cannot exceed 1,728 square inches with the fire rated approval.

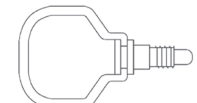

A-B Door Size C-D Overall Dimensions - Door Size - Plus 2 5/8" (67) E Wall Opening - Door Size - Plus 1/2" (13) (Allow an extra 1/4" (6) clearance for latch housing on "D" side.)

**Key Operator**

**Turn Ring Operator**

The Key Operator and Turn Ring Operator keys are shipped with every MPFR-DW fire rated access door. If additional keys are required, please order them by Part # KEY-TRO

CALIFORNIA PROPOSITION 65 WARNING. This product contains chemicals known to the State of California to cause cancer and birth defects or other reproductive harm.

Design and dimensions are subject to modification. Prices do not include applicable taxes.

Visit [www.mifab.com](http://www.mifab.com) for the most recent product information.

MIFAB®, Inc., 1321 West 119th Street, Chicago, Illinois 60643-5109, USA

Toll Free: 1-800-465-2736, Fax: 1-773-341-3049

All sales subject to MIFAB's® Terms and Warranties. Please refer to page no. 3.

sales@mifab.com Canada Toll Free: 1-800-387-3880

**SERIES MI-SAD**
**MEDIUM SECURITY ACCESS DOOR**

**DESCRIPTION**

The MIFAB® MI-SAD medium security access door is designed for drywall, masonry, or concrete construction, providing the security required in today's schools, hospitals, hotels, and correctional institutions. It has a light color finish.

**SPECIFICATIONS**

**Material:** MI-SAD Series is 12 gauge steel door and 3/16" angle steel frame. The MI-SADSS Stainless Steel Series is 12 gauge #304 stainless steel door and 3/16" (4) angle stainless steel frame.

**Finish:** Satin coat steel doors have a primed finish. Stainless steel doors have a #4 brush satin finish.

**Door:** Flush to frame.

**Frame:** 3/16" (4) x 1 1/2" (38) x 1 1/2" (38) angle steel, angle welded with joints ground smooth. The frame has pre-punched 3/16" (4) mounting holes for easy installation.

**Hinge:** Two heavy duty butt hinges welded to the door and frame.

**Latch:** Standard - Cylinder key lock. All of MIFAB's cylinder key locks are keyed alike.

**Packaging:** Individual pack.

\* Custom sized access doors are available. Contact your local MIFAB® representative for a quotation for any size access door you need.

*"MIFAB access doors are high quality and competitively priced and my Rep has local inventory which makes it very easy to get product when we need it!"*

- Cindy Snyder, Project Manager/Partner, City Commercial Plumbing, Lake Balboa, CA

"B" x "A"	WALL OPENING	SHIP WEIGHT (Lbs.)	LATCHES	LENGTH	WIDTH	MILD STEEL MODEL #	LIST PRICE MILD STEEL	STAINLESS STEEL MODEL #	LIST PRICE STAINLESS STEEL
8" x 8"	8-1/2" x 8-1/2"	10.0	1	8	8	MI-SAD0808	\$720.00	MI-SADSS0808	\$988.00
10" x 10"	10-1/2" x 10-1/2"	11.0	1	10	10	MI-SAD1010	\$739.00	MI-SADSS1010	\$1,066.00
12" x 12"	12-1/2" x 12-1/2"	17.0	1	12	12	MI-SAD1212	\$760.00	MI-SADSS1212	\$1,151.00
14" x 14"	14-1/2" x 14-1/2"	20.0	1	14	14	MI-SAD1414	\$784.00	MI-SADSS1414	\$1,244.00
16" x 16"	16-1/2" x 16-1/2"	24.0	1	16	16	MI-SAD1616	\$809.00	MI-SADSS1616	\$1,345.00
18" x 18"	18-1/2" x 18-1/2"	28.0	1	18	18	MI-SAD1818	\$836.00	MI-SADSS1818	\$1,454.00
18" x 24"	18-1/2" x 24-1/2"	34.0	1	18	24	MI-SAD1824	\$878.00	MI-SADSS1824	\$1,623.00
22" x 22"	22-1/2" x 22-1/2"	37.0	1	22	22	MI-SAD2222	\$896.00	MI-SADSS2222	\$1,695.00
24" x 24"	24-1/2" x 24-1/2"	41.0	1	24	24	MI-SAD2424	\$1,091.00	MI-SADSS2424	\$1,990.00
24" x 30"	24-1/2" x 30-1/2"	50.0	1	24	30	MI-SAD2430	\$1,142.00	MI-SADSS2430	\$2,194.00
24" x 36"	24-1/2" x 36-1/2"	56.0	2	24	36	MI-SAD2436	\$1,194.00	MI-SADSS2436	\$2,398.00
30" x 30"	30-1/2" x 30-1/2"	60.0	2	30	30	MI-SAD3030	\$1,202.00	MI-SADSS3030	\$2,433.00
36" x 36"	36-1/2" x 36-1/2"	75.0	2	36	36	MI-SAD3636	\$1,331.00	MI-SADSS3636	\$2,948.00

**SERIES MI-SADH**
**HIGH SECURITY ACCESS DOOR**

**DESCRIPTION**

The MIFAB® MI-SADH high security access door is designed to provide security access, with the strength and durability to endure abusive and vandal-prone conditions, common in many institutions. It has a light color finish.

**SPECIFICATIONS**

**Material:** MI-SADH Series is 10 gauge steel door and 1/4" angle steel frame. The MI-SADHSS Stainless Steel Series is 10 gauge #304 stainless steel door and 1/4" (6) angle stainless steel frame.

**Finish:** Steel doors have a primed finish. Stainless steel doors have a #4 brush satin finish.

**Door:** Flush to frame.

**Frame:** 1/4" x 2" x 2" (6 x 50 x 50) angle steel, angle welded with joints ground smooth. The frame has pre-punched 1/4" (6) mounting holes for easy installation.

**Hinge:** Two heavy duty butt hinges welded to the door and frame.

**Latch:** Standard - Best Lock #1E7D4-C228-RP3-626 with key. Optional - locks provided by others.

**Packaging:** Individual pack.

\* Custom sized access doors are available. Contact your local MIFAB® representative for a quotation for any size access door you need.

"B" x "A"	WALL OPENING	SHIP WEIGHT (Lbs.)	LATCHES	MILD STEEL MODEL #	LIST PRICE MILD STEEL	STAINLESS STEEL MODEL #	LIST PRICE STAINLESS STEEL
12" x 12"	12-1/2" x 12-1/2"	22.0	1	MI-SADH1212	\$3,267.00	MI-SADHSS1212	\$4,887.00
16" x 16"	16-1/2" x 16-1/2"	31.0	1	MI-SADH1616	\$3,435.00	MI-SADHSS1616	\$5,232.00
18" x 18"	18-1/2" x 18-1/2"	37.0	1	MI-SADH1818	\$3,467.00	MI-SADHSS1818	\$5,951.00
24" x 24"	24-1/2" x 24-1/2"	55.0	1	MI-SADH2424	\$3,586.00	MI-SADHSS2424	\$6,667.00
24" x 36"	24-1/2" x 36-1/2"	73.5	2	MI-SADH2436	\$3,659.00	MI-SADHSS2436	\$7,931.00
24" x 48"	24-1/2" x 48-1/2"	88.0	2	MI-SADH2448	\$3,991.00	MI-SADHSS2448	\$8,506.00
36" x 36"	36-1/2" x 36-1/2"	97.5	2	MI-SADH3636	\$4,130.00	MI-SADHSS3636	\$9,510.00
36" x 48"	36-1/2" x 48-1/2"	120.0	2	MI-SADH3648	\$4,196.00	MI-SADHSS3648	\$12,816.00

CALIFORNIA PROPOSITION 65 WARNING. This product contains chemicals known to the State of California to cause cancer and birth defects or other reproductive harm.



**SERIES MI-FVP FLUSH VALVE PANEL**
**DESCRIPTION**

The MIFAB® MI-FVP flush valve panel is designed for back supply toilets and urinals where the flush valve is built into the wall. This panel allows easy access to service the flush valve by maintenance personnel. The panel provides protection to the flush valve from vandalism.

**SPECIFICATIONS**

**Material:** MI-FVP Series is 16 gauge satin coat steel door and 16 gauge satin coat steel frame. The MI-FVPSS Stainless Steel Series is 16 gauge #304 stainless steel door and frame.

**Finish:** Steel doors have a primed finish. Stainless steel doors have a #4 brush satin finish.

**Door:** Has a 1½" (38) diameter hole in the center of the panel for the flush valve push button. Optional - solid door with no hole in the middle - Suffix "-NH".

**Frame:** Two piece construction with 5/16" x 11/16" (8 x 17.5) OBL Slots for easy installation.

**Latch:** Four 1/4" (6) - 20 x 1" (25) tamper resistant stainless steel Torx screws.

**Packaging:** Individual pack.

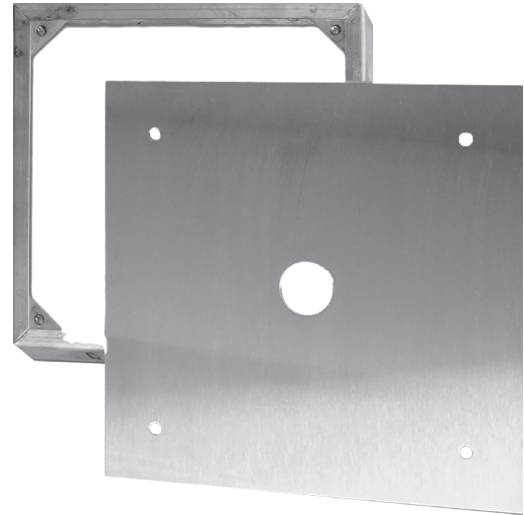

\* Custom sized access doors are available. Contact your local MIFAB® representative for a quotation for any size access door you need.

"B" x "A"	DOOR SIZE	WALL OPENING	SHIPPING WEIGHT (Lbs.)	MILD STEEL MODEL #	LIST PRICE MILD STEEL	STAINLESS STEEL MODEL #	LIST PRICE STAINLESS STEEL
MI-FVP-1	12" x 12"	10 1/2" x 10 1/2"	6.0	MI-FVP1212	\$202.00	MI-FVPSS1212	\$731.00
MI-FVP-2	13" x 17"	11 1/2" x 15 1/2"	7.0	MI-FVP1317	\$258.00	MI-FVPSS1317	\$982.00

**SERIES MI-SF SURFACE ACCESS DOOR**
**DESCRIPTION**

The MIFAB® MI-SF surface access door is designed for surface installation on drywall, masonry, or thin-coat plaster. The door is attached to the frame with a continuous piano hinge allowing 175 degree opening. It has a light color finish.

**SPECIFICATIONS**

**Material:** MI-SF Series is 16 gauge steel door and frame. The MI-SFSS Stainless Steel Series is 16 gauge #304 stainless steel door and frame.

**Finish:** Satin coat steel doors have a primed finish. Stainless steel doors have a #4 brush satin finish.

**Door:** Flush to frame. One 1/4" (6) hole in each corner. A 3/8" (9) wide outer perimeter space of the frame is bent on a fifteen degree angle toward the wall.

**Hinge:** Continuous piano hinge. 175 degree opening.

**Latch:** Standard – Flush mounted, screwdriver operated cam. Optional – Allen key, cylinder key, or Vandal resistant (lock only) latch. All of MIFAB's cylinder key locks are keyed alike.

**Packaging:** Individual pack.

\* Custom sized access doors are available. Contact your local MIFAB® representative for a quotation for any size access door you need.



"B" x "A"	SHIP WEIGHT (Lbs.)	LATCHES	MILD STEEL MODEL #	LIST PRICE MILD STEEL	STAINLESS STEEL MODEL #	LIST PRICE STAINLESS STEEL
8" x 8"	2.5	1	MI-SF0808	\$83.00	MI-SFSS0808	\$270.00
10" x 10"	3.5	1	MI-SF1010	\$92.00	MI-SFSS1010	\$296.00
12" x 12"	4.0	1	MI-SF1212	\$114.00	MI-SFSS1212	\$366.00
14" x 14"	6.0	1	MI-SF1414	\$133.00	MI-SFSS1414	\$438.00
16" x 16"	8.0	1	MI-SF1616	\$166.00	MI-SFSS1616	\$537.00
18" x 18"	9.5	3	MI-SF1818	\$202.00	MI-SFSS1818	\$666.00
22" x 22"	13.5	3	MI-SF2222	\$252.00	MI-SFSS2222	\$823.00
24" x 24"	16.0	3	MI-SF2424	\$288.00	MI-SFSS2424	\$940.00

**MI-SF OPTIONAL VARIATIONS**

SUFFIX	DESCRIPTION	LIST PRICE, EACH
-A	Allen key lock	\$31.00
-C	Cylinder key lock	\$43.00
-VP	Vandal resistant (lock only)	\$105.00

**NOTE:** The hinge is always furnished on the "A" or height (longer) dimension, unless otherwise specified.

CALIFORNIA PROPOSITION 65 WARNING. This product contains chemicals known to the State of California to cause cancer and birth defects or other reproductive harm.

Design and dimensions are subject to modification. Prices do not include applicable taxes.

Visit [www.mifab.com](http://www.mifab.com) for the most recent product information.

MIFAB®, Inc., 1321 West 119th Street, Chicago, Illinois 60643-5109, USA  
All sales subject to MIFAB's® Terms and Warranties. Please refer to page no. 3.

Toll Free: 1-800-465-2736, Fax: 1-773-341-3049  
sales@mifab.com Canada Toll Free: 1-800-387-3880

**SERIES MI-VB, MI-VB-SM VALVE BOX**

**DESCRIPTION**

The MIFAB® MI-VB valve box is designed to provide easy access to all types of valves and controls that are concealed in the wall and need to be protected by a fully enclosed box. The MIFAB® MI-VB-SM valve box is designed to provide easy access to all types of valves and controls that extend outside of the finished wall and need to be protected by a fully enclosed box. The depth of all valve boxes can be customized to meet any rough in requirements.

**SPECIFICATIONS**

**Material:** MI-VB Series is a 16 gauge satin coat steel door and frame and a 20 gauge satin coat steel box. The MI-VB-SM is 16 gauge satin coat steel door and box. The MI-VBSS is a 16 gauge #304 stainless steel door and frame with a 20 gauge #304 stainless steel box. The MI-VB-SMSS is a 16 gauge #304 stainless steel door and box.

**Finish:** All Satin Coat VB's have a primed finish. MI-VBSS has a #4 brush satin finish on door and frame and a 2B finish on the box. MI-VB-SMSS has a #4 brush satin finish on door as well as the box.

**Door:** MI-VB Series - flush to frame. Turned back around edges for extra rigidity. MI-VB-SM Series - overlaps box, providing a tight secure fit. Optional - opening cut out of door to allow for glass or plastic window to be installed - window material supplied by others.

**Frame:** MI-VB Series - pre-punched mounting holes for simple installation. It is welded to the box.

**Hinge:** Concealed pivot pins.

**Latch:** Standard - Flush mounted, screwdriver operated cam. Optional - Allen key, cylinder key, or paddle latch. All of MIFAB's cylinder key locks are keyed alike.

**Packaging:** Individual pack.



MI-VB-SM with optional cut out of door to allow for glass or plastic window by others.

**(Illustrated) (Suffix -CO) \$205.00, List Price**

**MI-VB, MI-VB-SM OPTIONAL VARIATIONS**

SUFFIX	DESCRIPTION	LIST PRICE, EACH
-A	Allen key lock	\$31.00
-C	Cylinder key lock	\$43.00
-CO	Cut out in middle of door	\$205.00
-PL	Paddle latch	\$105.00
-VP	Vandal resistant (lock only)	\$105.00
-WR	Water resistant	\$166.00

**NOTE:** The hinge is always furnished on the "A" or height (longer) dimension, unless otherwise specified.

\* Custom sized access doors are available. Contact your local MIFAB® representative for a quotation for any size access door you need.

**MI-VB SERIES (RECESSED)**

"B" x "A"	DOOR SIZE	SHIPPING WEIGHT (Lbs.)	LATCHES	MILD STEEL MODEL #	LIST PRICE MILD STEEL	STAINLESS STEEL MODEL #	LIST PRICE STAINLESS STEEL
8" x 8" x 4"	8" x 8" x 4"	10.0	1	MI-VB080804	\$344.00	MI-VBSS080804	\$754.00
8" x 8" x 6"	8" x 8" x 6"	12.0	1	MI-VB080806	\$373.00	MI-VBSS080806	\$849.00
8" x 8" x 8"	8" x 8" x 8"	14.0	1	MI-VB080808	\$406.00	MI-VBSS080808	\$947.00
12" x 12" x 4"	12" x 12" x 4"	18.0	1	MI-VB121204	\$430.00	MI-VBSS121204	\$973.00
12" x 12" x 6"	12" x 12" x 6"	20.0	1	MI-VB121206	\$462.00	MI-VBSS121206	\$1,036.00
12" x 12" x 8"	12" x 12" x 8"	24.0	1	MI-VB121208	\$480.00	MI-VBSS121208	\$1,119.00
14" x 14" x 4"	14" x 14" x 4"	26.0	1	MI-VB141404	\$531.00	MI-VBSS141404	\$1,223.00
14" x 14" x 6"	14" x 14" x 6"	28.0	1	MI-VB141406	\$562.00	MI-VBSS141406	\$1,255.00
14" x 14" x 8"	14" x 14" x 8"	30.0	1	MI-VB141408	\$598.00	MI-VBSS141408	\$1,313.00
16" x 16" x 4"	16" x 16" x 4"	32.0	1	MI-VB161604	\$640.00	MI-VBSS161604	\$1,470.00
16" x 16" x 6"	16" x 16" x 6"	34.0	1	MI-VB161606	\$672.00	MI-VBSS161606	\$1,545.00
16" x 16" x 8"	16" x 16" x 8"	36.0	1	MI-VB161608	\$709.00	MI-VBSS161608	\$1,629.00

**MI-VB-SM SERIES (SURFACE MOUNTED)**

"B" x "A"	DOOR SIZE	SHIPPING WEIGHT (Lbs.)	LATCHES	MILD STEEL MODEL #	LIST PRICE MILD STEEL	STAINLESS STEEL MODEL #	LIST PRICE STAINLESS STEEL
8" x 8" x 4"	8" x 8" x 4"	10.0	1	MI-VB-SM080804	\$344.00	MI-VB-SMSS080804	\$754.00
8" x 8" x 6"	8" x 8" x 6"	12.0	1	MI-VB-SM080806	\$373.00	MI-VB-SMSS080806	\$849.00
8" x 8" x 8"	8" x 8" x 8"	14.0	1	MI-VB-SM080808	\$406.00	MI-VB-SMSS080808	\$947.00
12" x 12" x 4"	12" x 12" x 4"	18.0	1	MI-VB-SM121204	\$430.00	MI-VB-SMSS121204	\$973.00
12" x 12" x 6"	12" x 12" x 6"	20.0	1	MI-VB-SM121206	\$462.00	MI-VB-SMSS121206	\$1,036.00
12" x 12" x 8"	12" x 12" x 8"	24.0	1	MI-VB-SM121208	\$480.00	MI-VB-SMSS121208	\$1,119.00
14" x 14" x 4"	14" x 14" x 4"	26.0	1	MI-VB-SM141404	\$531.00	MI-VB-SMSS141404	\$1,223.00
14" x 14" x 6"	14" x 14" x 6"	28.0	1	MI-VB-SM141406	\$562.00	MI-VB-SMSS141406	\$1,255.00
14" x 14" x 8"	14" x 14" x 8"	30.0	1	MI-VB-SM141408	\$598.00	MI-VB-SMSS141408	\$1,313.00
16" x 16" x 4"	16" x 16" x 4"	32.0	1	MI-VB-SM161604	\$640.00	MI-VB-SMSS161604	\$1,470.00
16" x 16" x 6"	16" x 16" x 6"	34.0	1	MI-VB-SM161606	\$672.00	MI-VB-SMSS161606	\$1,545.00
16" x 16" x 8"	16" x 16" x 8"	36.0	1	MI-VB-SM161608	\$709.00	MI-VB-SMSS161608	\$1,629.00

CALIFORNIA PROPOSITION 65 WARNING. This product contains chemicals known to the State of California to cause cancer and birth defects or other reproductive harm.

**SERIES PA**
**PLASTIC ACCESS DOOR**
**DESCRIPTION**

The MIFAB® PA plastic access door is designed to provide easy access to plumbing and cables behind walls and ceilings. The door is removable from the frame and fits tightly with snap latches. The finish can be painted or wallpapered or left as is to match the surrounding environment. This door should not be installed near any existing or potential source of excessive heat or open flame.

**SPECIFICATIONS**

**Material:** PA Series is made of 1/8" (3) thick high impact styrene plastic with U.V. stabilizers to prevent fading and corrosion.  
**Finish:** Light color.  
**Door:** Flush to frame - rounded safety corners. Two pull tabs on the back of the door allow door to be pulled back into the frame from behind walls and ceilings.  
**Frame:** One piece outside flange that is 1 1/2" (38) wide with a 5/8" deep mounting flange.  
**Latch:** Snap latches allow door to fit tightly into frame.  
**Packaging:** 8" x 8" (203 x 203) and 14" x 14" (356 x 356) doors are packed 15 per carton and the 14" x 29" (356 x 736) doors are packed 5 per carton.



MODEL #	PA SERIES	WALL OPENING	SHIPPING WEIGHT (Lbs.) (UNIT)	SHIPPING WEIGHT (Lbs.) (CARTON)	LIST PRICE, EACH
PA0808	8" x 8"	7 7/8" x 7 7/8"	0.75	14	\$63.00
PA1414	14" x 14"	13 7/8" x 13 7/8"	1.75	30	\$69.00
PA1429	14" x 29"	13 7/8" x 28 7/8"	2.90	17	\$150.00

**SERIES FHA, FHG**
**FLOOR ACCESS DOOR**
**DESCRIPTION**

The MIFAB Series FHA and FHG floor access doors are for interior and exterior use where easy access is required. The angle frame construction with integral anchor flange is designed to be cast into concrete. They are available in either an acid resistant, powder epoxy coated steel finish (grey color) (FHG) or aluminum (FHA). Standard units withstand load bearing of 300 lbs. per square foot. They are designed for safety, durability and ease of operation.

**SPECIFICATIONS**

**Material:** FHG Series has a door made of 3/16" (5 mm) thick A36 diamond plate. FHA Series has a door made of 3/16" (5) thick structural grade aluminum diamond plate. Both doors can support 300 lbs. per square foot live load. Frame material is composite hot rolled steel angle frame.  
**Finish:** FHG Series has an acid resistant, powder epoxy coated grey finish. FHA Series is an aluminum mill finish. Frame is finished with a bituminous coating.  
**Door:** Flush to frame. Equipped with an automatically locking hold open arm that locks the door in the open position. Also available are 1/4" (6 mm) thick doors reinforced to meet a 10,000 lb. load rating. (without impact for the FHA Series)  
**Frame:** Complete with a 1" (25 mm) anchor flange. All hardware is Type # 316 stainless steel.  
**Hinge:** Tamper proof steel hinges with stainless steel pins.  
**Opening Device:** Automatic locking hold open arm with red vinyl grip allows door to open 90 degrees.  
**Handle:** Stainless steel recessed lift handle in the door.  
**Latch:** The following lock options are available: padlock staple, Type # 316 stainless steel snap lock with removable handle, recessed hasp, Type # 316 stainless steel pentahead, keyed deadbolt lock with removable handle, recessed hasp, Type # 316 stainless steel pentahead, keyed deadbolt lock with removable handle, recessed hasp and staple. The standard latch used is the compression lever latch (illustrated below).  
**Packaging:** Individual pack.

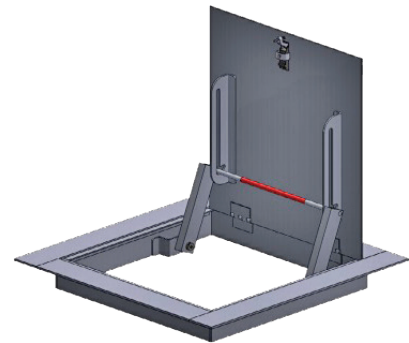

*"MIFAB's everyday access doors are high quality. They even have the ability to custom fabricate doors to my needs."*  
 - Artie Maynard, Manager, Vrabel Plumbing, Gibsonia, PA

"B" x "A"	FLOOR OPENING	FHA SHIPPING WT. (Lbs.)	FHG SHIPPING WT. (Lbs.)	FHG MODEL #	FHG LIST PRICE	ALUMINUM MODEL #	FHA LIST PRICE (ALUMINUM)
24" x 24"	24-1/2" x 24-1/2"	42	90	FHG2424	\$2,424.00	FHA2424	\$2,953.00
24" x 30"	24-1/2" x 30-1/2"	49	105	FHG2430	\$2,785.00	FHA2430	\$3,410.00
24" x 36"	24-1/2" x 36-1/2"	55	120	FHG2436	\$2,924.00	FHA2436	\$3,890.00
30" x 30"	30-1/2" x 30-1/2"	56	122	FHG3030	\$3,312.00	FHA3030	\$6,219.00
30" x 36"	30-1/2" x 36-1/2"	64	138	FHG3036	\$3,402.00	FHA3036	\$6,611.00
30" x 48"	30-1/2" x 48-1/2"	78	172	FHG3048	\$4,326.00	FHA3048	\$7,299.00
36" x 36"	36-1/2" x 36-1/2"	72	156	FHG3636	\$4,591.00	FHA3636	\$7,794.00
36" x 48"	36-1/2" x 48-1/2"	89	194	FHG3648	\$5,004.00	FHA3648	\$8,545.00
42" x 42"	42-1/2" x 42-1/2"	90	196	FHG4242	\$4,808.00	FHA4242	\$7,913.00
48" x 48"	48-1/2" x 48-1/2"	108	240	FHG4848	\$5,949.00	FHA4848	\$8,515.00
48" x 72"	48-1/2" x 72-1/2"	150	332	FHG4872	\$9,845.00	FHA4872	\$12,539.00
60" x 60"	60-1/2" x 60-1/2"	155	340	FHG6060	\$12,143.00	FHA6060	\$14,918.00



Compression Lever Latch (Standard latch used)

- Optional Accessories:**
- Compression Spring Assist
  - Skirting to Depth of Slab
  - Fibreglass Insulation

To determine the floor opening for doors with a Recess Frame (Suffix -RF), add 6" to the "B" x "A" (Door Opening) dimensions in the above chart. (Dimension) Denotes Millimetres. Note: The hinge is always furnished on the "A" or height (longer) dimension, unless otherwise specified. Example: the model number would be FHG4872 for a floor access door with the hinge on the longer (72") dimension. The model number would be FHG7248 for a floor access door with the hinge on the shorter (48") dimension.

CALIFORNIA PROPOSITION 65 WARNING. This product contains chemicals known to the State of California to cause cancer and birth defects or other reproductive harm.

Design and dimensions are subject to modification. Prices do not include applicable taxes. Visit [www.mifab.com](http://www.mifab.com) for the most recent product information.

MIFAB®, Inc., 1321 West 119th Street, Chicago, Illinois 60643-5109, USA  
 All sales subject to MIFAB's® Terms and Warranties. Please refer to page no. 3.

Toll Free: 1-800-465-2736, Fax: 1-773-341-3049  
 sales@mifab.com Canada Toll Free: 1-800-387-3880

**SERIES RHA, RHG ROOF HATCH**

**Note:** MIFAB® can supply mounting points for any additional accessories.

**DESCRIPTION**

The MIFAB® Series RHA and RHG roof hatches are designed to provide convenient, economical access to the roofs of buildings. They are available in either prime coated galvanized steel (RHG) or aluminum (RHA). All hatches are designed with weather resistant gasketing to ensure long life, low maintenance and ease of operation. Roof hatches install easily over the roof opening and are secured from the base flange to the roof deck.

**SPECIFICATIONS**

**Material:** RHG cover is 14 gauge galvanized steel and 20 gauge steel liner. RHA cover is .090" aluminum with a .050 aluminum liner. The inside of the cover is gasketed with a neoprene weather seal to provide a flush, tight, fit. Covers are insulated with 1" (25) of fibreboard and are designed to support a snow load of 40 lbs. per square foot. The frame for the RHG Series is 14 gauge galvanized steel and the frame for the RHA Series is .090" aluminum.

**Curb:** Curbs are 12" (305) high with 4" (102) wide rounded corner flashing flange complete with 1" (25) fibreboard insulation.

**Hinge:** Formed steel hinges with stainless steel pins.

**Finish:** RHG Series is a primed finish. RHA Series is an aluminum mill finish.

**Opening:** Hydraulic column operators allow cover to open and close easily.

**Device:** Cover is equipped with an automatic hold open arm with a red vinyl grip release that keeps the cover in an open position when needed, and allows for easy control when lowering the latch cover.

**Handle:** Self latching outside cadmium plated steel turn handle with inside lever handle allows cover to always latch securely.

**Latch:** Locking hasps are located both inside and outside of the cover. All hardware is cadmium plated steel.

*"I buy MIFAB because of their large selection of access door options, competitive pricing, and high quality!"*

– Adam Chew, Manager, Ferguson, Madison, WI

"B" x "A"	INSIDE FRAME DIM.	OUTSIDE FRAME DIM.	ROOF OPENING	SHIPPING WEIGHT RHG (Lbs.)	GALVANIZED MODEL #	RHG LIST PRICE (GALVANIZED)	SHIPPING WEIGHT RHA (Lbs.)	ALUMINUM MODEL #	RHA LIST PRICE (ALUMINUM)
24" x 24"	24" x 24"	31" x 31"	24" x 24"	125	RHG2424	\$2,746.00	60	RHA2424	\$2,798.00
24" x 30"	24" x 30"	31" x 37"	24" x 30"	130	RHG2430	\$2,899.00	65	RHA2430	\$2,950.00
24" x 36"	24" x 36"	31" x 43"	24" x 36"	135	RHG2436	\$2,998.00	70	RHA2436	\$3,037.00
30" x 30"	30" x 30"	37" x 37"	30" x 30"	145	RHG3030	\$3,118.00	80	RHA3030	\$3,588.00
30" x 36"	30" x 36"	37" x 43"	30" x 36"	155	RHG3036	\$3,400.00	85	RHA3036	\$3,798.00
30" x 54"	30" x 54"	37" x 61"	30" x 54"	225	RHG3054	\$3,714.00	135	RHA3054	\$4,132.00
30" x 96"	30" x 96"	37" x 103"	30" x 96"	335	RHG3096	\$7,176.00	245	RHA3096	\$8,978.00
36" x 36"	36" x 36"	43" x 43"	36" x 36"	200	RHG3636	\$4,434.00	110	RHA3636	\$9,995.00
36" x 48"	36" x 48"	43" x 55"	36" x 48"	430	RHG3648	\$6,598.00	270	RHA3648	\$10,796.00
48" x 48"	48" x 48"	55" x 55"	48" x 48"	430	RHG4848	\$7,141.00	305	RHA4848	\$11,595.00

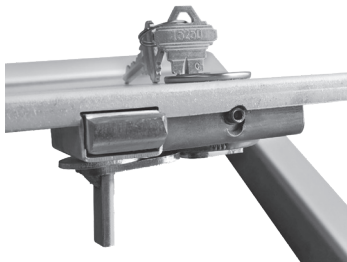
**LOCKS AND LATCHES**

**Mortise Prep Cylinder Lock** - (MIFAB can cut an opening into the door panel to accept any lock requested by the customer.  
**Note:** illustration is with lock and key but this is always provided by others. \$229.00 List Price, each. For the MPFR Series, the lock must be installed by MIFAB during the production process. (It cannot be installed later.)  
 (Part # 1E7D4-C228-RP3-626)

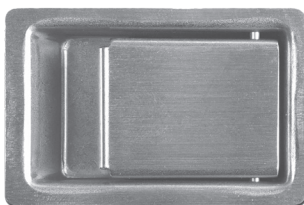

**Paddle Latch**  
 (Suffix -PL)  
 (\$105.00 List Price, each)  
 (Part # PADDLE-LATCH)



**Vandal resistant (lock only)**  
 (Torx screw) (Suffix -VP)  
 (\$105.00 List Price, each)  
 Torx screwdriver is not included.  
 (Part # H-1031B)  
 (List Price - \$125.00)



**Allen Key Lock** (Suffix -A)  
 (\$31.00 List Price, each)  
 (Part # ALLEN-LOCK)



**Flat Head Screw Driver Operated Cam Latch** (Standard)  
 (Part # SCREW-DRIVER-LOCK)



**Cylinder Lock and Key**  
 (Suffix -C)  
 (All of MIFAB's cylinder key locks are keyed alike)  
 (\$43.00 List Price, each)  
 (Part # CYL-KEY-LOCK)  
 (Part # for the key only is CYL-KEY. List Price for the key only is \$32.00)

CALIFORNIA PROPOSITION 65 WARNING. This product contains chemicals known to the State of California to cause cancer and birth defects or other reproductive harm.



**SERIES WID**
**EXTERIOR ACCESS DOOR/WALK-IN DOOR**
**WID Series with 1" Insulation Thickness**

"B" x "A"	SHIPPING WEIGHT (Lbs.)	LATCHES	GALVANIZED MODEL #	GALVANIZED LIST PRICE	STAINLESS STEEL MODEL #	LIST PRICE STAINLESS STEEL	INSULATION THICKNESS
12" x 12"	15.00	1	WID1.0-1212	\$977.00	WIDSS1.0-1212	\$1,829.00	1"
12" x 24"	23.00	2	WID1.0-1224	\$1,269.00	WIDSS1.0-1224	\$2,374.00	1"
14" x 14"	17.00	1	WID1.0-1414	\$1,056.00	WIDSS1.0-1414	\$1,983.00	1"
16" x 16"	18.50	1	WID1.0-1616	\$1,165.00	WIDSS1.0-1616	\$2,072.00	1"
16" x 20"	20.00	1	WID1.0-1620	\$1,269.00	WIDSS1.0-1620	\$2,374.00	1"
16" x 36"	32.00	1	WID1.0-1636	\$2,266.00	WIDSS1.0-1636	\$3,536.00	1"
18" x 18"	20.00	1	WID1.0-1818	\$1,269.00	WIDSS1.0-1818	\$2,374.00	1"
20" x 30"	31.00	2	WID1.0-2030	\$2,266.00	WIDSS1.0-2030	\$3,536.00	1"
22" x 30"	32.00	2	WID1.0-2230	\$2,266.00	WIDSS1.0-2230	\$3,536.00	1"
22" x 36"	36.00	2	WID1.0-2236	\$2,398.00	WIDSS1.0-2236	\$3,751.00	1"
24" x 24"	28.00	1	WID1.0-2424	\$1,790.00	WIDSS1.0-2424	\$2,796.00	1"
24" x 36"	40.00	2	WID1.0-2436	\$2,685.00	WIDSS1.0-2436	\$3,678.00	1"
30" x 30"	38.00	2	WID1.0-3030	\$2,612.00	WIDSS1.0-3030	\$3,662.00	1"
30" x 60"	85.00	2	WID1.0-3060	\$3,998.00	WIDSS1.0-3060	\$5,000.00	1"
36" x 36"	50.00	2	WID1.0-3636	\$3,416.00	WIDSS1.0-3636	\$4,231.00	1"
36" x 48"	81.00	2	WID1.0-3648	\$3,976.00	WIDSS1.0-3648	\$4,558.00	1"

**WID Series with 1 1/2" Insulation Thickness**

"B" x "A"	SHIPPING WEIGHT (Lbs.)	LATCHES	GALVANIZED MODEL #	GALVANIZED LIST PRICE	STAINLESS STEEL MODEL #	LIST PRICE STAINLESS STEEL	INSULATION THICKNESS
12" x 12"	17.00	1	WID1.5-1212	\$1,171.00	WIDSS1.5-1212	\$2,198.00	1.5"
12" x 24"	25.00	2	WID1.5-1224	\$1,519.00	WIDSS1.5-1224	\$2,855.00	1.5"
14" x 14"	19.00	1	WID1.5-1414	\$1,269.00	WIDSS1.5-1414	\$2,380.00	1.5"
16" x 16"	20.00	1	WID1.5-1616	\$1,397.00	WIDSS1.5-1616	\$2,615.00	1.5"
16" x 20"	22.00	1	WID1.5-1620	\$1,519.00	WIDSS1.5-1620	\$2,855.00	1.5"
16" x 36"	35.00	1	WID1.5-1636	\$2,720.00	WIDSS1.5-1636	\$4,247.00	1.5"
18" x 18"	22.00	1	WID1.5-1818	\$1,519.00	WIDSS1.5-1818	\$2,855.00	1.5"
20" x 30"	34.00	2	WID1.5-2030	\$2,720.00	WIDSS1.5-2030	\$4,247.00	1.5"
22" x 30"	34.00	2	WID1.5-2230	\$2,720.00	WIDSS1.5-2230	\$4,247.00	1.5"
22" x 36"	40.00	2	WID1.5-2236	\$2,880.00	WIDSS1.5-2236	\$4,499.00	1.5"
24" x 24"	31.00	1	WID1.5-2424	\$2,147.00	WIDSS1.5-2424	\$3,354.00	1.5"
24" x 36"	44.00	2	WID1.5-2436	\$3,223.00	WIDSS1.5-2436	\$4,412.00	1.5"
30" x 30"	42.00	2	WID1.5-3030	\$3,134.00	WIDSS1.5-3030	\$4,394.00	1.5"
30" x 60"	90.00	2	WID1.5-3060	\$4,799.00	WIDSS1.5-3060	\$5,998.00	1.5"
36" x 36"	55.00	2	WID1.5-3636	\$4,100.00	WIDSS1.5-3636	\$5,078.00	1.5"
36" x 48"	90.00	2	WID1.5-3648	\$4,770.00	WIDSS1.5-3648	\$5,470.00	1.5"

**SERIES WID EXTERIOR ACCESS DOOR/WALK-IN DOOR**
**DESCRIPTION**

The MIFAB® WID exterior access doors are designed to provide convenient access to any exterior application, or anywhere that requires protection against air leakage and/or water penetration. WID doors are also designed to serve the custom air handling equipment manufacturers, as well as mechanical contractors who field assemble built-up air handling systems. All WID doors are manufactured using 10ga Galvanized Steel frames and 14ga Galvanized Steel door panels. WID doors are galvanized coated steel or optional stainless steel and aluminum. Door panels are insulated and gasketed. WID door can be manufactured in custom sizes from 12"x12" to 96"x96". Consult the factory for larger applications.

**SPECIFICATIONS**

**Flanged Frame:** 10ga. Galvanized Steel

**Door Panel:** 14ga. Galvanized Steel

**Insulation:** PCF fiberglass

**Handles:** Dual acting handles for inside and outside operation

**Gasket:** Extruded EPDM

**Hinge:** Zinc Plated Steel (Continuous)

**Finish:** Galvanized Coating

**Door Thickness:** 1", 1½", 2"

**Size Range:** 12"x12" thru 96"x96"

**WID Series with 2" Insulation Thickness**

"B" x "A"	SHIPPING WEIGHT (Lbs.)	LATCHES	GALVANIZED MODEL #	GALVANIZED LIST PRICE	STAINLESS STEEL MODEL #	LIST PRICE STAINLESS STEEL	INSULATION THICKNESS
12" x 12"	19.00	1	WID2.0-1212	\$1,409.00	WIDSS2.0-1212	\$2,638.00	2"
12" x 24"	27.00	2	WID2.0-1224	\$1,824.00	WIDSS2.0-1224	\$3,422.00	2"
14" x 14"	21.00	1	WID2.0-1414	\$1,519.00	WIDSS2.0-1414	\$2,856.00	2"
16" x 16"	22.00	1	WID2.0-1616	\$1,672.00	WIDSS2.0-1616	\$3,137.00	2"
16" x 20"	24.00	1	WID2.0-1620	\$1,824.00	WIDSS2.0-1620	\$3,423.00	2"
16" x 36"	38.00	1	WID2.0-1636	\$3,265.00	WIDSS2.0-1636	\$5,100.00	2"
18" x 18"	24.00	1	WID2.0-1818	\$1,824.00	WIDSS2.0-1818	\$3,423.00	2"
20" x 30"	37.00	2	WID2.0-2030	\$3,265.00	WIDSS2.0-2030	\$3,698.00	2"
22" x 30"	37.00	2	WID2.0-2230	\$3,265.00	WIDSS2.0-2230	\$5,100.00	2"
22" x 36"	44.00	2	WID2.0-2236	\$3,455.00	WIDSS2.0-2236	\$5,398.00	2"
24" x 24"	34.00	1	WID2.0-2424	\$2,576.00	WIDSS2.0-2424	\$4,025.00	2"
24" x 36"	48.00	2	WID2.0-2436	\$3,867.00	WIDSS2.0-2436	\$4,723.00	2"
30" x 30"	45.00	2	WID2.0-3030	\$3,763.00	WIDSS2.0-3030	\$5,275.00	2"
30" x 60"	100.00	2	WID2.0-3060	\$5,757.00	WIDSS2.0-3060	\$7,197.00	2"
36" x 36"	60.00	2	WID2.0-3636	\$4,917.00	WIDSS2.0-3636	\$6,090.00	2"
36" x 48"	100.00	2	WID2.0-3648	\$5,726.00	WIDSS2.0-3648	\$6,563.00	2"

CALIFORNIA PROPOSITION 65 WARNING. This product contains chemicals known to the State of California to cause cancer and birth defects or other reproductive harm.

Design and dimensions are subject to modification. Prices do not include applicable taxes.

Visit [www.mifab.com](http://www.mifab.com) for the most recent product information.

MIFAB®, Inc., 1321 West 119th Street, Chicago, Illinois 60643-5109, USA

Toll Free: 1-800-465-2736, Fax: 1-773-341-3049

All sales subject to MIFAB's® Terms and Warranties. Please refer to page no. 3.

sales@mifab.com Canada Toll Free: 1-800-387-3880



**MIFAB CATALOGS**



**MPB-2025-04-USA**  
SPECIFICATION DRAINAGE PRODUCTS  
(LIT-067)



**CLPB-2025-04**  
LIGHT COMMERCIAL DRAINAGE PRODUCTS  
(LIT-048)



**AD-2025-05-USA**  
ACCESS DOORS  
(LIT-043)



**BEECO-2025**  
BACKFLOW PREVENTERS, PRESSURE REDUCING VALVES, AUTOMATIC CONTROL VALVES, AND ACCESSORIES  
(LIT-071)



**NH-2025**  
NO HUB FLEXIBLE AND TRANSITION COUPLINGS AND ACCESSORIES  
(LIT-044)



**TPDC-2025-04**  
POLYMER CONCRETE TRENCH DRAINS  
(LIT-076)



**TD-2025-04**  
GRP AND STEEL TRENCH DRAINS  
(LIT-046)



**TDS-2025-04**  
SHOWER DRAINS  
(LIT-077)



**TDSS-2025-04**  
STAINLESS STEEL TRENCH DRAINS  
(LIT-072)



**2020**  
ROOFGUARD CATALOG  
"UNLOGGABLE" ROOF DRAIN DOMES  
(LIT-058)



**2023**  
C-PORT RUBBER PIPE SUPPORTS CATALOG  
(LIT-047)



**DB-2025-05**  
DIALYSIS BOXES  
(LIT-070)

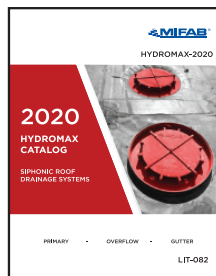

**2020**  
HYDROMAX CATALOG  
SIPHONIC ROOF DRAINAGE SYSTEMS  
(LIT-082)



**2025**  
INTERCEPTORS & ACID NEUTRALIZATION TANKS  
(LIT-095)



**2025**  
TRAP SEAL PRIMERS CATALOG  
(LIT-062)



CALIFORNIA PROPOSITION 65 WARNING. This product contains chemicals known to the State of California to cause cancer and birth defects or other reproductive harm.

Design and dimensions are subject to modification. Prices do not include applicable taxes.

Visit [www.mifab.com](http://www.mifab.com) for the most recent product information.

MIFAB®, Inc., 1321 West 119th Street, Chicago, Illinois 60643-5109, USA  
All sales subject to MIFAB's® Terms and Warranties. Please refer to page no. 3.

Toll Free: 1-800-465-2736, Fax: 1-773-341-3049  
sales@mifab.com Canada Toll Free: 1-800-387-3880



**AD-2025-05-USA**

**ACCESS  
DOORS  
CATALOG  
2025**  
(May 15, 2025)

**ACCESS DOORS**



**UNIVERSAL**

-

**DRYWALL BEAD**

-

**FIRE RATED**

**LIT-043**