



"I just wanted to let you know that we love the MI-XHUB heavy duty no hub coupling for the no-hub cast iron installation. They seem to go together with more ease than other couplings. The field has mentioned to me many times to get my hands on the MI-XHUB instead of other brands. The availability has always been there for us."

- Richard Barnes, Project Manager/Estimator at Walton Plumbing, Houston, TX

NH-2019

Go to
www.mifab.com
for the most
current product
specification
sheets.



Couplings LIT-044

TABLE OF CONTENTS

DISCOUNT	DISCOUNT
MI-HUB and MI-XHUB Cross Reference.....4	C1440-NH..... 13
MI-HUB and MI-XHUB List Prices4	MI-ELB..... 14
MI-HUB-ARC.....5	MI-TEE..... 14
MI-HUB-ARC-CL.....5	MI-HUB Specification Sheet.....16
MI-FLEX.....6	MI-HUB Features and Benefits..... 17
MI-FLEX-CC.....7	MI-HUB Installation Instructions..... 18
MI-FLEX-CL.....7	MI-HUB - IAPMO Certificate of Listing.....19
MI-FLEX-EXP.....8	MI-HUB - CSA Certificate of Compliance.....20
MI-HUB-TRS.....8	MI-HUB - CSA Certificate of Compliance.....21
MI-HUB-TR.....9	MI-XHUB Specification Sheet.....22
MI-HUB-TRC.....9	MI-XHUB Features and Benefits.....23
MI-HUB-TRP.....10	MI-XHUB Installation Instructions.....24
MI-HUB-TRT.....10	MI-XHUB - IAPMO Certificate of Listing.....25
MI-HUB-TRCC.....11	MI-XHUB - FM1680-1989 Test Report.....26
MI-HUB-TRTW.....11	MI-HUB vs. MI-XHUB applications.....27
MI-FLEX-DTC.....12	Required Use of Hangers and Supports.....27
MI-FLEX-DISH.....12	MI-TORQUE.....28
MI-EC.....13	MI-HUB and MI-XHUB Project References.....29
MI-EC-HB.....15	

“Winsupply of San Diego has been ordering MIFAB MI-HUB no hub couplings for at least the past two years. We find the ordering process simple and smooth and the receiving process seamless and accurate. They have been a pleasure to work with.” – David Meinung, Purchasing Manager, WINSUPPLY, San Diego, CA

TERMS AND CONDITIONS

WHOLESALE DISCOUNT: Contact MIFAB® or your local representative for your applicable discount structure.

FREIGHT ALLOWANCE: Ex Works, MIFAB’s Chicago, Illinois Factory or Manufacturer Representative’s warehouse with full motor freight allowed on shipments of \$3,500.00 Net or more, within the continental U.S.A. or Canada, except Alaska, Hawaii and Puerto Rico. MIFAB® reserves the right to choose the carrier and route of shipment. Alaska: Ex Works, Seattle, WA. Hawaii: Freight allowed on shipments of \$3,500.00 or more only when shipped from West Coast, U.S. Puerto Rico: Ex Works, Miami, Florida. There is no allowance for United Parcel Service, Federal Express or Shipment by air service. Full motor freight is allowed on shipments of \$3,500.00 Net or more, within the continental U.S.A. and Canada for any combination of BEECO, Counterline, No Hub Coupling, Trench Drain, Access Door and Trap Seal Primer products. Shipping dates are estimates and time of delivery is not the essence of the sale of the contract. Therefore, under no circumstances will MIFAB have any responsibility on account of any delays in manufacture, transportation, or otherwise. Additional freight services such as construction site delivery, lift gate delivery service, re-consigned freight or notification charges, are not included in full freight allowance terms, and will result in additional freight charges.

QUOTATION TERMS: List Price and discount protected for 30 days from date issued by MIFAB®. Orders received within this period must be released for shipment within 30 days from date of purchase order, otherwise, prices will be those that are in effect at the time of shipment.

PAYMENT TERMS: Terms of payment are Net 30 days from the date of the invoice. All pricing in United States currency unless sold in Canada in which case Canadian dollars is the currency used. The Buyer shall pay all sales, consumers, and / or any other applicable taxes. Past due accounts will be subject to a 2% per month service charge from the date of the invoice. If any proceedings be instructed by or against Buyer under any bankruptcy or insolvency law, or if Buyer shall fail to make timely payment on this or any other order, or if, in MIFAB’s judgment, Buyer’s financial situation justifies such action, MIFAB® may, at its election, require payment in advance or cancel the order as to any unshipped item and require payment of its reasonable cancellation charges. If Buyer delays completion of manufacture, MIFAB® may elect to require payment according to percentage of completion. Equipment held for Buyer shall be at Buyer’s risk and expense. In all cases, regardless of partial payment, title to the Products shall remain with MIFAB® until payment for the Products (including any notes given therefore) has been made in full. Should legal action be necessary to enforce payment of an unpaid invoice, the Buyer will assume full responsibility for any court costs and reasonable attorney fees. All orders subject to credit check and approval prior to shipment. Confirmed irrevocable letter of credit or cash in advance of shipment is required for accounts without an established line of credit. Minimum invoice amount is \$100.00. MIFAB reserves the right to apply a minimum order charge to equal \$100.00. MIFAB’s Accounting Department must be notified of potential pricing errors within 30 days of the invoice date. Any terms and conditions stated on Buyer’s orders which are inconsistent with MIFAB’s quotation and Terms and Warranties shall be of no effect.

RETURNED GOODS RESTOCKING CHARGE: Standard product may be returned within a one year period only with written permission from MIFAB®. All products in catalog are not considered Standard. Standard product to be determined by MIFAB®. Returned goods are subject to a 25% restocking charge, plus cost of reconditioning, if necessary, to make material saleable. Material must be returned to MIFAB® freight prepaid only after written permission from MIFAB® to accept the returned material. Buyer must provide copy of the original invoice on which the material was charged. The original outgoing freight cost to ship the order will be deducted from the credit. Credit allowance will be in the form of merchandise credit only-not cash credit which must be used within 12 months of the date of issue. The value of a return must total \$100.00 to qualify for credit allowance. Galvanized and acid resistant epoxy coated material will be credited to value of cast iron, and chrome plated at value of nickel bronze. No credit will be allowed for auxiliary tappings, discontinued, or made to order items. Products designated non stock and / or that have been specially made (require a sign off drawing by MIFAB®) are not subject to return or cancellation.

LIMITED WARRANTY: MIFAB® warrants each product against defects in material and workmanship for a period of one year from the date of original shipment. In the event of such defects within the warranty period, MIFAB® will, at its option, replace or recondition the product without charge. This shall constitute the exclusive remedy for breach of warranty, and MIFAB® shall not be responsible for any incidental or consequential damages, including, without limitation, damages or other costs resulting from labor charges, delays, vandalism, negligence, fouling caused by foreign material, damage from adverse water conditions, chemicals, or any other circumstances over which MIFAB® has no control. This warranty shall be invalidated by any abuse, misuse, misapplication or improper installation of the product.

MIFAB MAKES NO OTHER WARRANTIES EXPRESSED OR IMPLIED AS PROVIDED IN THIS LIMITED WARRANTY.

ILLUSTRATIONS OR TYPICAL INSTALLATIONS: The typical installations for various products in each product section are intended to illustrate the products and their options. Under no circumstances are they to be construed as recommended installation procedures. Consult local codes and project specifications for proper installation instructions.

ALL SALES SUBJECT TO MIFAB’S TERMS AND WARRANTIES.

NOTE: Prices and terms are subject to change without notice and supersede all previous quotations. The right is reserved to change or modify product design or construction without prior notice and without incurring any obligation to make similar changes and modifications to product previously or subsequently sold. Contact MIFAB® for any clarification.

CONTENTS © MIFAB® INC. Copyright 2017

CALIFORNIA PROPOSITION 65 WARNING. This product contains chemicals known to the State of California to cause cancer and birth defects or other reproductive harm.

A Design and dimensions are subject to modification. Prices do not include applicable taxes. Visit www.mifab.com for the most recent product information.

MIFAB®, Inc., 1321 West 119th Street, Chicago, Illinois 60643-5109, USA

Toll Free: 1-800-465-2736, Fax: 1-773-341-3049

All sales subject to MIFAB’s® Terms and Warranties. Please refer to inside front cover.

sales@mifab.com • Canada Toll Free: 1-800-387-3880

PICTORIAL INDEX

MIFAB's various coupling products are organized into five different categories. Please contact your local MIFAB representative for the discount structure for each category.

REGULAR DUTY SHIELDED NO HUB COUPLINGS - MI-HUB SERIES	HEAVY DUTY SHIELDED NO HUB COUPLINGS - MI-XHUB SERIES
 MI-HUB (Page 4)	 MI-XHUB (Page 4)
Discount Structure	Discount Structure

FLEXIBLE COUPLINGS - MI-FLEX, MI-FLEX-CC, MI-FLEX-CL, MI-FLEX-DTC, MI-FLEX-DISH, MI-EC, C1440-NH, MI-ELB, MI-TEE & R1900-NH SERIES

 MI-FLEX (Page 6)	 MI-FLEX-CL (Page 7)	 MI-FLEX-CC (Page 7)	 MI-FLEX-EXP (Page 8)	 MI-FLEX-DTC (Page 12)	Discount Structure
 MI-FLEX-DISH (Page 12)	 MI-EC (Page 13)	 MI-EC-HB (Page 15)	 C1440-NH (Page 13)	 MI-ELB (Page 14)	

TRANSITION COUPLINGS -

MI-HUB-TR, MI-HUB-TRC, MI-HUB-TRT, MI-HUB-TRS, MI-HUB-TRP, MI-HUB-TRCC, MI-HUB-TRTW, MI-HUB-ARC, MI-HUB-ARC-CL, MI-TORQUE

 MI-HUB-ARC (Page 5)	 MI-HUB-ARC-CL (Page 5)	 MI-HUB-TRS (Page 8)	 MI-HUB-TR (Page 9)	 MI-HUB-TRC (Page 9)	Discount Structure
 MI-HUB-TRT (Page 10)	 MI-HUB-TRP (Page 10)	 MI-HUB-TRCC (Page 11)	 MI-HUB-TRTW (Page 11)	 MI-TORQUE (Page 15)	

PIPE MATERIAL

OUTSIDE PIPE DIAMETERS

	3/4"	1"	1 1/4"	1 1/2"	2"	3"	4"	5"	6"	8"	10"	12"
ABS / PVC Plastic	1.05" (27)	1.315" (33)	1.66" (42)	1.90" (48)	2.375" (60)	3.50" (89)	4.50" (114)	5.56" (141)	6.62" (168)	8.62" (219)	10.75" (273)	12.75" (324)
(Schedule 40)												
Asbestos Cement	-	-	-	-	-	-	4.81" (122)	5.90" (150)	6.92" (176)	9.02" (229)	11.12" (282)	13.22" (336)
(Class 1500 - Transite)												
Cast Iron	-	-	-	1.90" (48)	2.35" (60)	3.35" (85)	4.38" (111)	5.30" (135)	6.30" (160)	8.38" (213)	10.56" (268)	12.50" (318)
Clay	-	-	-	-	-	-	5.37" (136)	6.65" (169)	7.68" (195)	9.90" (251)	12.43" (316)	14.46" (367)
Concrete	-	-	-	-	-	-	6.00" (152)	6.50" (165)	8.00" (203)	10.25" (260)	12.75" (324)	15.10" (384)
Copper	.875" (22)	1.125" (29)	1.375" (35)	1.625" (41)	2.125" (54)	3.125" (79)	4.125" (105)	5.125" (130)	6.125" (156)	8.125" (206)	10.125" (257)	-
Ductile Iron	-	-	-	-	-	-	4.80" (122)	-	6.90" (175)	9.05" (230)	11.10" (282)	13.20" (335)
Duriron (add encircled R)	-	-	-	2.19" (56)	2.63" (67)	3.75" (95)	4.75" (121)	-	6.69" (170)	-	-	-
Extra Heavy Cast Iron	-	-	-	-	2.38" (60)	3.50" (89)	4.50" (114)	5.50" (140)	6.62" (168)	8.62" (219)	10.75" (273)	12.75" (324)
Stainless Steel	.75" (19)	1.00" (25)	1.25" (32)	1.50" (38)	2.00" (51)	3" (76)	4" (102)	5" (127)	6" (152)	8" (203)	10" (254)	-
Steel	1.05" (27)	1.315" (33)	1.66" (42)	1.90" (48)	2.375" (60)	3.50" (89)	4.50" (114)	5.56" (141)	6.62" (168)	8.62" (219)	10.75" (273)	12.75" (324)
Thinwall Plastic PVC (SDR 35)	-	-	-	-	-	-	-	-	-	-	-	12.50" (318)
-	-	-	-	-	3.25" (83)	4.215" (107)	-	6.27" (159)	8.40" (213)	10.50" (267)	-	-

CALIFORNIA PROPOSITION 65 WARNING. This product contains chemicals known to the State of California to cause cancer and birth defects or other reproductive harm.

Design and dimensions are subject to modification. Prices do not include applicable taxes. Visit www.mifab.com for the most recent product information.

MIFAB®, Inc., 1321 West 119th Street, Chicago, Illinois 60643-5109, USA

All sales subject to MIFAB'S® Terms and Warranties. Please refer to inside front cover.

Toll Free: 1-800-465-2736, Fax: 1-773-341-3049

sales@mifab.com • Canada Toll Free: 1-800-387-3880

MIFAB's shielded transition couplings join similar and dissimilar pipe sizes and pipe materials

Features:

- Rubber sleeve conforms to ASTM Standard C564
- Stainless steel meets ASTM Standard A240M
- All transition couplings use 5/16" hex head screws and tighten to 60 inch / lbs. torque.
- Corrossion resistant Type 300 Series stainless steel
- Couplings meet and exceed the material and performance requirements of ASTM Standard C1460

Material Guide

- CI = Cast Iron
- K = Copper
- LD = Lead
- PL = Plastic (Sch. 40)
- XH CI = Extra Heavy Cast Iron
- ST = Steel

"We use the MI-HUB and MI-XHUB no hub couplings from MIFAB. No problems, great service and the best price point in the industry. MIFAB no hub couplings are a win-win for us."

– Joe Rooks, Manager, L.A. Plumbing Supply, Duarte, CA

COUPLINGS THAT JOIN CAST IRON PIPE

1 1/2" Cast Iron to...

Join	Use Coupling
1" Plastic	MI-HUB-TRC-1125
1" Steel	MI-HUB-TRC-1125
1 1/4" Copper	MI-HUB-TRC-1125
1 1/4" Plastic	MI-HUB-TRC-150
1 1/4" Steel	MI-HUB-TRC-150
1 1/2" Copper	MI-HUB-TRC-150
1 1/2" Plastic	MI-HUB-TR-150
1 1/2" Steel	MI-HUB-TR-150
1 1/2" Tubular	MI-HUB-TRT-150
2" Plastic	MI-HUB-TR-215
2" Steel	MI-HUB-TR-215

2" Cast Iron to...

Join	Use Coupling
1" Plastic	MI-HUB-TRC-2125

1" Steel	MI-HUB-TRC-2125
1 1/4" Copper	MI-HUB-TRC-2125
1 1/4" Plastic	MI-HUB-TRC-215
1 1/4" Steel	MI-HUB-TRC-215
1 1/2" Copper	MI-HUB-TRC-215
1 1/2" Plastic	MI-HUB-TR-215
1 1/2" Steel	MI-HUB-TR-215
1 1/2" Tubular	MI-HUB-TRT-215
2" Copper	MI-HUB-TRC-220
2" Plastic	MI-HUB-TR-200
2" Steel	MI-HUB-TR-200
3" Cast Iron	MI-HUB-32
4" Cast Iron	MI-HUB-42

3" Cast Iron to...

Join	Use Coupling
2" Copper	MI-HUB-TRC-320
2" Cast Iron	MI-HUB-32
2" Plastic	MI-HUB-32
2" Steel	MI-HUB-32

3" Copper	MI-HUB-TRC-330
3" Plastic	MI-HUB-TR-330
3" Steel	MI-HUB-TR-330
3" Extra Heavy Cast Iron	MI-HUB-TR-330
4" Cast Iron	MI-HUB-43

4" Cast Iron to...

Join	Use Coupling
2" Cast Iron	MI-HUB-42
2" Plastic	MI-HUB-42
2" Steel	MI-HUB-42
3" Copper	MI-HUB-TRC-430
3" Cast Iron	MI-HUB-43
3" Plastic	MI-HUB-TR-430
3" Steel	MI-HUB-TR-430
3" Extra Heavy Cast Iron	MI-HUB-TR-430
4" Copper	MI-HUB-TRC-440
4" Plastic	MI-HUB-TR-440
4" Steel	MI-HUB-TR-440
4" Extra Heavy Cast Iron	MI-HUB-TR-440

COUPLINGS THAT JOIN COPPER PIPE

1 1/4" Copper to...

Join	Use Coupling
1 1/4" Plastic	MI-HUB-TRCC-1125
1 1/2" Copper	MI-HUB-TRCC-1125
1 1/2" Cast Iron	MI-HUB-TRC-1125
1 1/2" Plastic	MI-HUB-TRC-1125
1 1/2" Steel	MI-HUB-TRC-1125
2" Cast Iron	MI-HUB-TRC-2125
2" Plastic	MI-HUB-TRC-2125
2" Steel	MI-HUB-TRC-2125

1 1/2" Copper to...

Join	Use Coupling
1" Plastic	MI-HUB-TRCC-1125
1" Steel	MI-HUB-TRCC-1125

1 1/4" Copper	MI-HUB-TRCC-1125
1 1/4" Plastic	MI-HUB-TRCC-150
1 1/4" Steel	MI-HUB-TRCC-150
1 1/2" Copper	MI-HUB-TRCC-150
1 1/2" Cast Iron	MI-HUB-TRC-150
1 1/2" Plastic	MI-HUB-TRC-150
1 1/2" Steel	MI-HUB-TRC-150
2" Copper	MI-HUB-TRCC-215
2" Cast Iron	MI-HUB-TRC-215
2" Plastic	MI-HUB-TRC-215
2" Steel	MI-HUB-TRC-215

2" Copper to...

Join	Use Coupling
1 1/4" Plastic	MI-HUB-TRCC-215
1 1/2" Copper	MI-HUB-TRCC-215
2" Copper	MI-HUB-TRCC-200
2" Cast Iron	MI-HUB-TRC-220
2" Plastic	MI-HUB-TRC-220

2" Steel	MI-HUB-TRC-220
3" Cast Iron	MI-HUB-TRC-320

3" Copper to...

Join	Use Coupling
3" Copper	MI-HUB-TRC-330
3" Cast Iron	MI-HUB-TRC-330
3" Plastic	MI-HUB-TRS-330
3" Steel	MI-HUB-TRS-330
3" Extra Heavy Cast Iron	MI-HUB-TRS-330
4" Cast Iron	MI-HUB-TRC-430

4" Copper to...

Join	Use Coupling
4" Cast Iron	MI-HUB-TRC-440
4" Plastic	MI-HUB-TRS-440
4" Steel	MI-HUB-TRS-440
4" Extra Heavy Cast Iron	MI-HUB-TRS-440

COUPLINGS THAT JOIN EXTRA HEAVY CAST IRON PIPE

3" Extra Heavy Cast Iron to...

Join	Use Coupling
3" Copper	MI-HUB-TRS-330
3" Cast Iron	MI-HUB-TR-330
3" Plastic	MI-HUB-TRP-330
3" Steel	MI-HUB-TRP-330
3" Extra Heavy Cast Iron	MI-HUB-TRP-330
4" Cast Iron	MI-HUB-TR-430
4" Plastic	MI-HUB-TRP-430
4" Steel	MI-HUB-TRP-430
4" Extra Heavy Cast Iron	MI-HUB-TRP-430

4" Extra Heavy Cast Iron to...

Join	Use Coupling
3" Plastic	MI-HUB-TRP-430
3" Steel	MI-HUB-TRP-430
3" Extra Heavy Cast Iron	MI-HUB-TRP-430
4" Copper	MI-HUB-TRS-440
4" Cast Iron	MI-HUB-TR-440
4" Plastic	MI-HUB-TRP-440
4" Steel	MI-HUB-TRP-440
4" Extra Heavy Cast Iron	MI-HUB-TRP-440
4" Thinwall Plastic	MI-HUB-TRTW-440

5" Extra Heavy Cast Iron to...

Join	Use Coupling
5" Cast Iron	MI-HUB-TR-550

6" Extra Heavy Cast Iron to...

Join	Use Coupling
6" Cast Iron	MI-HUB-TR-660
6" Plastic	MI-HUB-TRP-660
6" Steel	MI-HUB-TRP-660
6" Extra Heavy Cast Iron	MI-HUB-TRP-660
8" Cast Iron	MI-HUB-TR-880

8" Extra Heavy Cast Iron to...

Join	Use Coupling
8" Cast Iron	MI-HUB-TR-880

CALIFORNIA PROPOSITION 65 WARNING. This product contains chemicals known to the State of California to cause cancer and birth defects or other reproductive harm.

COUPLINGS THAT JOIN SCHEDULE 40 PLASTIC PIPE (ABS + PVC)
1" Plastic to...

1 1/4"	Plastic.....	MI-HUB-TRCC-1125
1 1/4"	Steel.....	MI-HUB-TRCC-1125
1 1/2"	Copper.....	MI-HUB-TRCC-1125
1 1/2"	Cast Iron.....	MI-HUB-TRC-1125
1 1/2"	Plastic.....	MI-HUB-TRC-1125
1 1/2"	Steel.....	MI-HUB-TRC-1125
2"	Plastic.....	MI-HUB-TRC-2125
2"	Steel.....	MI-HUB-TRC-2125
2"	Cast Iron.....	MI-HUB-TRC-2125

1 1/4" Plastic to...

1"	Plastic.....	MI-HUB-TRCC-1125
1"	Steel.....	MI-HUB-TRCC-1125
1"	Copper (IPS).....	MI-HUB-TRCC-1125
1 1/4"	Copper.....	MI-HUB-TRCC-1125
1 1/4"	Plastic.....	MI-HUB-TRCC-150
1 1/4"	Steel.....	MI-HUB-TRCC-150
1 1/2"	Copper.....	MI-HUB-TRCC-150
1 1/2"	Cast Iron.....	MI-HUB-TRC-150
1 1/2"	Plastic.....	MI-HUB-TRC-150
1 1/2"	Steel.....	MI-HUB-TRC-150

1 1/2" Plastic to...

1"	Plastic.....	MI-HUB-TRC-1125
1"	Steel.....	MI-HUB-TRC-1125
1 1/4"	Copper.....	MI-HUB-TRC-1125
1 1/4"	Plastic.....	MI-HUB-TRC-150
1 1/4"	Steel.....	MI-HUB-TRC-150
1 1/2"	Copper.....	MI-HUB-TRC-150
1 1/2"	Cast Iron.....	MI-HUB-TR-150
1 1/2"	Plastic.....	MI-HUB-TR-150
1 1/2"	Steel.....	MI-HUB-TR-150
1 1/2"	Tubular.....	MI-HUB-TRT-150
2"	Cast Iron.....	MI-HUB-TR-215
2"	Plastic.....	MI-HUB-TR-215
2"	Steel.....	MI-HUB-TR-215

COUPLINGS THAT JOIN STEEL PIPE
1" Steel to...

1 1/4"	Plastic.....	MI-HUB-TRCC-1125
1 1/4"	Steel.....	MI-HUB-TRCC-1125
1 1/2"	Copper.....	MI-HUB-TRCC-1125
1 1/2"	Cast Iron.....	MI-HUB-TRC-1125
1 1/2"	Plastic.....	MI-HUB-TRC-1125
1 1/2"	Steel.....	MI-HUB-TRC-1125
2"	Cast Iron.....	MI-HUB-TRC-2125
2"	Plastic.....	MI-HUB-TRC-2125
2"	Steel.....	MI-HUB-TRC-2125

1 1/4" Steel to...

1"	Plastic.....	MI-HUB-TRCC-1125
1"	Steel.....	MI-HUB-TRCC-1125
1"	Copper (IPS).....	MI-HUB-TRCC-1125
1 1/4"	Copper.....	MI-HUB-TRCC-1125
1 1/4"	Plastic.....	MI-HUB-TRCC-150
1 1/4"	Steel.....	MI-HUB-TRCC-150
1 1/2"	Copper.....	MI-HUB-TRCC-150
1 1/2"	Cast Iron.....	MI-HUB-TRC-150
1 1/2"	Plastic.....	MI-HUB-TRC-150
1 1/2"	Steel.....	MI-HUB-TRC-150
2"	Copper.....	MI-HUB-TRCC-215
2"	Cast Iron.....	MI-HUB-TRC-215
2"	Plastic.....	MI-HUB-TRC-215
2"	Steel.....	MI-HUB-TRC-215

1 1/2" Steel to...

1"	Plastic.....	MI-HUB-TRC-1125
----	--------------	-----------------

2" Plastic to...

1"	Plastic.....	MI-HUB-TRC-2125
1"	Steel.....	MI-HUB-TRC-2125
1"	Copper (IPS).....	MI-HUB-TRC-2125
1 1/4"	Copper.....	MI-HUB-TRC-2125
1 1/4"	Plastic.....	MI-HUB-TRC-215
1 1/4"	Steel.....	MI-HUB-TRC-215
1 1/2"	Copper.....	MI-HUB-TRC-215
1 1/2"	Cast Iron.....	MI-HUB-TR-215
1 1/2"	Plastic.....	MI-HUB-TR-215
1 1/2"	Steel.....	MI-HUB-TR-215
1 1/2"	Tubular.....	MI-HUB-TRT-215
2"	Copper.....	MI-HUB-TRC-220
2"	Cast Iron.....	MI-HUB-TR-200
2"	Plastic.....	MI-HUB-TR-200
2"	Steel.....	MI-HUB-TR-200
3"	Cast Iron.....	MI-HUB-32
4"	Cast Iron.....	MI-HUB-42

3" Plastic to

3"	Copper.....	MI-HUB-TRS-330
3"	Cast Iron.....	MI-HUB-TR-330
3"	Plastic.....	MI-HUB-TRP-330
3"	Steel.....	MI-HUB-TRP-330
3"	Extra Heavy Cast Iron.....	MI-HUB-TRP-330
4"	Cast Iron.....	MI-HUB-TR-430
4"	Plastic.....	MI-HUB-TRP-430
4"	Steel.....	MI-HUB-TRP-430
4"	Extra Heavy Cast Iron.....	MI-HUB-TRP-430

4" Plastic to...

3"	Plastic.....	MI-HUB-TRP-430
3"	Steel.....	MI-HUB-TRP-430
3"	Extra Heavy Cast Iron.....	MI-HUB-TRP-430
4"	Copper.....	MI-HUB-TRS-440
4"	Cast Iron.....	MI-HUB-TR-440
4"	Plastic.....	MI-HUB-TRP-440
4"	Steel.....	MI-HUB-TRP-440
4"	Extra Heavy Cast Iron.....	MI-HUB-TRP-440
4"	Thinwall Plastic.....	MI-HUB-TRTW-440

5" Plastic to...

5"	Cast Iron.....	MI-HUB-TR-550
----	----------------	---------------

6" Plastic to...

6"	Cast Iron.....	MI-HUB-TR-660
6"	Plastic.....	MI-HUB-TRP-660
6"	Steel.....	MI-HUB-TRP-660
6"	Extra Heavy Cast Iron.....	MI-HUB-TRP-660

8" Plastic to...

8"	Cast Iron.....	MI-HUB-TR-880
----	----------------	---------------

COUPLINGS THAT JOIN THINWALL PLASTIC PIPE (sewer and drain)
4" Thinwall Plastic to...

Join.....	Use Coupling	
4"	Plastic (Sch. 40).....	MI-HUB-TRTW-440
4"	Steel.....	MI-HUB-TRTW-440
4"	Extra Heavy Cast Iron.....	MI-HUB-TRTW-440

COUPLINGS THAT JOIN TUBULAR PIPE
1 1/2" Tubular to...

Join.....	Use Coupling	
1 1/2"	Cast Iron.....	MI-HUB-TRT-150
1 1/2"	Plastic.....	MI-HUB-TRT-150
1 1/2"	Steel.....	MI-HUB-TRT-150
1 1/2"	Tubular.....	MI-HUB-TRT-155
2"	Cast Iron.....	MI-HUB-TRT-215
2"	Plastic.....	MI-HUB-TRT-215
2"	Steel.....	MI-HUB-TRT-215

1"	Steel.....	MI-HUB-TRC-1125
1 1/4"	Copper.....	MI-HUB-TRC-1125
1 1/4"	Plastic.....	MI-HUB-TRC-150
1 1/4"	Steel.....	MI-HUB-TRCC-150
1 1/2"	Copper.....	MI-HUB-TRC-150

1 1/2" Steel to...

1 1/2"	Cast Iron.....	MI-HUB-TR-150
1 1/2"	Plastic.....	MI-HUB-TR-150
1 1/2"	Steel.....	MI-HUB-TR-150
1 1/2"	Tubular.....	MI-HUB-TRCC-150
2"	Cast Iron.....	MI-HUB-TR-215
2"	Plastic.....	MI-HUB-TR-215
2"	Steel.....	MI-HUB-TR-215

2" Steel to...

1"	Plastic.....	MI-HUB-TRC-2125
1"	Steel.....	MI-HUB-TRC-2125
1"	Copper (IPS).....	MI-HUB-TRC-2125
1 1/4"	Copper.....	MI-HUB-TRC-2125
1 1/4"	Plastic.....	MI-HUB-TRC-215
1 1/4"	Steel.....	MI-HUB-TRC-215
1 1/2"	Copper.....	MI-HUB-TRC-215
1 1/2"	Cast Iron.....	MI-HUB-TR-215
1 1/2"	Plastic.....	MI-HUB-TR-215
1 1/2"	Steel.....	MI-HUB-TR-215
1 1/2"	Tubular.....	MI-HUB-TRT-215
2"	Copper.....	MI-HUB-TRC-220
2"	Cast Iron.....	MI-HUB-TR-200
2"	Plastic.....	MI-HUB-TR-200
2"	Steel.....	MI-HUB-TR-200
3"	Cast Iron.....	MI-HUB-32
4"	Cast Iron.....	MI-HUB-42

3" Steel to...

3"	Copper.....	MI-HUB-TRS-330
3"	Cast Iron.....	MI-HUB-TR-330
3"	Plastic.....	MI-HUB-TRP-330
3"	Steel.....	MI-HUB-TRP-330
3"	Extra Heavy Cast Iron.....	MI-HUB-TRP-330
4"	Cast Iron.....	MI-HUB-TR-430
4"	Plastic.....	MI-HUB-TRP-430
4"	Steel.....	MI-HUB-TRP-430
4"	Extra Heavy Cast Iron.....	MI-HUB-TRP-430

4" Steel to...

3"	Plastic.....	MI-HUB-TRP-430
3"	Steel.....	MI-HUB-TRP-430
3"	Extra Heavy Cast Iron.....	MI-HUB-TRP-430
4"	Copper.....	MI-HUB-TRS-440
4"	Cast Iron.....	MI-HUB-TR-440
4"	Plastic.....	MI-HUB-TRP-440
4"	Steel.....	MI-HUB-TRP-440
4"	Extra Heavy Cast Iron.....	MI-HUB-TRP-440
4"	Thinwall Plastic.....	MI-HUB-TRTW-440

5" Steel to...

5"	Cast Iron.....	MI-HUB-TR-550
----	----------------	---------------

6" Steel to...

6"	Cast Iron.....	MI-HUB-TR-660
6"	Plastic.....	MI-HUB-TRP-660
6"	Steel.....	MI-HUB-TRP-660
6"	Extra Heavy Cast Iron.....	MI-HUB-TRP-660

8" Steel to...

8"	Cast Iron.....	MI-HUB-TR-880
----	----------------	---------------

CALIFORNIA PROPOSITION 65 WARNING. This product contains chemicals known to the State of California to cause cancer and birth defects or other reproductive harm.

Design and dimensions are subject to modification. Prices do not include applicable taxes. Visit www.mifab.com for the most recent product information.

MIFAB®, Inc., 1321 West 119th Street, Chicago, Illinois 60643-5109, USA

Toll Free: 1-800-465-2736, Fax: 1-773-341-3049

All sales subject to MIFAB's® Terms and Warranties. Please refer to inside front cover.

sales@mifab.com • Canada Toll Free: 1-800-387-3880

MI-HUB REGULAR NO HUB COUPLINGS



Tested and certified to ASTM Standard #C1277-2018 and ASTM Standard #C564. All models are listed with IAPMO and NSF certified to CISPI 310. 5/16" driver required to tighten bolts. Gaskets are made from neoprene.

NOTE: Tighten bolts to 60 inch lbs. min./max torque. Tested to maintain 4.3 p.s.i. maximum line pressure. (10' head pressure.) Tested by I.A.P.M.O. to comply to the CISPI310-2010 and CSA B602-2016 File # 247608 Standards. Tested and certified by Intertek Testing Services to CAN/ULC S102.2-07, "Smoke Test." Stainless Steel Shield and Clamps are made from Type 301 S.S. Bolts are Type 305 Stainless Steel, 5/16" hex head. NSF Certified to the CISPI 310 Standard.



"The MIFAB MI-XHUB heavy duty no hub couplings are great and easy to order and they never have had a failure in the field."

– CD West, Aurora Winnelson, Aurora, CO

MODEL NUMBER	PIPE SIZE	C HEIGHT	CARTON QUANTITY	PALLET QUANTITY	LIST PRICE, Each Piece
MI-HUB-150	1-1/2"	2.125" (54)	100	7,200	\$19.35
MI-HUB-2	2"	2.125" (54)	100	6,300	\$19.35
MI-HUB-2150	2" x 1-1/2"	2.125" (54)	100	6,300	\$22.50
MI-HUB-3	3"	2.125" (54)	100	3,200	\$23.10
MI-HUB-32	3" x 2"	2.125" (54)	100	2,400	\$35.10
MI-HUB-4	4"	2.125" (54)	100	2,400	\$27.30
MI-HUB-42	4" x 2"	2.125" (54)	64	1,536	\$49.70
MI-HUB-43	4" x 3"	2.125" (54)	64	1,536	\$41.70
MI-HUB-5	5"	3" (76)	20	960	\$66.40
MI-HUB-6	6"	3" (76)	25	875	\$69.10
MI-HUB-8	8"	4" (102)	15	360	\$130.60
MI-HUB-10	10"	4" (102)	12	288	\$172.40
MI-HUB-12	12"	5.43" (138)	8	96	\$187.80
MI-HUB-15	15"	5.43" (138)	4	48	\$262.90

MI-XHUB HEAVY DUTY NO HUB COUPLINGS



Tested and certified to ASTM Standard #C1540-2015 and ASTM Standard #C564. All models are listed with IAPMO (U.P.C.). 3/8" driver required to tighten bolts. Gaskets are made from neoprene.

NOTE: Tighten bolts to 80 inch lbs. minimum torque to 100 inch lbs. maximum torque. Tested to maintain 15 p.s.i. maximum line pressure. (10' head pressure.) Tested by I.A.P.M.O. to comply to the FM1680-1989 (except for markings) and CSA B602-2016 Standards (up to 10"). Per OSHPD Code Application Notice 5-311.9 revised 6/29/2011, signed by Paul Coleman, Section 1 (a) states that: "the use of couplings that have been tested to conform to the performance requirements of FM Approvals, Approval Standard 1680, Class 1, by FM Approvals or by a nationally recognized independent testing agency," are acceptable. The MI-XHUB are also tested and certified by Intertek Testing Services to CAN / ULC S102.2-10 "Smoke Test" Stainless Steel Shield and Clamps are made from Type 304 S.S. Bolts are Type 305 Stainless Steel, 3/8" hex head.



MODEL NUMBER	PIPE SIZE	C HEIGHT	CARTON QUANTITY	PALLET QUANTITY	LIST PRICE, Each Piece
MI-XHUB-150	1-1/2"	3" (76)	60	2,280	\$18.90
MI-XHUB-2	2"	3" (76)	72	1,728	\$20.20
MI-XHUB-3	3"	3" (76)	24	960	\$23.30
MI-XHUB-32	3" x 2"	3" (76)	24	960	\$31.00
MI-XHUB-4	4"	3" (76)	24	576	\$27.10
MI-XHUB-42	4" x 2"	3" (76)	24	576	\$43.00
MI-XHUB-43	4" x 3"	3" (76)	24	576	\$36.80
MI-XHUB-5	5"	4" (102)	27	324	\$55.70
MI-XHUB-6	6"	4" (102)	27	324	\$66.00
MI-XHUB-8	8"	4" (102)	15	180	\$130.50
MI-XHUB-10	10"	4" (102)	9	108	\$167.90
MI-XHUB-12	12"	5.43" (138)	5	60	\$214.30
MI-XHUB-15	15"	5.43" (138)	4	32	\$273.80

CROSS REFERENCE

MIFAB	Anaco	Clamp-All	Fernco	Husky	Ideal	Mission	Tyler
MI-HUB	NH	-	NH	-	M8G	C	NH
MI-XHUB	-	Hi-Torq 125	HD	SD4000	H8G	HW	Wide Body

CALIFORNIA PROPOSITION 65 WARNING. This product contains chemicals known to the State of California to cause cancer and birth defects or other reproductive harm.

4 Design and dimensions are subject to modification. Prices do not include applicable taxes. Visit www.mifab.com for the most recent product information.

MIFAB®, Inc., 1321 West 119th Street, Chicago, Illinois 60643-5109, USA
All sales subject to MIFAB's® Terms and Warranties. Please refer to inside front cover.

Toll Free: 1-800-465-2736, Fax: 1-773-341-3049
sales@mifab.com • Canada Toll Free: 1-800-387-3880

MI-HUB-ARC

SHIELDED REPAIR COUPLINGS - CI, PL OR ST TO CI, PL OR ST

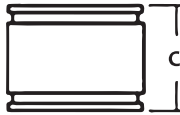

MIFAB's MI-HUB-ARC Series of shielded repair couplings are engineered for resistance to heavy earth loads and shear forces and also provide improved pipe alignment. For Cast Iron, Plastic or Steel pipe to Cast Iron, Plastic or Steel pipe.

Note: Tighten bolts to 60 inch lbs. min. / max torque. Tested to maintain 4.3 p.s.i. maximum line pressure (10' head pressure)

Tested and Certified to ASTM Standard 1173-2010. All models are listed with I.A.P.M.O. (U.P.C.) 5/16" driver required to tighten bolts. All models are listed to the National Plumbing Code of Canada and relevant Canadian Standard(s) and bear the cUPC mark of conformity®. All models are manufactured in compliance with ASTM 1173-2010 and CSA B602-2016. Non constant temperature rating is 140 F. Stainless Steel Clamps and 5/16" hex head bolts are made from Type 300 Stainless Steel.



MODEL NUMBER	PIPE SIZE	A WIDTH	B WIDTH	C HEIGHT	CARTON QUANTITY	PALLET QUANTITY	LIST PRICE, Each Piece
MI-HUB-ARC-33	3" Cast Iron, Plastic or Steel Pipe to 3" Cast iron, Plastic or Steel Pipe.	3.38" (86)	3.38" (86)	4.02" (102)	24	768	\$23.40
MI-HUB-ARC-43	4" Cast Iron, Plastic or Steel Pipe to 3" Cast Iron, Plastic or Steel pipe.	4.58" (116)	3.38" (86)	4.02" (102)	24	768	\$42.40
MI-HUB-ARC-44	4" Cast Iron, Plastic or Steel Pipe to 4" Cast Iron, Plastic or Steel pipe.	4.58" (116)	4.58" (116)	4.02" (102)	24	768	\$29.80
MI-HUB-ARC-55	5" Cast Iron, Plastic or Steel Pipe to 5" Cast Iron, Plastic or Steel pipe.	5.52" (140)	5.52" (140)	3.97" (101)	18	450	\$42.45
MI-HUB-ARC-66	6" Cast Iron, Plastic or Steel Pipe to 6" Cast Iron, Plastic or Steel pipe.	6.60" (168)	6.60" (168)	5.74" (146)	10	300	\$56.75
MI-HUB-ARC-64	6" Cast Iron, Plastic or Steel Pipe to 4" Cast Iron, Plastic or Steel Pipe	6.60" (168)	4.50" (114)	5.74" (146)	10	300	\$73.40
MI-HUB-ARC-88	8" Cast Iron, Plastic or Steel Pipe to 8" Cast Iron, Plastic or Steel Pipe	8.64" (219)	8.64" (219)	6.04" (153)	10	300	\$84.25
MI-HUB-ARC-1010	10" Cast Iron, Plastic or Steel Pipe to 10" Cast Iron, Plastic or Steel Pipe	10.63" (270)	10.63" (270)	5.89" (150)	10	300	\$109.50
MI-HUB-ARC-1212	12" Cast Iron, Plastic or Steel Pipe to 12" Cast Iron, Plastic or Steel Pipe	12.52" (318)	12.52" (318)	6.32" (161)	10	300	\$134.10

CROSS REFERENCE

MIFAB	ANACO	FERNCO	HUSKY	MISSION	PASCO
MI-HUB-ARC-33	-	1056-33RC	-	MR56 33 ARC	5633PRC
MI-HUB-ARC-43	-	1056-44RC	-	MR56 43 ARC	5643PRC
MI-HUB-ARC-44	-	1056-43RC	-	MR56 44 ARC	5644PRC
MI-HUB-ARC-55	-	1056-55RC	-	MR56 55 ARC	5655PRC
MI-HUB-ARC-64	-	1056-64RC	-	MR56 64 ARC	5664PRC
MI-HUB-ARC-66	-	1056-66RC	-	MR56 66 ARC	5666PRC
MI-HUB-ARC-88	-	1056-88RC	-	MR56 88 ARC	5688PRC
MI-HUB-ARC-1010	-	1056-1010RC	-	MR56 1010 ARC	561010PRC
MI-HUB-ARC-1212	-	1056-1212RC	-	MR56 1212 ARC	561212PRC

MI-HUB-ARC-CL

SHIELDED REPAIR COUPLINGS - CL to CI / PL / LD / ST

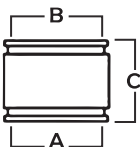

MIFAB's MI-HUB-ARC-CL Series of shielded repair couplings are used to connect clay to cast iron, plastic, lead or steel pipe.

Note: Tighten bolts to 60 inch lbs. min. / max torque. Tested to maintain 4.3 p.s.i. maximum line pressure (10' head pressure)

Tested and Certified to ASTM Standard 1460-2012. All models are listed with I.A.P.M.O. (U.P.C.) 5/16" driver required to tighten bolts. All models are listed to the National Plumbing Code of Canada and relevant Canadian Standard(s) and bear the cUPC mark of conformity®. All models are manufactured in compliance with ASTM 1460-2010 and CSA B602-2016. Non constant temperature rating is 140 F. Stainless Steel Clamps and 5/16" hex head bolts are made from Type 300 Stainless Steel.



MODEL NUMBER	PIPE SIZE	A WIDTH	B WIDTH	C HEIGHT	CARTON QUANTITY	PALLET QUANTITY	LIST PRICE, Each Piece
MI-HUB-ARC-CL-400	4" Clay TO 4" CI / PL / LD / ST	5.36" (136)	4.51" (114)	4.07" (103)	24	768	\$43.65
MI-HUB-ARC-CL-500	5" Clay TO 5" CI / PL / LD / ST	6.60" (167)	5.50" (140)	5.74" (146)	18	450	\$70.00
MI-HUB-ARC-CL-600	6" Clay TO 6" CI / PL / LD / ST	7.50" (191)	6.56" (167)	5.89" (150)	10	300	\$74.00
MI-HUB-ARC-CL-640	6" Clay TO 4" CI / PL / LD / ST	7.50" (191)	4.50" (114)	6.02" (153)	10	300	\$108.75
MI-HUB-ARC-CL-860	8" Clay TO 6" CI / PL / LD / ST	9.65" (245)	6.63" (168)	6" (152)	10	300	\$75.00
MI-HUB-ARC-CL-880	8" Clay TO 8" CI / PL / LD / ST	9.76" (248)	8.57" (218)	5.96" (151)	10	300	\$84.25

SHIELDED NO HUB REPAIR COUPLINGS

MIFAB	ANACO	FERNCO	HUSKY	MISSION	PASCO
MI-HUB-ARC-CL-400	-	1002-44RC	-	MR02 44 ARC	56244
MI-HUB-ARC-CL-500	-	1002-55RC	-	MR02 55 ARC	-
MI-HUB-ARC-CL-600	-	1002-66RC	-	MR02 66 ARC	56266
MI-HUB-ARC-CL-640	-	1002-64RC	-	MR02 64 ARC	56264
MI-HUB-ARC-CL-860	-	1002-86RC	-	MR02 86 ARC	-
MI-HUB-ARC-CL-880	-	1002-88RC	-	MR02 88 ARC	56288

CALIFORNIA PROPOSITION 65 WARNING. This product contains chemicals known to the State of California to cause cancer and birth defects or other reproductive harm.

Design and dimensions are subject to modification. Prices do not include applicable taxes. Visit www.mifab.com for the most recent product information.

MIFAB®, Inc., 1321 West 119th Street, Chicago, Illinois 60643-5109, USA

All sales subject to MIFAB's® Terms and Warranties. Please refer to inside front cover.

Toll Free: 1-800-465-2736, Fax: 1-773-341-3049

sales@mifab.com • Canada Toll Free: 1-800-387-3880

MI-FLEX FLEXIBLE COUPLINGS CI, PL, ST or LD to CI, PL, ST, or LD



MIFAB's MI-FLEX Series of flexible rubber couplings are used to connect cast iron, plastic, steel or lead pipe to cast iron, plastic, steel or lead pipe.

Note: Tighten bolts to 60 inch lbs. min. / max torque. Tested to maintain 4.3 p.s.i. maximum line pressure (10' head pressure) Tested and Certified to ASTM Standard 1173-2010. All models are listed with I.A.P.M.O. (U.P.C.) 5/16" driver required to tighten bolts.

All models are listed to the National Plumbing Code of Canada and relevant Canadian Standard(s) and bear the cUPC mark of conformity®. All models are manufactured in compliance with ASTM 1173-2010 and CSA B602-2016. Non constant temperature rating is 140 F. Stainless Steel Clamps and 5/16" hex head bolts are made from Type 300 Stainless Steel.

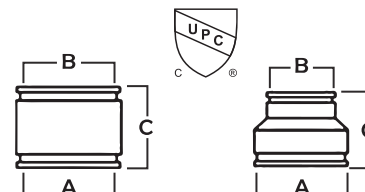

MODEL NUMBER	PIPE SIZE	A		B		C HEIGHT	CARTON QUANTITY	PALLET QUANTITY	LIST PRICE, Each Piece
		MIN	MAX	MIN	MAX				
MI-FLEX-125	1 1/2" Tubing / Copper or 1 1/4" PL / ST / LD x 1 1/4" PL / ST / LD Flex coupling	1.42" (36)	1.69" (43)	1.42" (36)	1.69" (43)	3.50" (89)	100	4,500	\$9.40
MI-FLEX-15125	1 1/2" CI / PL / ST / LD x 1 1/2" Tubing, Copper or 1 1/4" PL / ST / LD Flex coupling	1.73" (44)	1.97" (50)	1.34" (34)	1.69" (43)	3.50" (89)	100	4,500	\$10.40
MI-FLEX-150	1 1/2" CI / PL / ST / LD x 1 1/2" CI / PL / ST / LD Flex coupling	1.73" (44)	2" (52)	1.73" (44)	2" (52)	3.50" (89)	100	4,500	\$10.05
MI-FLEX-200	2" CI / PL / ST / LD x 2" CI / PL / ST / LD Flex coupling	2.20" (56)	2.50" (64)	2.20" (56)	2.50" (64)	3.50" (89)	100	2,200	\$10.80
MI-FLEX-215	2" CI / PL / ST / LD x 1 1/2" CI / PL / ST / LD Flex coupling	2.13" (54)	2.50" (64)	1.70" (43)	1.97" (50)	3.50" (89)	100	3,200	\$11.40
MI-FLEX-300	3" CI / PL / ST / LD x 3" CI / PL / ST / LD Flex coupling	2.60" (66)	3.18" (81)	2.60" (66)	3.18" (81)	2.75" (70)	80	1,920	\$14.60
MI-FLEX-320	3" CI / PL / ST / LD x 2" CI / PL / ST / LD Flex coupling	2.60" (66)	3.18" (81)	2.20" (56)	2.50" (64)	2.75" (70)	90	2,160	\$13.50
MI-FLEX-400	4" CI / PL / ST / LD x 4" CI / PL / ST / LD Flex coupling	4.02" (102)	4.65" (118)	4.02" (102)	4.65" (118)	4" (102)	60	1,320	\$18.25
MI-FLEX-415	4" CI / PL / ST / LD x 1 1/2" CI / PL / ST / LD Flex coupling	4.02" (102)	4.50" (114)	1.73" (44)	1.97" (50)	4" (102)	60	1,800	\$28.00
MI-FLEX-420	4" CI / PL / ST / LD x 2" CI / PL / ST / LD Flex coupling	4.02" (102)	4.50" (114)	2.20" (56)	2.50" (64)	4" (102)	60	1,800	\$25.50
MI-FLEX-430	4" CI / PL / ST / LD x 3" CI / PL / ST / LD Flex coupling	4.02" (102)	4.50" (114)	2.60" (66)	3.18" (81)	4" (102)	60	1,440	\$19.70
MI-FLEX-500	5" CI / PL / ST / LD x 5" CI / PL / ST / LD Flex coupling	5.20" (132)	5.70" (145)	5.20" (132)	5.70" (145)	4" (102)	30	720	\$30.90
MI-FLEX-540	5" CI / PL / ST / LD x 4" CI / PL / ST / LD Flex coupling	5.25" (133)	5.66" (144)	3.87" (98)	4.33" (110)	4" (102)	30	720	\$34.40
MI-FLEX-600	6" CI / PL / ST / LD x 6" CI / PL / ST / LD Flex coupling	6.30" (160)	6.69" (170)	6.30" (160)	6.69" (170)	6" (152)	18	432	\$39.10
MI-FLEX-640	6" CI / PL / ST / LD x 4" CI / PL / ST / LD Flex coupling	6.29" (160)	6.75" (171)	4.08" (104)	4.55" (116)	5.75" (146)	30	720	\$45.90
MI-FLEX-650	6" CI / PL / ST / LD x 5" CI / PL / ST / LD Flex coupling	5.97" (152)	6.54" (166)	5.15" (131)	5.65" (144)	5.75" (146)	30	720	\$48.60
MI-FLEX-800	8" CI / PL / ST / LD x 8" CI / PL / ST / LD Flex coupling	8" (203)	8.74" (222)	8" (203)	8.74" (222)	6" (152)	10	240	\$60.10
MI-FLEX-840	8" CI / PL / ST / LD x 4" CI / PL / ST / LD Flex coupling	8" (203)	8.74" (222)	4.02" (102)	4.65" (118)	6" (152)	10	240	\$99.35
MI-FLEX-860	8" CI / PL / ST / LD x 6" CI / PL / ST / LD Flex coupling	8.05" (204)	8.60" (218)	5.85" (149)	6.38" (162)	6" (152)	10	240	\$72.60
MI-FLEX-1000	10" CI / PL / ST / LD x 10" CI / PL / ST / LD Flex coupling	10.10" (257)	10.78" (274)	10.24" (260)	10.78" (274)	6" (152)	8	192	\$90.25
MI-FLEX-1008	10" CI / PL / ST / LD x 8" CI / PL / ST / LD Flex coupling	9.60" (244)	10.40" (264)	7.75" (197)	8.56" (217)	6" (152)	8	192	\$98.85
MI-FLEX-1200	12" CI / PL / ST / LD x 12" CI / PL / ST / LD Flex coupling	12.05" (306)	12.65" (321)	12.05" (306)	12.65" (321)	6" (152)	4	44	\$105.30

CROSS REFERENCE

MIFAB	ANACO	FERNCO	HUSKY	MISSION	PASCO
MI-FLEX-125	-	1056-125	-	MR 56 125	56125
MI-FLEX-15125	-	1056-15125	-	MR 56 15125	5615125
MI-FLEX-150	6011	1056-150	6011	MR 56 15	5615
MI-FLEX-200	6023	1056-22	6023	MR 56 22	5622
MI-FLEX-215	6021	1056-215	6021	MR 56 215	56215
MI-FLEX-300	6035	1056-33	6035	MR 56 33	5633
MI-FLEX-320	6033	1056-32	6033	MR 56 32	5632
MI-FLEX-400	6043	1056-44	6043	MR 56 44	5644
MI-FLEX-415	-	1056-415	-	MR 56 415	56415
MI-FLEX-420	6040	1056-42	6040	MR 56 42	5642
MI-FLEX-430	6041	1056-43	6041	MR 56 43	5643
MI-FLEX-500	-	1056-55	-	MR 56 55	5655
MI-FLEX-540	-	1056-540	-	MR 56 54	5654
MI-FLEX-600	-	1056-66	-	MR 56 66	5666
MI-FLEX-640	-	1056-64	-	MR 56 64	5664
MI-FLEX-650	-	1056-65	-	MR 56 65	5665
MI-FLEX-800	-	1056-88	-	MR 56 88	5688
MI-FLEX-840	-	1056-84	-	MR 56 84	5684
MI-FLEX-860	-	1056-86	-	MR 56 86	5686
MI-FLEX-1000	-	1056-1010	-	MR 56 1010	561010
MI-FLEX-1008	-	1056-1008	-	MR 56 1008	561008
MI-FLEX-1200	-	1056-1212	-	MR 56 1212	561212

CALIFORNIA PROPOSITION 65 WARNING. This product contains chemicals known to the State of California to cause cancer and birth defects or other reproductive harm.

MI-FLEX-CC FLEXIBLE COUPLINGS - CONCRETE TO CI OR PLASTIC

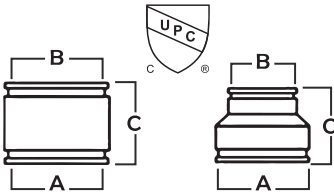

MIFAB's MI-FLEX-CC Series of flexible rubber couplings are used to connect concrete pipe to cast iron or plastic pipe.

Note: Tighten bolts to 60 inch lbs. min. / max torque. Tested to maintain 4.3 p.s.i. maximum line pressure (10' head pressure). Tested and Certified to ASTM Standard 1173-2010. All models are listed with I.A.P.M.O. (U.P.C.). 5/16" driver required to tighten bolts.

All models are listed to the National Plumbing Code of Canada and relevant Canadian Standard(s) and bear the cUPC mark of conformity. All models are manufactured in compliance with ASTM 1173-2010. Non constant temperature rating is 140 F. Stainless Steel Clamps and 5/16" hex head bolts are made from Type 300 Stainless Steel.



"We might be a small outfit but we still know quality. MIFAB's couplings are high quality - they always have been."
 - Malcolm Enos, Denos Plumbing & Heating, Markham, Ontario, Canada

MODEL NUMBER	PIPE SIZE	A		B		C HEIGHT	CARTON QUANTITY	PALLET QUANTITY	LIST PRICE, Each Piece
		MIN	MAX	MIN	MAX				
MI-FLEX-CC-400	4" Concrete x 4" CI / PL coupling	5.56" (141)	6.27" (159)	4.30" (109)	5.02" (128)	3.95" (100)	60	1,200	\$36.75
MI-FLEX-CC-600	6" Concrete x 6" CI / PL coupling	7.78" (197)	8.49" (215)	6.38" (162)	7.10" (180)	5.81" (148)	20	400	\$43.25
MI-FLEX-CC-640	6" Concrete x 4" CI / PL coupling	7.75" (197)	8.55" (217)	4.31" (109)	5.10" (130)	5.91" (150)	20	500	\$45.90

CROSS REFERENCE

MIFAB	ANACO	FERNCO	HUSKY	MISSION	PASCO
MI-FLEX-CC-400	-	1006-44	-	MR 06 44	56644
MI-FLEX-CC-600	-	1006-66	-	MR 06 66	56666
MI-FLEX-CC-640	-	1006-64	-	MR 06 64	56664

MI-FLEX-CL FLEXIBLE COUPLINGS - CLAY TO CI OR PLASTIC

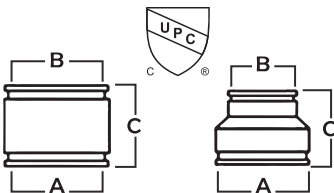

MIFAB's MI-FLEX-CL Series of flexible rubber couplings are used to connect clay pipe to cast iron or plastic pipe.

Note: Tighten bolts to 60 inch lbs. min. / max torque. Tested to maintain 4.3 p.s.i. maximum line pressure (10' head pressure). Tested and Certified to ASTM Standard 1173-2010. All models are listed with I.A.P.M.O. (U.P.C.) 5/16" driver required to tighten bolts.

All models are listed to the National Plumbing Code of Canada and relevant Canadian Standard(s) and bear the cUPC mark of conformity. All models are manufactured in compliance with ASTM 1173-2010 and CSA B602-2016. Non constant temperature rating is 140 F. Stainless Steel Clamps and 5/16" hex head bolts are made from Type 300 Stainless Steel.



MODEL NUMBER	PIPE SIZE	A		B		C HEIGHT	CARTON QUANTITY	PALLET QUANTITY	LIST PRICE, Each Piece
		MIN	MAX	MIN	MAX				
MI-FLEX-CL-400	4" Clay x 4" CI / PL Flexible coupling	4.75" (121)	5.38" (137)	4" (102)	4.63" (118)	4" (102)	60	1,200	\$18.25
MI-FLEX-CL-500	5" Clay x 5" CI / PL Flexible coupling	5.61" (142)	6.20" (157)	5.15" (131)	5.65" (144)	5" (127)	30	360	\$30.95
MI-FLEX-CL-640	6" Clay x 4" CI / PL Flexible coupling	7" (178)	7.56" (192)	3.87" (98)	4.41" (112)	5 1/2" (140)	20	500	\$45.90
MI-FLEX-CL-600	6" Clay x 6" CI / PL Flexible coupling	7.05" (179)	7.56" (192)	6.15" (156)	6.69" (170)	6" (152)	20	400	\$39.10
MI-FLEX-CL-860	8" Clay x 6" CI / PL Flexible coupling	8.80" (224)	9.43" (240)	5.90" (150)	6.31" (160)	6" (152)	8	192	\$74.60
MI-FLEX-CL-800	8" Clay x 8" CI / PL Flexible coupling	9.10" (231)	9.90" (251)	7.87" (200)	8.75" (222)	6" (152)	8	192	\$60.10
MI-FLEX-CL-1000	10" Clay x 10" CI / PL Flexible coupling	11.75" (298)	12.70" (323)	9.75" (248)	10.75" (273)	5.75" (146)	8	88	\$90.25

CROSS REFERENCE

MIFAB	ANACO	FERNCO	HUSKY	MISSION	PASCO
MI-FLEX-CL-400	-	1002-44	-	MR 02 44	56244
MI-FLEX-CL-500	-	1002-55	-	MR 02 55	-
MI-FLEX-CL-640	-	1002-64	-	MR 02 64	56264
MI-FLEX-CL-600	-	1002-66	-	MR 02 66	56266
MI-FLEX-CL-860	-	1002-86	-	MR 02 86	-
MI-FLEX-CL-800	-	1002-88	-	MR 02 88	56288
MI-FLEX-CL-1000	-	1002-1010	-	MR 02 1010	5621010

CALIFORNIA PROPOSITION 65 WARNING. This product contains chemicals known to the State of California to cause cancer and birth defects or other reproductive harm.

Design and dimensions are subject to modification. Prices do not include applicable taxes. Visit www.mifab.com for the most recent product information.

MIFAB®, Inc., 1321 West 119th Street, Chicago, Illinois 60643-5109, USA

Toll Free: 1-800-465-2736, Fax: 1-773-341-3049

All sales subject to MIFAB's® Terms and Warranties. Please refer to inside front cover.

sales@mifab.com • Canada Toll Free: 1-800-387-3880

MI-FLEX-EXP

EXPANSION JOINTS

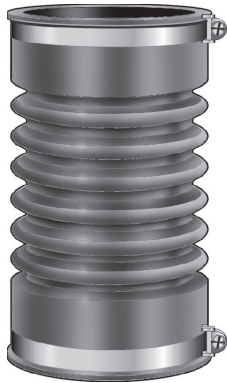

MIFAB's MI-FLEX-EXP Series of expansion joints are used to connect cast iron or plastic to cast iron or plastic pipe.

Note: Tighten bolts to 60 inch lbs. min. / max torque. Tested to maintain

4.3 p.s.i. maximum line pressure (10' head pressure)

5/16" driver required to tighten bolts.

"I've been ordering MIFAB MI-HUB no hub couplings for the past 5 years. They make the ordering process simple and easy to do business with."

— Bruce Hanson, Tri Rep Sales, Houston, TX

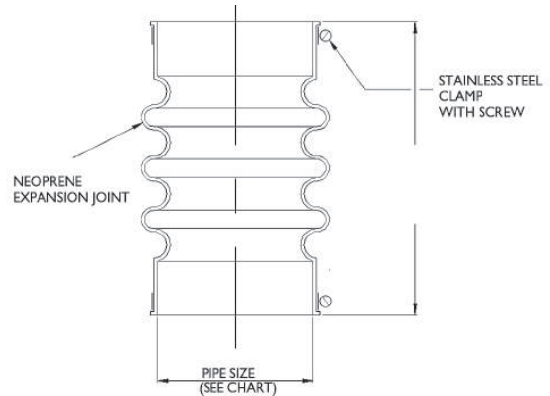

MODEL NUMBER	PIPE SIZE	C HEIGHT	LIST PRICE, Each Piece
MI-FLEX-EXP-2	2" x 2"	7 1/8"	\$44.00
MI-FLEX-EXP-3	3" x 3"	8 1/8"	\$48.00
MI-FLEX-EXP-4	4" x 4"	8 5/8"	\$60.00
MI-FLEX-EXP-6	6" x 6"	8 5/8"	\$80.00
MI-FLEX-EXP-8	8" x 8"	11"	\$135.00

CROSS REFERENCE

MIFAB	ANACO	FERNCO	HUSKY	MISSION	PASCO
MI-FLEX-EXP-2	-	XJ-2	-	MR56 22EXP	-
MI-FLEX-EXP-3	-	XJ-3	-	MR56 33EXP	-
MI-FLEX-EXP-4	-	XJ-4	-	MR56 44EXP	-
MI-FLEX-EXP-6	-	-	-	-	-
MI-FLEX-EXP-8	-	-	-	-	-

MI-HUB-TRS

SHIELDED TRANSITION COUPLINGS - PL / ST OR XHCI TO COPPER



MIFAB's MI-HUB-TRS Series of shielded transition couplings are used to connect plastic, steel, or extra heavy cast iron pipe to copper pipe.

Note: Tighten bolts to 60 inch lbs. min. / max torque. Tested to maintain 4.3 p.s.i. maximum line pressure (10' head pressure)

Tested and Certified to ASTM Standard 1460-2012. All models are listed with I.A.P.M.O. (U.P.C.) 5/16" driver required to tighten bolts. All models are listed to the National Plumbing Code of Canada and relevant Canadian Standard(s) and bear the cUPC mark of conformity®. All models are manufactured in compliance with ASTM 1460-2010 and CSA B602-2016. Non constant temperature rating is 140 F. Stainless Steel Clamps and 5/16" hex head bolts are made from Type 300 Stainless Steel.

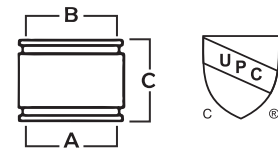

MODEL NUMBER	PIPE SIZE	A WIDTH	B WIDTH	C HEIGHT	CARTON QUANTITY	PALLET QUANTITY	LIST PRICE, Each Piece
MI-HUB-TRS-330	3" Plastic, Steel or Extra Heavy Cast Iron TO 3" Copper	3.37" (86)	3.52" (89)	2.13" (54)	100	2,400	\$13.00
MI-HUB-TRS-440	4" Plastic, Steel or Extra Heavy Cast Iron TO 4" Copper	4.36" (111)	4.44" (113)	2.13" (54)	100	2,400	\$17.75

CROSS REFERENCE

MIFAB	ANACO	FERNCO	HUSKY	MISSION	PASCO
MI-HUB-TRS-330	-	3007-33	-	PK-33	5833-PK
MI-HUB-TRS-440	-	3007-44	-	PK-44	5844-PK

CALIFORNIA PROPOSITION 65 WARNING. This product contains chemicals known to the State of California to cause cancer and birth defects or other reproductive harm.

MI-HUB-TR

SHIELDED TRANSITION COUPLINGS - CI, PL OR ST TO CI, PL OR ST.

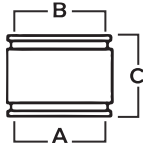

MIFAB's MI-HUB-TR Series of shielded transition couplings are used to connect cast iron, plastic or steel pipe to cast iron, plastic or steel pipe.

Note: Tighten bolts to 60 inch lbs. min. / max torque. Tested to maintain 4.3 p.s.i. maximum line pressure (10' head pressure) Tested and Certified to ASTM Standard 1460-2012. All models are listed with I.A.P.M.O. (U.P.C.) 5/16" driver required to tighten bolts. All models are listed to the National Plumbing Code of Canada and relevant Canadian Standard(s) and bear the cUPC mark of conformity®. All models are manufactured in compliance with ASTM 1460-2012 and CSA B602-2016. Non constant temperature rating is 140 F. Stainless Steel Clamps and 5/16" hex head bolts are made from Type 300 Stainless Steel.



MODEL NUMBER	PIPE SIZE	A WIDTH	B WIDTH	C HEIGHT	CARTON QUANTITY	PALLET QUANTITY	LIST PRICE, Each Piece
MI-HUB-TR-150	1 1/2" CI / PL / ST x 1 1/2" CI / PL / ST- Shielded Transition coupling	1.95" (50)	1.95" (50)	2.13" (54)	100	7,200	\$7.25
MI-HUB-TR-200	2" CI / PL / ST x 2" CI / PL / ST- Shielded Transition coupling	2.28" (58)	2.34" (59)	2.13" (54)	100	4,800	\$7.25
MI-HUB-TR-215	2" CI / PL / ST x 1 1/2" CI / PL / ST- Shielded Transition coupling	1.93" (49)	2.40" (61)	2.13" (54)	100	4,800	\$9.70
MI-HUB-TR-330	3" CI / PL / ST x 3" CI / PL / ST- Shielded Transition coupling	3.37" (86)	3.52" (89)	2.13" (54)	100	2,400	\$11.10
MI-HUB-TR-430	4" CI / PL / ST x 3" CI / PL / ST - Shielded Transition Coupling	4.46" (113)	3.46" (88)	2.13" (54)	100	2,400	\$16.20
MI-HUB-TR-440	4" CI x 4" CI / PL / ST- Shielded Transition coupling	4.36" (111)	4.44" (113)	2.13" (54)	100	2,400	\$12.10
MI-HUB-TR-550	5" CI x 5" CI / PL / ST- Shielded Transition coupling	5" (127)	5.18" (132)	3" (76)	30	720	\$26.05
MI-HUB-TR-660	6" CI x 6" CI / PL / ST- Shielded Transition coupling	6.52" (166)	6.15" (156)	3" (76)	30	720	\$34.85
MI-HUB-TR-880	8" CI x 8" CI / PL / ST- Shielded Transition coupling	8.50" (216)	8.31" (211)	3.81" (97)	20	320	\$47.40

CROSS REFERENCE

MIFAB	ANACO	FERNCO	HUSKY	MISSION	PASCO
MI-HUB-TR-150	5010-C	3000-150	5010-C	CP150	58150CP
MI-HUB-TR-200	5020-C	3000-22	5020-C	CP200	58200CP
MI-HUB-TR-215	5023-C	3000-215	5023-C	CP215	58215CP
MI-HUB-TR-330	5030-C	3000-33	5030-C	CP33	5833CP
MI-HUB-TR-430	5041-C	3000-43	5041-C	CP43	-
MI-HUB-TR-440	5040-C	3000-44	5040-C	CP44	5844CP
MI-HUB-TR-550	5050-C	3000-55	5050-C	CP55	5855CP
MI-HUB-TR-660	5060-C	3000-66	5060-C	CP66	5866CP
MI-HUB-TR-880	5080-C	3000-88	5080-C	CP88	5888CP

MI-HUB-TRC

SHIELDED TRANSITION COUPLINGS - CI, PL OR ST TO COPPER OR PL.

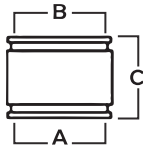

MIFAB's MI-HUB-TRC Series of shielded transition couplings are used to connect cast iron, plastic or steel pipe to copper or plastic pipe.

Note: Tighten bolts to 60 inch lbs. min. / max torque. Tested to maintain 4.3 p.s.i. maximum line pressure (10' head pressure). Tested and Certified to ASTM Standard 1460-2012. All models are listed with I.A.P.M.O. (U.P.C.) 5/16" driver required to tighten bolts. All models are listed to the National Plumbing Code of Canada and relevant Canadian Standard(s) and bear the cUPC mark of conformity®. All models are manufactured in compliance with ASTM 1460-2012 and CSA B602-2016. Non constant temperature rating is 140 F. Stainless Steel Clamps and 5/16" hex head bolts are made from Type 300 Stainless Steel.



MODEL NUMBER	PIPE SIZE	A WIDTH	B WIDTH	C HEIGHT	CARTON QUANTITY	PALLET QUANTITY	LIST PRICE, Each Piece
MI-HUB-TRC-1125	1 1/2" CI / PL / ST x 1 1/4" Copper or 1 1/4" PL - Shielded Transition coupling	1.91" (49)	1.35" (34)	2.13" (54)	100	7,200	\$11.75
MI-HUB-TRC-150	1 1/2" CI / PL / ST x 1 1/2" Copper or 1 1/4" PL - Shielded Transition coupling	1.95" (50)	1.64" (42)	2.13" (54)	100	7,200	\$10.15
MI-HUB-TRC-2125	2" CI / PL / ST x 1 1/4" Copper or 1" PL - Shielded Transition coupling	2.36" (60)	1.29" (33)	2.13" (54)	100	4,800	\$17.00
MI-HUB-TRC-215	1 1/2" CI / PL / ST x 2" Copper or 2" PL - Shielded Transition coupling	1.93" (49)	2.40" (61)	2.13" (54)	100	4,800	\$10.15
MI-HUB-TRC-220	2" CI / PL / ST x 2" Copper - Shielded Transition coupling	2.28" (58)	2.34" (59)	2.13" (54)	100	4,800	\$13.35
MI-HUB-TRC-320	3" CI x 2" Copper - Shielded Transition coupling	3.37" (86)	2.34" (59)	2.13" (54)	100	2,400	\$15.10
MI-HUB-TRC-330	3" CI x 3" Copper - Shielded Transition coupling	3.37" (86)	3.52" (89)	2.13" (54)	100	2,400	\$14.35
MI-HUB-TRC-430	4" CI x 3" Copper - Shielded Transition coupling	4.46" (113)	3.46" (88)	2.13" (54)	100	2,400	\$15.35
MI-HUB-TRC-440	4" CI x 4" Copper - Shielded Transition coupling	4.36" (111)	4.44" (113)	2.13" (54)	100	2,400	\$15.10

CROSS REFERENCE

MIFAB	ANACO	FERNCO	HUSKY	MISSION	PASCO
MI-HUB-TRC-1125	5010-C	3001-1125	5010-C	CK1125	581125CK
MI-HUB-TRC-150	5011-C	3001-150	5011-C	CK115	58115CK
MI-HUB-TRC-2125	5024-C	3001-2125	5024-C	CK2125	582125CK
MI-HUB-TRC-215	5022-C	3001-215	5022-C	CK215	58215CK
MI-HUB-TRC-220	5021-C	3001-22	5021-C	CK22	5822CK
MI-HUB-TRC-320	5031-C	3001-32	5031-C	CK32	5832CK
MI-HUB-TRC-330	5032-C	3001-33	5032-C	CK33	5833CK
MI-HUB-TRC-430	5043-C	3001-43	5043-C	CK43	5843CK
MI-HUB-TRC-440	5044-C	3001-44	5044-C	CK44	5844CK

CALIFORNIA PROPOSITION 65 WARNING. This product contains chemicals known to the State of California to cause cancer and birth defects or other reproductive harm.

Design and dimensions are subject to modification. Prices do not include applicable taxes. Visit www.mifab.com for the most recent product information.

MIFAB®, Inc., 1321 West 119th Street, Chicago, Illinois 60643-5109, USA

Toll Free: 1-800-465-2736, Fax: 1-773-341-3049

All sales subject to MIFAB's® Terms and Warranties. Please refer to inside front cover.

sales@mifab.com • Canada Toll Free: 1-800-387-3880

MI-HUB-TRP

SHIELDED TRANSITION COUPLINGS - PL, ST, XHCI TO PL, ST OR XHCI



MIFAB's MI-HUB-TRP Series of shielded transition couplings are used to connect plastic, steel or extra heavy cast iron pipe to plastic, steel or extra heavy cast iron pipe.

Note: Tighten bolts to 60 inch lbs. min. / max torque. Tested to maintain 4.3 p.s.i. maximum line pressure (10' head pressure).

Tested and Certified to ASTM Standard 1460-2012. All models are listed with I.A.P.M.O. (U.P.C.) 5/16" driver required to tighten bolts. All models are listed to the National Plumbing Code of Canada and relevant Canadian Standard(s) and bear the cUPC mark of conformity®. All models are manufactured in compliance with ASTM 1460-2012 and CSA B602-2016. Non constant temperature rating is 140 F. Stainless Steel Clamps and 5/16" hex head bolts are made from Type 300 Stainless Steel.

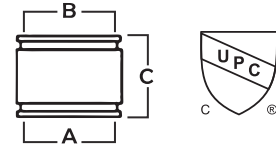

MODEL NUMBER	PIPE SIZE	A WIDTH	B WIDTH	C HEIGHT	CARTON QUANTITY	PALLET QUANTITY	LIST PRICE, Each Piece
MI-HUB-TRP-330	3" PL / ST or XH CI x 3" PL / ST, or XH CI - Shielded Transition coupling	3.37" (86)	3.52" (89)	2.13" (54)	100	2,400	\$11.65
MI-HUB-TRP-430	4" PL / ST or XH CI x 3" PL / ST, or XH CI - Shielded Transition coupling	4.46" (113)	3.46" (88)	2.13" (54)	100	2,400	\$15.00
MI-HUB-TRP-440	4" PL / ST or XH CI x 4" PL / ST, or XH CI - Shielded Transition coupling	4.36" (111)	4.44" (113)	2.13" (54)	100	2,400	\$13.60
MI-HUB-TRP-660	6" PL / ST or XH CI x 6" PL / ST, or XH CI - Shielded Transition coupling	6.52" (166)	6.15" (156)	3" (76)	100	2,400	\$34.85

CROSS REFERENCE

MIFAB	ANACO	FERNCO	HUSKY	MISSION	PASCO
MI-HUB-TRP-330	5304-C	3005-33	5304-C	P-300	58300P
MI-HUB-TRP-430	5406-C	3005-43	5406-C	P-430	58430P
MI-HUB-TRP-440	5405-C	3005-44	5405-C	P-400	58400P
MI-HUB-TRP-660	5601-C	3005-66	5601-C	P-600	58600P

MI-HUB-TRT

SHIELDED TRANSITION COUPLINGS - CI, PL OR ST TO TUBULAR



MIFAB's MI-HUB-TRT Series of shielded transition couplings are used to connect cast iron, plastic or steel pipe to tubular pipe.

Note: Tighten bolts to 60 inch lbs. min. / max torque. Tested to maintain 4.3 p.s.i. maximum line pressure (10' head pressure)

Tested and Certified to ASTM Standard 1460-2012. All models are listed with I.A.P.M.O. (U.P.C.) 5/16" driver required to tighten bolts. All models are listed to the National Plumbing Code of Canada and relevant Canadian Standard(s) and bear the cUPC mark of conformity®. All models are manufactured in compliance with ASTM 1460-2012 and CSA B602-2016. Non constant temperature rating is 140 F. Stainless Steel Clamps and 5/16" hex head bolts are made from Type 300 Stainless Steel.

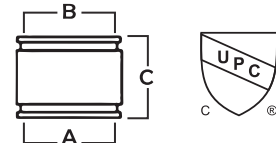

MODEL NUMBER	PIPE SIZE	A WIDTH	B WIDTH	C HEIGHT	CARTON QUANTITY	PALLET QUANTITY	LIST PRICE, Each Piece
MI-HUB-TRT-150	1 1/2" CI / PL / ST x 1 1/2" Tubular - Shielded Transition coupling	1.95" (50)	1.64" (42)	2.13" (54)	100	4,800	\$11.90
MI-HUB-TRT-155	1 1/2" Tubular x 1 1/2" Tubular - Shielded Transition coupling	1.95" (50)	1.64" (42)	2.13" (54)	100	4,800	\$13.80
MI-HUB-TRT-215	2" CI / PL / ST x 1 1/2" Tubular - Shielded Transition coupling	1.93" (49)	2.40" (61)	2.13" (54)	100	4,800	\$13.35

CROSS REFERENCE

MIFAB	ANACO	FERNCO	HUSKY	MISSION	PASCO
MI-HUB-TRT-150	5108-C	3002-150	5108-C	T-150	58150T
MI-HUB-TRT-155	5109-C	3002-155	5109-C	BWT-150	58150BWT
MI-HUB-TRT-215	5210-C	3002-215	5210-C	T-215	58215T

CALIFORNIA PROPOSITION 65 WARNING. This product contains chemicals known to the State of California to cause cancer and birth defects or other reproductive harm.

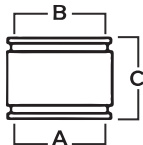
MI-HUB-TRCC
SHIELDED TRANSITION COUPLINGS - Copper to Copper or PL

MIFAB's MI-HUB-TRCC Series of shielded transition couplings are used to connect copper pipe to copper or plastic pipe.

Note: Tighten bolts to 60 inch lbs. min. / max torque. Tested to maintain 4.3 p.s.i. maximum line pressure (10' head pressure)

Tested and Certified to ASTM Standard 1460-2012. All models are listed with I.A.P.M.O. (U.P.C.) 5/16" driver required to tighten bolts. All models are listed to the National Plumbing Code of Canada and relevant Canadian Standard(s) and bear the cUPC mark of conformity. All models are manufactured in compliance with ASTM 1460-2010 and CSA B602-2016. Non constant temperature rating is 140 F. Stainless Steel Clamps and 5/16" hex head bolts are made from Type 300 Stainless Steel.



"MIFAB's no hub couplings were in the specifications and the pricing was competitive."

– Anthony J. Lampuri, ABL Mechanical, Raleigh, NC

MODEL NUMBER	PIPE SIZE	A WIDTH	B WIDTH	C HEIGHT	CARTON QUANTITY	PALLET QUANTITY	LIST PRICE, Each Piece
MI-HUB-TRCC-1125	1 1/2" Copper or 1 1/4" Plastic TO 1 1/4" Copper or 1" Plastic	1.91" (49)	1.35" (34)	2.13" (54)	100	7,200	\$18.00
MI-HUB-TRCC-150	1 1/2" Copper or 1 1/4" Plastic TO 1 1/2" Copper or 1 1/4" Plastic	1.95" (50)	1.64" (42)	2.13" (54)	100	7,200	\$11.00
MI-HUB-TRCC-215	2" Copper TO 1 1/2" Copper or 1 1/4" Plastic	1.93" (49)	2.40" (61)	2.13" (54)	100	7,200	\$11.75
MI-HUB-TRCC-220	2" Copper TO 2" Copper	2.28" (58)	2.34" (59)	2.13" (54)	100	7,200	\$11.75
MI-HUB-TRCC-330	3" Copper TO 3" Copper	3.37" (86)	3.52" (89)	2.13" (54)	100	7,200	\$13.40

CROSS REFERENCE

MIFAB	ANACO	FERNCO	HUSKY	MISSION	PASCO
MI-HUB-TRCC-1125	-	-	-	K1125	-
MI-HUB-TRCC-150	-	3003-150	-	K150	58150K
MI-HUB-TRCC-215	-	3003-215	-	K215	58215K
MI-HUB-TRCC-220	-	3003-22	-	K200	58200K
MI-HUB-TRCC-300	-	3003-33	-	K300	58300K

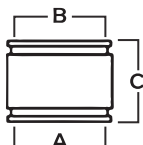
MI-HUB-TRTW
SHIELDED TRANSITION COUPLINGS - THINWALL PL TO SCH. 40 PL OR ST

MIFAB's MI-HUB-TRTW Series of shielded transition couplings are used to connect thinwall plastic to Schedule 40 plastic plastic or steel pipe.

Note: Tighten bolts to 60 inch lbs. min. / max torque. Tested to maintain 4.3 p.s.i. maximum line pressure (10' head pressure)

Tested and Certified to ASTM Standard 1460-2012. All models are listed with I.A.P.M.O. (U.P.C.) 5/16" driver required to tighten bolts. All models are listed to the National Plumbing Code of Canada and relevant Canadian Standard(s) and bear the cUPC mark of conformity. All models are manufactured in compliance with ASTM 1460-2010 and CSA B602-2016. Non constant temperature rating is 140 F. Stainless Steel Clamps and 5/16" hex head bolts are made from Type 300 Stainless Steel.



MODEL NUMBER	PIPE SIZE	A WIDTH	B WIDTH	C HEIGHT	CARTON QUANTITY	PALLET QUANTITY	LIST PRICE, Each Piece
MI-HUB-TRTW-440	4" Thinwall Plastic TO 4" Schedule 40 Plastic or Steel	4.36" (111)	4.44" (113)	2.13" (54)	100	2,400	\$12.60

CROSS REFERENCE

MIFAB	ANACO	FERNCO	HUSKY	MISSION	PASCO
MI-HUB-TRTW-440	-	3009-33	-	TWP-44	5844TWP

CALIFORNIA PROPOSITION 65 WARNING. This product contains chemicals known to the State of California to cause cancer and birth defects or other reproductive harm.

Design and dimensions are subject to modification. Prices do not include applicable taxes. Visit www.mifab.com for the most recent product information.

MIFAB®, Inc., 1321 West 119th Street, Chicago, Illinois 60643-5109, USA

All sales subject to MIFAB's® Terms and Warranties. Please refer to inside front cover.

Toll Free: 1-800-465-2736, Fax: 1-773-341-3049
 sales@mifab.com • Canada Toll Free: 1-800-387-3880

MI-FLEX-DISH **DISHWASHER CONNECTOR**



MIFAB's MI-FLEX-DISH connects a dishwasher hose to a sink drain or garbage disposer. They are made out of flexible PVC.

Note: Tighten bolts to 60 inch lbs. min. / max torque. Tested to maintain 4.3 p.s.i. maximum line pressure (10' head pressure)

5/16" driver required to tighten bolts.

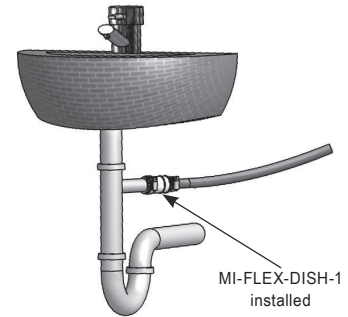

(Typical Installation underneath a sink)

MODEL NUMBER	PIPE SIZE	A WIDTH	B WIDTH	C HEIGHT	CARTON QUANTITY	LIST PRICE, Each Piece
MI-FLEX-DISH-1	.75" or 1" x 1"	.64" (16)	.92" (23)	2.70" (69)	100	\$3.80

CROSS REFERENCE

MIFAB	ANACO	FERNCO	HUSKY	MISSION	PASCO
MI-FLEX-DISH-1	-	DWC-100	-	MRDWC 150	496

MI-FLEX-DTC **FLEXIBLE COUPLINGS - TUBULAR TO DRAIN PIPE**



MIFAB's MI-FLEX-DTC Series of flexible rubber couplings are used to connect tubular traps to common household drain pipe for new installation, repairs and alterations.

Note: Tighten bolts to 60 inch lbs. min. / max torque. Tested to maintain 4.3 p.s.i. maximum line pressure (10' head pressure)

Tested and Certified to ASTM Standard 1173-2010. All models are listed with I.A.P.M.O. (U.P.C.) 5/16" driver required to tighten bolts. All models are listed to the National Plumbing Code of Canada and relevant Canadian Standard(s) and bear the cUPC mark of conformity®. All models are manufactured in compliance with ASTM 1173-2010 and CSA B602-2016. Non constant temperature rating is 140 F.

Stainless Steel Clamps and 5/16" hex head bolts are made from Type 300 Stainless Steel.



MODEL NUMBER	PIPE SIZE	A		B		C HEIGHT	CARTON QUANTITY	PALLET QUANTITY	LIST PRICE, Each Piece
		MIN	MAX	MIN	MAX				
MI-FLEX-DTC-150	1 1/4" or 1 1/2" tubular traps to 1 1/4" or 1 1/2" drain piping	1.46" (37)	1.69" (43)	1.95" (50)	2.16" (55)	2.25" (57)	100	6,300	\$6.35
MI-FLEX-DTC-215	1 1/4" or 1 1/2" tubular traps to 2" drain piping (except copper. For 2" copper, use MI-FLEX-DTC-150).	1.46" (37)	1.70" (43)	2.38" (61)	2.62" (67)	2.31" (59)	100	6,300	\$10.30

CROSS REFERENCE

MIFAB	ANACO	FERNCO	HUSKY	MISSION	PASCO
MI-FLEX-DTC-150	-	DTC-150	-	MRTC 150	5915
MI-FLEX-DTC-215	-	DTC-215	-	MRDTC 215	5925

CALIFORNIA PROPOSITION 65 WARNING. This product contains chemicals known to the State of California to cause cancer and birth defects or other reproductive harm.

C1440-NH

EXPANDABLE MECHANICAL STOPPERS



MIFAB's C1440-NH Series of expandable mechanical stoppers are used to test gravity flow, non pressure DWV and sewer systems.

The plastic plug will expand into the pipe opening as it is tightened. The C1440-NH Series meet and exceed the ASTM Standard C425 requirements.

"We love the ease of use of MIFAB's no hub couplings. They save us money on labor costs during all of our projects."

– Paul Weisenberg, Weisenberg Plumbing, New York, NY

MODEL NUMBER	PIPE SIZE	LIST PRICE, Each Piece
C1441.5-NH	1 1/2" Cast Iron, Schedule 40 Plastic or Steel	\$3.20
C1442-NH	2" Cast Iron, Schedule 80 Plastic or 1 1/2" Schedule 40 Plastic Hub	\$3.50
C1443-NH	3" Cast Iron, Schedule 40 Plastic, Steel, SDR 35 Plastic, Copper (DWV), Clay	\$4.50
C1444-NH	4" Cast Iron, Schedule 40 Plastic, Steel, SDR 35 Plastic, Copper (DWV), Clay	\$7.15

CROSS REFERENCE

MIFAB	ANACO	FERNCO	HUSKY	MISSION	PASCO
C1441.5-NH	-	-	-	ST-152	4803
C1442-NH	-	-	-	ST-201	4804
C1443-NH	-	-	-	ST-301	4806
C1444-NH	-	-	-	ST-402	4808

MI-EC

END CAPS

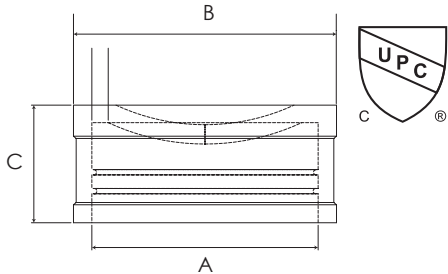

MIFAB's flexible rubber end caps are used to cap pipe ends, cleanouts and open pipes. They are suitable for above ground or underground use on cast iron, steel, PVC or ABS pipes.

Tested and Certified to I.A.P.M.O. Standard PS 90-06. All models are listed with I.A.P.M.O. (U.P.C.) 5/16" driver required to tighten bolts. All models are listed to the National Plumbing Code of Canada and relevant Canadian Standard(s) and bear the cUPC mark of conformity®. All models are manufactured in compliance with IAPMO PS 90-06 and CSA B602-2016. Non constant temperature rating is 140 F.

Stainless Steel Clamp and 5/16" hex head bolt are made from Type 300 Stainless Steel.



MODEL NUMBER	PIPE SIZE	A WIDTH	B WIDTH	C HEIGHT	CARTON QUANTITY	PALLET QUANTITY	LIST PRICE, Each Piece
MI-EC-150	1 1/2"	1.61" (41)	1.95" (50)	1.15" (29)	160	11,520	\$5.00
MI-EC-200	2"	1.94" (49)	2.48" (63)	1.25" (32)	150	10,350	\$5.70
MI-EC-300	3"	3.09" (79)	3.63" (92)	1.39" (35)	100	4,800	\$7.20
MI-EC-400	4"	3.96" (101)	4.60" (117)	1.65" (42)	80	3,200	\$9.50
MI-EC-500	5"	5.03" (128)	5.85" (149)	2.09" (53)	40	-	\$12.40
MI-EC-600	6"	5.73" (146)	6.62" (168)	2.20" (56)	40	-	\$12.70
MI-EC-800	8"	7.70" (196)	8.85" (225)	2.95" (75)	40	-	\$25.75

CROSS REFERENCE

MIFAB	ANACO	FERNCO	HUSKY	MISSION	PASCO
MI-EC-150	9329	QC-101	9329	0701 011	4417
MI-EC-200	9330	QC-102	9330	0702 019	4418
MI-EC-300	9331	QC-103	9331	0703 017	4419
MI-EC-400	9332	QC-104	9332	0704 015	4422
MI-EC-500	-	QC-105	-	0705 020	4840
MI-EC-600	-	QC-106	-	0706 028	4841
MI-EC-800	-	QC-108	-	0708 016	4842

CALIFORNIA PROPOSITION 65 WARNING. This product contains chemicals known to the State of California to cause cancer and birth defects or other reproductive harm.

Design and dimensions are subject to modification. Prices do not include applicable taxes. Visit www.mifab.com for the most recent product information.

MIFAB®, Inc., 1321 West 119th Street, Chicago, Illinois 60643-5109, USA

Toll Free: 1-800-465-2736, Fax: 1-773-341-3049

All sales subject to MIFAB's® Terms and Warranties. Please refer to inside front cover.

sales@mifab.com • Canada Toll Free: 1-800-387-3880

MI-ELB ELBOWS



MIFAB's MI-ELB Series of flexible rubber Elbows are used to connect all common household drain, waste and vent pipes quickly. They are extra long to replace fittings cut out at the joint during alteration or repair.

All models are listed with I.A.P.M.O.

Non constant temperature rating is 140 F.

Stainless Steel Clamps and 5/16" hex head bolts are made from Type 300 Stainless Steel.

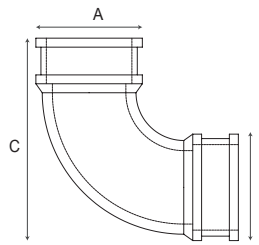

MODEL NUMBER	PIPE SIZE	A WIDTH	B WIDTH	C HEIGHT	CARTON QUANTITY	PALLET QUANTITY	LIST PRICE, Each Piece
MI-ELB-150	1 1/2" Elbow	1.90" (48)	1.90" (48)	4.46" (113)	50	2,700	\$14.30
MI-ELB-200	2" Elbow	2.31" (59)	2.31" (59)	5.17" (131)	20	1,680	\$15.20
MI-ELB-300	3" Elbow	3.44" (87)	3.44" (87)	7.87" (200)	20	560	\$22.60
MI-ELB-400	4" Elbow	4.44" (113)	4.44" (113)	9.63" (245)	6	294	\$33.70

CROSS REFERENCE

MIFAB	ANACO	FERNCO	HUSKY	MISSION	PASCO
MI-ELB-150	-	QL-150	-	M9OL 150	5815
MI-ELB-200	-	QL-200	-	M9OL 200	5822
MI-ELB-300	-	QL-300	-	M9OL 300	5833
MI-ELB-400	-	QL-400	-	M9OL 400	5844

MI-TEE TEES



MIFAB's MI-TEE Series of flexible rubber Tees are used to connect all common household drain, waste and vent pipes quickly. They are extra long to replace fittings cut out at the joint during alteration or repair.

All models are listed with I.A.P.M.O.

Non constant temperature rating is 140 F.

Stainless Steel Clamps and 5/16" hex head bolts are made from Type 300 Stainless Steel.

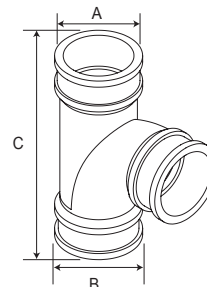

MODEL NUMBER	PIPE SIZE	A WIDTH	B WIDTH	C HEIGHT	CARTON QUANTITY	PALLET QUANTITY	LIST PRICE, Each Piece
MI-ELB-150	1 1/2" Elbow	1.90" (48)	1.90" (48)	4.46" (113)	50	2,700	\$17.90
MI-ELB-200	2" Elbow	2.31" (59)	2.31" (59)	5.17" (131)	20	1,680	\$19.35
MI-ELB-300	3" Elbow	3.44" (87)	3.44" (87)	7.87" (200)	20	560	\$29.60
MI-ELB-400	4" Elbow	4.44" (113)	4.44" (113)	9.63" (245)	6	294	\$41.60

CROSS REFERENCE

MIFAB	ANACO	FERNCO	HUSKY	MISSION	PASCO
MI-TEE-150	-	QT-150	-	MTY 150	5715
MI-TEE-200	-	QT-200	-	MTY 200	5722
MI-TEE-300	-	QT-300	-	MTY 300	5733
MI-TEE-400	-	QT-400	-	MTY 400	5744

CALIFORNIA PROPOSITION 65 WARNING. This product contains chemicals known to the State of California to cause cancer and birth defects or other reproductive harm.

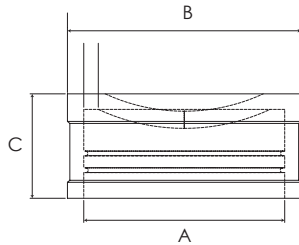
MI-EC-HB
END CAP WITH HOSE BIBB

MIFAB's flexible rubber end caps with hose bibb are used to cap pipe ends, cleanouts and open pipes. They are suitable for above ground or underground use on cast iron, steel, PVC or ABS pipes.

5/16" driver required to tighten bolts to 60 lbs. torque. All models are manufactured in compliance with IAPMO PS 90-06 and CSA B602-2016. Non constant temperature rating is 140 F.

Stainless Steel Clamp and 5/16" hex head bolt are made from Type 300 Stainless Steel.

"MIFAB manufactures a quality coupling, easy to install, and definitely a time saver."

– Forest Powell, General Foreman, Collins Plumbing, San Diego, CA

MODEL NUMBER	PIPE SIZE	A WIDTH	B WIDTH	C HEIGHT	CARTON QUANTITY	LIST PRICE, Each Piece
MI-EC-150-HB	1 1/2"	1.61" (41)	1.95" (50)	1.15" (29)	50	\$58.00
MI-EC-200-HB	2"	1.94" (49)	2.48" (63)	1.25" (32)	50	\$60.00
MI-EC-300-HB	3"	3.09" (79)	3.63" (92)	1.39" (35)	40	\$62.00
MI-EC-400-HB	4"	3.96" (101)	4.60" (117)	1.65" (42)	20	\$64.00
MI-EC-500-HB	5"	5.03" (128)	5.85" (149)	2.09" (53)	10	\$66.00
MI-EC-600-HB	6"	5.73" (146)	6.62" (168)	2.20" (56)	10	\$78.00

CROSS REFERENCE

MIFAB	ANACO	FERNCO	HUSKY	MISSION	PASCO
MI-EC-150-HB	-	HBC-1	-	0701 011	4857HB
MI-EC-200-HB	-	HBC-2	-	0702 514	4858HB
MI-EC-300-HB	-	HBC-3	-	0703 512	4859HB
MI-EC-400-HB	-	HBC-4	-	0704 510	4860HB
MI-EC-500-HB	-	-	-	0705 517	-
MI-EC-600-HB	-	-	-	0706 515	-

CALIFORNIA PROPOSITION 65 WARNING. This product contains chemicals known to the State of California to cause cancer and birth defects or other reproductive harm.

Design and dimensions are subject to modification. Prices do not include applicable taxes. Visit www.mifab.com for the most recent product information.

MIFAB®, Inc., 1321 West 119th Street, Chicago, Illinois 60643-5109, USA

Toll Free: 1-800-465-2736, Fax: 1-773-341-3049

All sales subject to MIFAB'S® Terms and Warranties. Please refer to inside front cover.

sales@mifab.com • Canada Toll Free: 1-800-387-3880

Location: _____



MI-HUB

**SHIELDED
NO HUB COUPLINGS**

Specification: MIFAB® Series MI-HUB (specify size) shielded no hub couplings are manufactured with gaskets made from neoprene that meets the requirements of ASTM C-564 housed inside a Type 301 stainless steel corrugated shield. Two (2" through 4" size), four (6" through 10" size) or six (12" and 15" sizes) Type 301 stainless steel clamps tightened with 5/16" Type 305 stainless steel hex head screws surround the shield to provide the sealing force. MI-HUB Series Couplings are tested and certified to the ASTM-#C1277-2018,, CISPI 310-2010, and CSA B602-2016 (File # 247608) Standards and are listed with IAPMO and NSF certified to CISPI 310. Also tested and certified by Intertek Testing Services to CAN/ULC S102.2-07 "Smoke Test." NSF Certified to the CISPI 310 Standard.

Function: Used to provide a positive and significant seal between no hub cast iron pipe and fittings.

Material Specifications:

Bands - Type 301 AISI stainless steel (Minimum tensile 165,000 psi).

Eyelets - Type 301 AISI stainless steel.

Gasket - Neoprene - meeting the requirements of ASTM C-564.

Screw Housing - Type 304 AISI stainless steel.

Screws - Type 305 AISI stainless steel, 5/16" Hex head / Shoulder.

Shield - Type 301 AISI stainless.



Performance Specifications:

- Tested to maintain 4.3 psi of water pressure (typical 10' head).
- Requires a 5/16" hex head

MODEL NUMBER	PIPE SIZE (NOMINAL DIA.)	(L) LENGTH (COUPLING)	INSTALLATION TORQUE (IN. - LBS)	NUMBER OF CLAMPS PER COUPLING	BAND WIDTH (CLAMP)
MI-HUB-1.5	1 1/2"	2 1/8"	60	2	9/16"
MI-HUB-2x1.5	2 x 1 1/2"	2 1/8"	60	2	9/16"
MI-HUB-2	2"	2 1/8"	60	2	9/16"
MI-HUB-3	3"	2 1/8"	60	2	9/16"
MI-HUB-3x2	3" x 2"	2 1/8"	60	2	9/16"
MI-HUB-4	4"	2 1/8"	60	2	9/16"
MI-HUB-4x2	4" x 2"	2 1/8"	60	2	9/16"
MI-HUB-4x3	4" x 3"	2 1/8"	60	2	9/16"
MI-HUB-5	5"	3"	60	4	9/16"
MI-HUB-6	6"	3"	60	4	9/16"
MI-HUB-8	8"	4"	60	4	9/16"
MI-HUB-10	10"	4"	60	4	9/16"
MI-HUB-12	12"	5.43"	60	6	9/16"
MI-HUB-15	15"	5.43"	60	6	9/16"

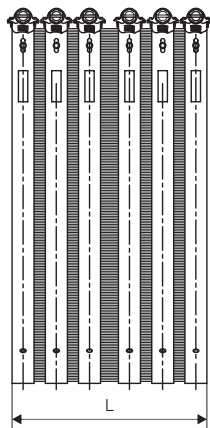

12", 15" Sizes
Tighten inside bands first, then outside bands.

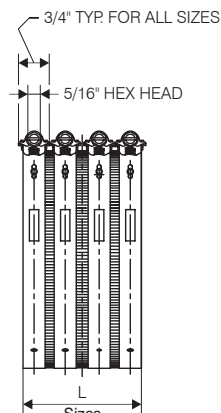

Sizes 5" through 10"
Tighten inside bands first, then outside bands.

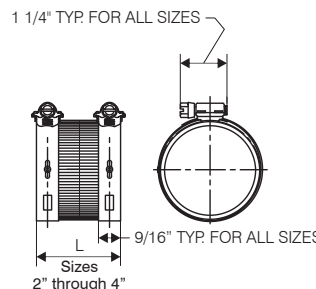

Sizes 2" through 4"
Tighten bands alternately to recommended torque.



CALIFORNIA PROPOSITION 65 WARNING. This product contains chemicals known to the State of California to cause cancer and birth defects or other reproductive harm.

MIFAB MI-HUB NO HUB COUPLINGS FEATURES AND BENEFITS

1) Stainless Steel Shield

A corrugated stainless steel shield provides a solid surface for the bands to tighten against to ensure a uniform grip around the pipe / fittings.

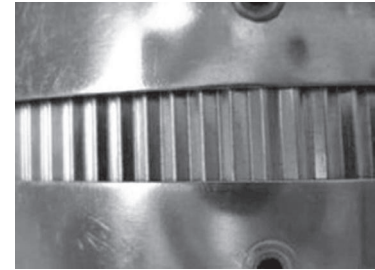

2) Mechanical Interlocking Clamp Design

A one piece stainless steel screw housing mechanically interlocks the housing to the stainless steel band. This one piece housing eliminates leak paths than can develop with welded or staked clamps.



3) Floating Eyelet Design

The stainless steel clamp bands can move independently from the corrugated stainless steel shield. This independence prevents the shield from crimping during tightening which can lead to leaks.

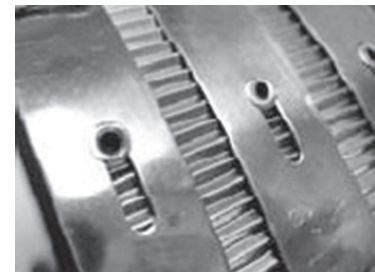

“We brought Mifab couplings into our inventory and have been very happy with them. Great Price Point, and readily available.”

– John Kozel, WinSupply, Ontario, CA

4) 5/16” Hex Head Screw

The stainless steel 5/16” hex head screw is engineered to accept 60-inch pounds of installation torque to ensure a secure band / shield assembly around the pipe / fittings.



5) Formed Gasket Design

The gasket is designed to form fit around the pipe and the inside of the shield so that when the clamping forces are applied, a superior sealing pressure and holding power is achieved. MIFAB’s gaskets are made from neoprene which meets the requirements of ASTM C564.

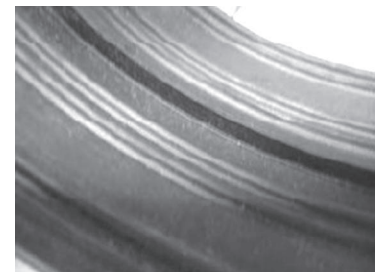

6) Approvals

MIFAB’s MI-HUB Series of no hub couplings are tested and certified to the following Standards:

ASTM C-564, ASTM #C1277-2018, CISPI 310-2010, CSA B602-2016 and CAN/ULC S102.2-07 “Smoke Test.”

They are also listed with I.A.P.M.O.

They are NSF Certified to the CISPI 310 Standard.

CALIFORNIA PROPOSITION 65 WARNING. This product contains chemicals known to the State of California to cause cancer and birth defects or other reproductive harm.

Design and dimensions are subject to modification. Prices do not include applicable taxes. Visit www.mifab.com for the most recent product information.

MIFAB®, Inc., 1321 West 119th Street, Chicago, Illinois 60643-5109, USA

All sales subject to MIFAB’s® Terms and Warranties. Please refer to inside front cover.

Toll Free: 1-800-465-2736, Fax: 1-773-341-3049
sales@mifab.com • Canada Toll Free: 1-800-387-3880

MIFAB NO HUB COUPLINGS INSTALLATION INSTRUCTIONS

The following installation instructions provide guidelines for joining MIFAB's MI-HUB Series of shielded no hub couplings to no hub pipe and fittings in accordance with standard industry practice.

Note that each City, State, Province or Region may have governing codes, engineering requirements and local practices of the plumbing trade that must be followed.

A correctly calibrated torque wrench set at 60-inch pounds should always be used when installing MIFAB's no hub couplings. If power tools are used, they should be calibrated to torque only to 60-inch pounds.

- 1) Ensure that the pipe ends are cut square.
- 2) Place the neoprene gasket onto the end of one piece of pipe / fitting and the stainless steel clamp assembly over the other piece of pipe / fitting to be joined.
- 3) Place the second piece of pipe end into gasket, firmly placing both ends against the rib or shoulder in the center of the gasket.
- 4) Ensure that the pipe / fittings to be joined are aligned, then slide the loose coupling over the gasket so that the gasket is completely covered.
- 5) For MIFAB's 2", 3" and 4" no hub couplings with two sealing bands, use a torque wrench to tighten the stainless steel screws alternately to 60 inch pounds torque.

MIFAB's 5", 6", 8", and 10" no hub couplings have four sealing bands. Tighten the bands to 60-inch pounds torque in the following sequence: Start on the side of the joint with the smaller diameter (see detail A) and torque as follows:

2,1 - 2,1 - 3,4 - 3,4 - 2,1 - 3,4

MIFAB's 12" no hub couplings have six sealing bands. Tighten the bands to 60-inch pounds torque in the following sequence: Start on the side of the joint with the smaller diameter (see detail B) and torque as follows:

3,2,1 - 3,2,1 - 4,5,6 - 4,5,6 - 3,2,1 - 4,5,6

The large side and small size refer to if a fitting is being used with a straight pipe. Typically the fitting has a larger diameter compared to straight pipe.

"Our largest multi-family contractors have had huge success with the MI-HUB NSF approved standard no hub couplings. We now have multiple wholesalers buying direct containers and the success has anchored us closer to these massive contractors."

The MI-HUB NSF couplings are being installed in volume in the City of Oakland. Oakland has the toughest municipal addendum to the California State Plumbing Code to prohibit cheap import untested couplings. We have earned their support through quality manufacturing and NSF compliance testing.

MIFAB's MI-XHUB couplings have been tested to the tough FM-1680 Standard. These couplings go in clean, fast and without any issues."

– Corey Kliman, owner, Kliman Sales, San Jose, CA

"Pricing is competitive with local stock."

– Action Plumbing Supply, Florida

5" thru 10"

small side large side

1 2 3 4

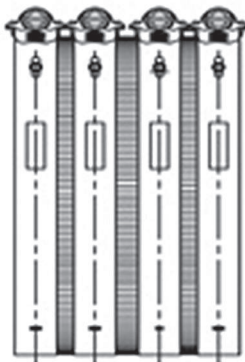

DETAIL A

12" SIZE

small side large side

1 2 3 4 5 6

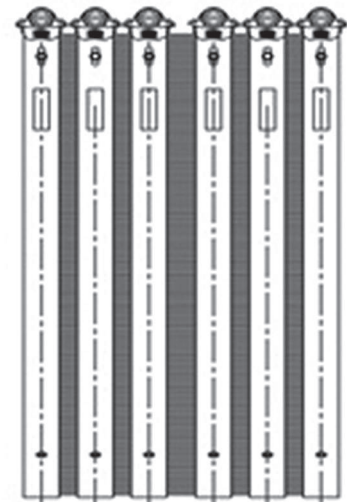

DETAIL B

CALIFORNIA PROPOSITION 65 WARNING. This product contains chemicals known to the State of California to cause cancer and birth defects or other reproductive harm.

IAPMO RESEARCH AND TESTING, INC.

5001 East Philadelphia Street, Ontario, California 91761-2816 • (909) 472-4100 Fax (909) 472-4244 • www.iapmo.org



CERTIFICATE OF LISTING



IAPMO Research and Testing, Inc. is a product certification body which tests and inspects samples taken from the supplier's stock or from the market or a combination of both to verify compliance to the requirements of applicable codes and standards. This activity is coupled with periodic surveillance of the supplier's factory and warehouses as well as the assessment of the supplier's Quality Assurance System. This listing is subject to the conditions set forth in the characteristics below and is not to be construed as any recommendation, assurance or guarantee by IAPMO Research and Testing, Inc. of the product acceptance by Authorities Having Jurisdiction.

This certificate is not evidence of current listing. To verify listing status, visit the IAPMO R&T Product Listing Directory at pld.iapmo.org

Effective Date: June 2019
 Product: Hubless Cast Iron Pipe Couplings
 Issued To: Mifab, Inc.
 1321 West 119th Street
 Chicago, IL 60643

Void After: June 2024
 File No. 5226

Identification: Gasket shall be marked with raised letters with pipe size, country of origin, manufacturer's name or trademark, "C564", and "CSA B602" with latest revision. The band of coupling shall be marked with the pipe size. The screw housing shall be marked with manufacturer's name or trademark, country of origin and the words "ALL STAINLESS" or "ALL SS". The coupling assembly shall also be permanently marked with the pipe material for which the coupling is designed. The gasket and bands shall also bear the cUPC® certification mark.

Characteristics: An elastomeric coupling and 300 series stainless steel shield & bands for use in joining hubless cast iron soil pipe and fittings in drainage, waste and vent systems. To be installed with IAPMO listed pipe and fittings and in accordance with the manufacturer's instructions and the requirements of the latest edition of the Uniform Plumbing Code.

Products listed on this certificate have been tested by an IAPMO R&T recognized laboratory. This recognition has been granted based upon the laboratory's compliance to the applicable requirements of ISO/IEC 17025.

Products are in compliance with the following code(s):

- Uniform Plumbing Code (UPC®)
- National Plumbing Code of Canada
- International Plumbing Code (IPC®)

Products are in compliance with the following standard(s):

ASTM C1277-2018 (excluding Annex A1) and CSA B602-2016.

- | | |
|------------|-------------|
| MI-HUB-1.5 | MI-HUB-6 |
| MI-HUB-10 | MI-HUB-8 |
| MI-HUB-12 | MI-QHUB-150 |
| MI-HUB-15 | MI-QHUB-2 |
| MI-HUB-2 | MI-QHUB-3 |
| MI-HUB-3 | MI-QHUB-4 |
| MI-HUB-3X2 | MI-QHUB-5 |
| MI-HUB-4 | MI-QHUB-6 |
| MI-HUB-4X3 | MI-QHUB-8 |
| MI-HUB-5 | |

 Chairman, Product Certification Committee

 CEO, The IAPMO Group



This listing period is based upon the last date of the month indicated on the Effective Date and Void After Date shown above. Any change in material, manufacturing process, marking or design without having first obtained the approval of the Product Certification Committee, or any evidence of non-compliance with applicable codes and standards or of inferior workmanship, may be deemed sufficient cause for revocation of this listing. Production or reference to this form for advertising purposes may be made only by specific written permission of IAPMO Research and Testing, Inc. Any alteration of this certificate could be grounds for revocation of the listing. This document shall be reproduced in its entirety.

CALIFORNIA PROPOSITION 65 WARNING. This product contains chemicals known to the State of California to cause cancer and birth defects or other reproductive harm.

Design and dimensions are subject to modification. Prices do not include applicable taxes. Visit www.mifab.com for the most recent product information.

MIFAB®, Inc., 1321 West 119th Street, Chicago, Illinois 60643-5109, USA
 All sales subject to MIFAB's® Terms and Warranties. Please refer to inside front cover.

Toll Free: 1-800-465-2736, Fax: 1-773-341-3049
 sales@mifab.com • Canada Toll Free: 1-800-387-3880



CSA INTERNATIONAL

Certificate of Compliance

Certificate: 2199383

Master Contract: 247608

Project: 2199383

Date Issued: November 17, 2011

MIFAB, Inc.
1321 West 119th St
Chicago, IL 60643
USA

Attention: Mr. Mike Whiteside

The products listed below are eligible to bear the CSA Mark shown

Issued by: Kelly Yaremko

PRODUCTS

CLASS – 7021 01 PIPE AND PIPE FITTINGS Mechanical Joints (Non-Transition Type)

CLASS – 7021 02 PIPE AND PIPE FITTINGS Mechanical Coupling

Mechanical Joint (MJ) couplings, for use with plain-end cast iron soil pipe and pipe fittings: Same size pipe fittings; 1-1/2, 2, 3, 4, 5, 6, 8, 10 inch. Reduced size pipe fittings; 2 x 1-1/2, 3 x 2, 4 x 3, 4 x 2 inch.

APPLICABLE REQUIREMENTS

CSA Standard CSA-B70-02 Cast Iron Soil Pipe, Fittings and Means of Joining

CSA Standard CSA-B602-05 Mechanical Couplings for Drain, Waste, and Vent Pipe and Sewer Pipe

MARKINGS

Submittor's name and/or CSA file number 247608, model designation and the CSA Mark appear in a permanent manner on each unit.



Supplement to Certificate of Compliance

Certificate: 2199383

Master Contract: 247608

The products listed, including the latest revision described below, are eligible to be marked in accordance with the referenced Certificate.

Product Certification History

Project	Date	Description
2475972	Nov 17, 2011	Update report to update Applicable Requirements
2199383	Aug 6, 2009	Original Certification.

Listee
MIFAB
247608

- MI-HUB-150
- MI-HUB-2
- MI-HUB-3
- MI-HUB-4
- MI-HUB-5
- MI-HUB-6
- MI-HUB-8
- MI-HUB-10
- MI-HUB-2150
- MI-HUB-32
- MI-HUB-43
- MI-HUB-42

“MIFAB’s transition couplings are a great quality product for the money plus having a local rep’s stock almost in our backyard makes it easy to pick up the One Off odd balls.”

– Allan Pollock, REX Pipe & Supply, Lorain, Ohio

Location: _____



MI-XHUB

HEAVY DUTY SHIELDED NO HUB COUPLINGS

Specification: MIFAB® Series MI-XHUB (specify size) heavy duty shielded no hub couplings are manufactured with gaskets made from neoprene that meets the requirements of ASTM C-564 housed inside a Type 304 stainless steel corrugated shield. Four (2" through 4" size), six (5" through 15" size) Type 304 stainless steel clamps tightened with 3/8" Type 305 stainless steel hex head screws surround the shield to provide the sealing force. MI- XHUB Series Couplings are tested and certified to the ASTM-C1540-2015 and CSA B602-2016 Standards and are listed with IAPMO. The MI-XHUB are also tested and certified by Intertek Testing Services to the CAN/ULC S102.2-10 "Smoke Test". The MI-XHUB are tested by I.A.P.M.O. to comply to the FM 1680-1989 Standard (except for markings).

Function: Used to provide a positive and significant seal between no hub cast iron pipe and fittings.



Material Specifications:

Bands - Type 304 AISI stainless steel (Minimum tensile 165,000 psi). **Eyelets** - Type 304 AISI stainless steel.

Gasket - Neoprene - meeting the requirements of ASTM C-564. **Screw Housing** - Type 304 AISI stainless steel.

Eyelets - Type 304 AISI stainless steel.

Screws - Type 305 AISI stainless steel, 3/8" Hex head / Shoulder.

Shield - Type 304 AISI stainless steel painted red for easy identification.

MODEL NUMBER	PIPE SIZE (NOMINAL DIA.)	(L) LENGTH (COUPLING)	INSTALLATION TORQUE (IN. - LBS)	NUMBER OF CLAMPS PER COUPLING	(W) BAND WIDTH (CLAMP)
MI-XHUB-1.5	1 1/2"	3"	80 - 100	4	9/16"
MI-XHUB-2	2"	3"	80 - 100	4	9/16"
MI-XHUB-3	3"	3"	80 - 100	4	29/64"
MI-XHUB-3x2	3" x 2"	3"	80 - 100	4	29/64"
MI-XHUB-4	4"	3"	80 - 100	4	9/16"
MI-XHUB-4x2	4" x 2"	3"	80 - 100	4	9/16"
MI-XHUB-4x3	4" x 3"	3"	80 - 100	4	9/16"
MI-XHUB-5	5"	4"	80 - 100	6	9/16"
MI-XHUB-6	6"	4"	80 - 100	6	9/16"
MI-XHUB-8	8"	4"	80 - 100	6	9/16"
MI-XHUB-10	10"	4"	80 - 100	6	9/16"
MI-XHUB-12	12"	5.43"	80 - 100	6	5/8"
MI-XHUB-15	15"	5.43"	80 - 100	6	5/8"

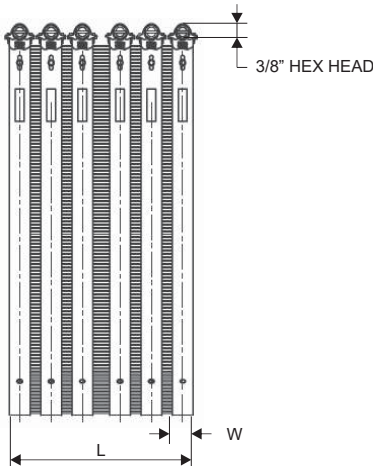

Sizes 5" through 15"
Tighten inside bands first,
then outside bands.

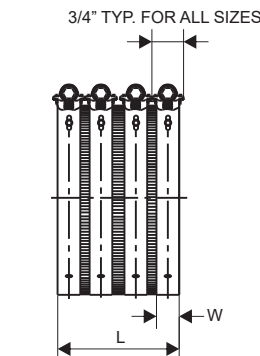

Sizes 2" through 4"
Tighten inside bands first, then
outside bands.

1 7/16" TYP. FOR ALL SIZES

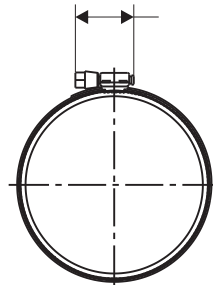

CALIFORNIA PROPOSITION 65 WARNING. This product contains chemicals known to the State of California to cause cancer and birth defects or other reproductive harm.

MIFAB MI-XHUB NO HUB COUPLINGS FEATURES AND BENEFITS

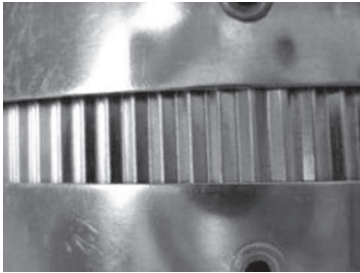

1) Red Shield

A distinctive red stainless steel shield easily identifies MIFAB's heavy duty MI-XHUB no hub couplings.



2) Mechanical Interlocking Clamp Design

A one piece stainless steel screw housing mechanically interlocks the housing to the stainless steel band. This one piece housing eliminates leak paths that can develop with welded or staked clamps.



3) Floating Eyelet Design

The stainless steel clamp bands can move independently from the corrugated stainless steel shield. This independence prevents the shield from crimping during tightening which can lead to leaks.

"I don't even have to think about it. I consider MIFAB to be our partner, not merely our vendor."

– Tom Babcock, Kast Marketing, Chicago, IL



4) 3/8" Hex Head Screw

The stainless steel 3/8" hex head screw is engineered to accept 80-inch pounds of installation torque to ensure a secure band / shield assembly around the pipe / fittings.

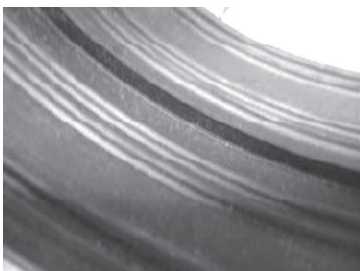

5) Formed Gasket Design

The gasket is designed to form fit around the pipe and the inside of the shield so that when the clamping forces are applied, a superior sealing pressure and holding power is achieved. MIFAB's gaskets are made from neoprene which meets the requirements of ASTM C564.

6) Approvals

MIFAB's MI-XHUB Series of no hub couplings are tested and certified to the following Standards: ASTM C-564, ASTM C1540-2015 and CSA B602-2016 and are also listed with I.A.P.M.O. The MI-XHUB are also tested and certified by Intertek Testing Services to the CAN/ULC S102.2-10 "Smoke Test". The MI-XHUB are tested by I.A.P.M.O. to comply to the FM 1680-1989 Standard (except for markings).

CALIFORNIA PROPOSITION 65 WARNING. This product contains chemicals known to the State of California to cause cancer and birth defects or other reproductive harm.

Design and dimensions are subject to modification. Prices do not include applicable taxes. Visit www.mifab.com for the most recent product information.

MIFAB®, Inc., 1321 West 119th Street, Chicago, Illinois 60643-5109, USA

All sales subject to MIFAB's® Terms and Warranties. Please refer to inside front cover.

Toll Free: 1-800-465-2736, Fax: 1-773-341-3049
sales@mifab.com • Canada Toll Free: 1-800-387-3880

MIFAB XHUB COUPLINGS INSTALLATION INSTRUCTIONS

The following installation instructions provide guidelines for joining MIFAB's MI-XHUB Series of shielded no hub couplings to no hub pipe and fittings in accordance with standard industry practice.

Note that each City, State, Province or Region may have governing codes, engineering requirements and local practices of the plumbing trade that must be followed.

A correctly calibrated torque wrench set at 80-inch pounds should always be used when installing MIFAB's no hub couplings. If power tools are used, they should be calibrated to torque only to 80-inch pounds.

- 1) Ensure that the pipe ends are cut square.
- 2) Place the neoprene gasket onto the end of one piece of pipe / fitting and the stainless steel clamp assembly over the other piece of pipe / fitting to be joined.
- 3) Place the second piece of pipe end into gasket, firmly placing both ends against the rib or shoulder in the center of the gasket.
- 4) Ensure that the pipe / fittings to be joined are aligned, then slide the loose coupling over the gasket so that the gasket is completely covered.
- 5) For MIFAB's 2", 3" and 4" no hub couplings with four sealing bands, use a torque wrench to tighten the bands to 80-inch pounds torque in the following sequence:

Start on the side of the joint with the smaller diameter (see detail A) and torque as follows:

2,1 - 2,1 - 3,4 - 3,4 - 2,1 - 3,4

MIFAB's 5", 6", 8", 10" and 12" no hub couplings have six sealing bands. Tighten the bands to 80-inch pounds torque in the following sequence: Start on the side of the joint with the smaller diameter (see detail B) and torque as follows:

3,2,1 - 3,2,1 - 4,5,6 - 4,5,6 - 3,2,1 - 4,5,6

The large side and small size refer to if a fitting is being used with a straight pipe. Typically the fitting has a larger diameter compared to straight pipe.

"My favorite thing about MIFAB is the great people. They are wonderful starting with the Owner, the Sales Managers and right on down the line."
 → Dan Thomas, Ben Thomas and Associates,
 Shade Gap, PA

2" thru 4"

small side large side

1 2 3 4

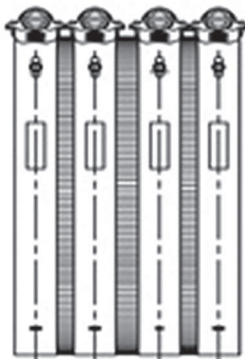

DETAIL A

5" thru 10"

small side large side

1 2 3 4 5 6

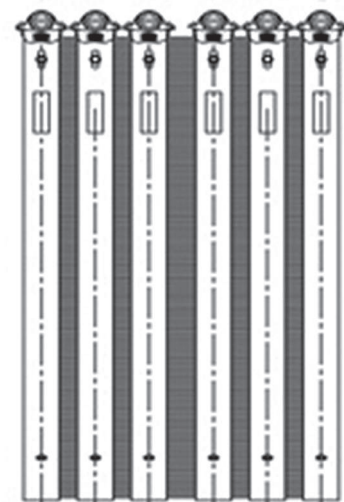

DETAIL B

CALIFORNIA PROPOSITION 65 WARNING. This product contains chemicals known to the State of California to cause cancer and birth defects or other reproductive harm.

IAPMO RESEARCH AND TESTING, INC.

5001 East Philadelphia Street, Ontario, California 91761-2816 • (909) 472-4100 Fax (909) 472-4244 • www.iapmo.org



CERTIFICATE OF LISTING



IAPMO Research and Testing, Inc. is a product certification body which tests and inspects samples taken from the supplier's stock or from the market or a combination of both to verify compliance to the requirements of applicable codes and standards. This activity is coupled with periodic surveillance of the supplier's factory and warehouses as well as the assessment of the supplier's Quality Assurance System. This listing is subject to the conditions set forth in the characteristics below and is not to be construed as any recommendation, assurance or guarantee by IAPMO Research and Testing, Inc. of the product acceptance by Authorities Having Jurisdiction.

This certificate is not evidence of current listing. To verify listing status, visit the IAPMO R&T Product Listing Directory at pld.iapmo.org

Effective Date: June 2019 Void After: June 2024
Product: Heavy Duty Shielded Couplings Joining File No. 5225
Hubless Cast Iron Soil Pipe and Fittings

Issued To: Mifab, Inc.
1321 West 119th Street
Chicago, IL 60643

Identification: Each clamp assembly shall be permanently marked with the manufacturer's name or U.S. registered trademark, the country of origin, "all stainless" and the pipe size for which it is designed. Gaskets shall be marked with the manufacturer's name or symbol, the pipe size and material and class (such as NH, SV, XH), the year of manufacture, country of origin and the ASTM specification designation. Each major component shall be permanently marked with "CSA B602". The product shall also bear the cUPC® certification mark.

Characteristics: Heavy Duty Shielded Couplings to be installed in accordance with the manufacturer's instructions and the latest edition of the Uniform Plumbing Code.

Products listed on this certificate have been tested by an IAPMO R&T recognized laboratory. This recognition has been granted based upon the laboratory's compliance to the applicable requirements of ISO/IEC 17025.

Products are in compliance with the following code(s):
Uniform Plumbing Code (UPC®)
National Plumbing Code of Canada
International Plumbing Code (IPC®)

Products are in compliance with the following standard(s):
ASTM C1540-2015 (excluding Annex A1) and CSA B602-2016

- MODELS:
- MI-XHUB-2
- MI-XHUB-3
- MI-XHUB-4
- MI-XHUB-5
- MI-XHUB-6
- MI-XHUB-8
- MI-XHUB-10
- MI-XHUB-12
- MI-XHUB-1.5
- MI-XHUB-3X2
- MI-XHUB-4X3
- MI-XHUB-15

Chairman, Product Certification Committee

CEO, The IAPMO Group



This listing period is based upon the last date of the month indicated on the Effective Date and Void After Date shown above. Any change in material, manufacturing process, marking or design without having first obtained the approval of the Product Certification Committee, or any evidence of non-compliance with applicable codes and standards or of inferior workmanship, may be deemed sufficient cause for revocation of this listing. Production of or reference to this form for advertising purposes may be made only by specific written permission of IAPMO Research and Testing, Inc. Any alteration of this certificate could be grounds for revocation of the listing. This document shall be reproduced in its entirety.

CALIFORNIA PROPOSITION 65 WARNING. This product contains chemicals known to the State of California to cause cancer and birth defects or other reproductive harm.

Design and dimensions are subject to modification. Prices do not include applicable taxes. Visit www.mifab.com for the most recent product information.

MIFAB®, Inc., 1321 West 119th Street, Chicago, Illinois 60643-5109, USA
All sales subject to MIFAB's® Terms and Warranties. Please refer to inside front cover.

Toll Free: 1-800-465-2736, Fax: 1-773-341-3049
sales@mifab.com • Canada Toll Free: 1-800-387-3880

TEST REPORT



Ph: 909.472.4100 • Fax 909.472.4243 • Web: www.iapmo.org
5001 East Philadelphia Street • Ontario, California 91761-2816 - USA

Report Number: 321-11031 Project No.: 18826
Report Issued: June 8, 2011
Client: Mifab
1321 West 119th street
Chicago, IL 60643
Contact: Michael Whiteside
Source of Samples: The samples were shipped by the manufacturer, and received by IAPMO R&T Lab in good condition on March 31, 2011.
Date of Testing: April 08, 2011 to June 8, 2011
Sample Description: Heavy Duty Hubless Couplings
Model nos: MI-XHUB-150, MI-XHUB-2, MI-XHUB-3, MI-XHUB- 4", MI-XHUB-5, MI-XHUB-6, MI-XHUB-8 and MI-XHUB-10.

Each unit consisted of a rubber gasket, a corrugated stainless steel shield, and stainless steel bands / clamp assembly.

Scope of Testing: The purpose of the testing was to determine if the samples tested of the hubless couplings met the applicable requirements of FM 1680-1989, entitled "Approval Standard for Couplings Used in Hubless Cast Iron Systems for Drain, Waste or Vent, Sewer, Rainwater or Storm Drain Systems Above and Below Ground, Industrial/Commercial and Residential".

Conclusion: The samples tested of the heavy duty hubless couplings models shown above, from Mifab, complied with all the applicable requirements of FM 1680-1989, Except for 4.1 Markings.

By our signatures below, we certify that all the testing and sample preparation for this report was performed under continuous, direct supervision of IAPMO R&T Lab, unless otherwise noted.

Tested by:

Reviewed by:



Hanks Ninh, Project Engineer

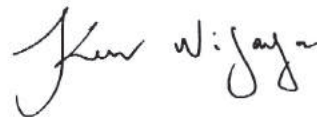

Ken Wijaya, Sr. Laboratory Director

REGULAR DUTY (MI-HUB) VS. HEAVY DUTY (MI-XHUB NO HUB COUPLINGS)

MIFAB's Series of MI-HUB and MI-XHUB no hub couplings are designed and engineered to connect cast iron pipe and fittings together. MIFAB's flexible stainless steel shield provides adjustability to the installing contractor when working with cast iron pipe and fittings that are over or undersized to ensure a quality system and labor savings.

MIFAB's MI-HUB Series is a "regular duty" no hub coupling tested and certified to the ASTM # #C1277-2018, ASTM C564, CISPI 310-2010 and CSA B602-2016 Standards and are listed with IAPMO and NSF certified to CISPI 310. They are also tested by Intertek Testing Services to CAN / ULC S102.2-07 "smoke test".

Storm and Sanitary drainage systems are generally considered to be "low pressure" systems under normal conditions. This changes when a blockage in the line occurs and the resulting build up of water can greatly increase the pressure within the system.

High pressures can also occur in plumbing systems when lower level parking garages and multistory lobbies are built. Often, the design of these structures does not allow for relief in the sanitary systems for four floors or more. The condition known as "Hydraulic Jump" can lead to surges and pressure at any change of direction; especially at the base of the stack. Storm systems have even a greater risk of high line pressure occurrences since they are often not relieved for the total height of the structure.

Underground piping systems have different issues and risks not found above ground. Movement of the earth during back filling and settling of trench beddings is common. In addition, areas of seismic activity, unstable soil conditions caused by thermal effects (expansion and contraction), environments of high corrosion and high groundwater tables can lead to separation of joints without visibility to the installer.

Failure of the piping system due to high line pressures and faulty underground installations can lead to pipes leaking /breaking at their joints. The resulting water leaks can cause damage within the building, affecting equipment, furniture, machinery and the building structure. Plumbing Engineers should consider specifying MIFAB's "heavy duty" no hub couplings to minimize these risks.

MIFAB's MI-XHUB Series is a "heavy duty" no hub coupling tested and certified to the ASTM # C1540-2011, ASTM C564 and CSA B602-2016 Standards and listed with IAPMO. The MI-XHUB Series has also been tested by IAPMO to the FM1680-1989 Standard (except for markings).

The MI-XHUB Series provides a more rigid joint connection than the MI-HUB Series because it has a wider shield and a greater number of stainless steel clamps. These additional clamps, which need to be torqued to 80/100 inch pounds, make a more uniformly rigid joint with the load supported at the outer edges of the coupling and the centerline of the joint. The additional clamps also increase the surface bearing contact between the coupling and the pipe / fittings to reduce joint movement at high internal line pressures. In comparison, the industry's "regular duty" no hub couplings have two fewer clamps and are torqued only to 60 inch pounds.

MIFAB's MI-XHUB Series of heavy duty no hub couplings is the specifier's ideal choice for the most demanding conditions.

"I feel comfortable calling MIFAB to ask for advice and assistance."

– Joe Ficek, Grumman Butkus Consulting Engineers, Chicago, IL

REQUIRED USE OF HANGERS AND SUPPORTS

To ensure optimum performance of a no hub cast iron pipe and fittings connected with MIFAB's no hub couplings, please consider the following:

1. UNDERGROUND INSTALLATIONS:

No hub cast iron pipe in trenches should be continuously supported on undisturbed earth, compacted fill or on masonry blocks at each joint connection. The line and grade of the pipe must be correct. Each vertical unsupported branch of pipe must be securely staked in order to maintain stability during backfilling and pouring of concrete. The pipe should be stabilized in the correct position by partial backfilling and cradling to ensure the proper alignment during backfilling. Ensure that large rocks and / or other large objects are not dropped into the trench on top of the piping system.

2. VERTICAL PIPE INSTALLATIONS:

No hub cast iron pipe and fittings installed vertically should be secured with floor clamps at each stack base and at each story height or at intervals close enough to maintain system alignment.

3. HORIZONTAL PIPE INSTALLATIONS:

No hub cast iron pipe and fittings installed horizontally should have pipe hangers installed per the local plumbing code to ensure proper alignment and grade to prevent shear. Horizontal piping should be supported at five foot intervals except that pipe exceeding five feet in length may be supported at ten foot intervals. Hangers should be installed at each horizontal branch connection. Hangers and supports should be installed within 18" of the no hub coupling. The bases of cast iron stacks should be supported on concrete, on brick laid in cement, by metal brackets attached to the building or by local plumbing code approved installations. Large diameter pipe (six inches and larger) should be braced at changes of direction to prevent horizontal movement.

Closet bends, traparms, traps and other branches should be securely supported by a clevis type hanger, strapping or cradled underneath by earth and secured above by a suitable material to provide a firm contact between the pipe and the building in order to prevent movement in any direction and to ensure the stability of the piping system.

Note: All pipe connections should be made and supported in accordance to local plumbing codes.

CALIFORNIA PROPOSITION 65 WARNING. This product contains chemicals known to the State of California to cause cancer and birth defects or other reproductive harm.

Design and dimensions are subject to modification. Prices do not include applicable taxes. Visit www.mifab.com for the most recent product information.

MIFAB®, Inc., 1321 West 119th Street, Chicago, Illinois 60643-5109, USA
All sales subject to MIFAB's® Terms and Warranties. Please refer to inside front cover.

Toll Free: 1-800-465-2736, Fax: 1-773-341-3049
sales@mifab.com • Canada Toll Free: 1-800-387-3880

MI-TORQUE TORQUE WRENCH 60 IN. - LBS.

SPECIFICATION: MIFAB® MI-TORQUE black handled 60 in. – lbs. steel torque wrench with 5/16” hex drive.

FUNCTION: The MI-TORQUE wrench is used to tighten MIFAB’s MI-HUB Series of regular duty no hub couplings and any other brand of regular duty no hub couplings to 60 in. - lbs. in order to connect No-Hub soil pipe. The MI-TORQUE wrench tightens with a ratchet action and slips at the 60 in. - lbs. preset torque limit to avoid over tightening. The T-shaped handle provides good leverage for the operator and fast and easy one - handed tightening in the right hand direction.



MI-TORQUE

MI-TORQUE - List Price - \$50.00

CROSS REFERENCE

MIFAB	Wheeler Rex	Ideal	Lowell	Ridgid
MI-TORQUE	1967	8-9995	3T000	902

“MIFAB commercial plumbing products have you covered so nothing you need slips through your hands.”

– Richard Aliff, BNK Engineering, Raleigh, NC

TESTING AND INSPECTION OF NO HUB COUPLINGS

It is important to test all cast iron piping installations for leaks after the roughing in has been completed. Before testing, the installer should notify the inspector of the local administrative authority having jurisdiction over plumbing installations. Leave concealed work uncovered until the required tests are performed and the system receives approval.

Note: In all installations, installers should be aware of local conditions, codes and regulations. Comply with all local codes, regulations, manufacturers’ instructions and architect engineer specifications.

WATER OR HYDROSTATIC TESTING

This is the most common type of test used to test a completed cast iron soil pipe installation, and it is the test most often recommended by plumbing codes. Its purpose is to check the installation for leaks and to correct these prior to putting the system into service. Use the following steps to perform a water test: (Note: MIFAB does not recommend an air test)

1. Since visual inspection of the system is required, conduct this test prior to enclosing above ground installations, or backfilling below-ground installations.
2. Isolate each floor or section being tested by inserting plugs into the test tees in the stacks.
3. Plug or cap all other openings with test plugs or test caps.
4. Fill the system with water at its highest point. Do this slowly to allow any trapped air to escape as the water level rises. Note: Failure to remove entrapped air may cause faulty test results, so be sure all entrapped air has been removed to obtain reliable test results.
5. As water fills a vertical pipe, it creates hydrostatic pressure. This pressure increases as the height of the water in the vertical pipe increases. MIFAB® recommends water testing with ten feet of hydrostatic pressure (4.3 pounds per square inch).
6. After filling the stack to ten feet of head, visually inspect the section you are testing for any leaks around its joints with: the no hub couplings.
7. In hub less systems, leaks can often be traced to no hub couplings that were not tightened properly to the recommended torque and / or with the correct tools such as a calibrated torque wrench. In these cases, correctly tightening the couplings should eliminate the leak.
8. Water test each portion of the system for 15 minutes. This is sufficient time for any problems to be detected.
9. After a successful test, drain the system and prepare the next section for testing.

CALIFORNIA PROPOSITION 65 WARNING. This product contains chemicals known to the State of California to cause cancer and birth defects or other reproductive harm.

MIFAB® BINDER AND PRICE BOOKS



COMPLETE MIFAB BINDER
(with all product booklets inside)
Lit # 001B



MPB-2019-USA
Lit # 067



NH-2019
Lit # 044



CLPB-2019
Lit # 048



BEECO-2019-07
Lit # 071



AD-2017-USA
Lit # 043



TSP-2017
Lit # 062



TD-2017
Lit # 046



TDSS-2016
Lit # 072

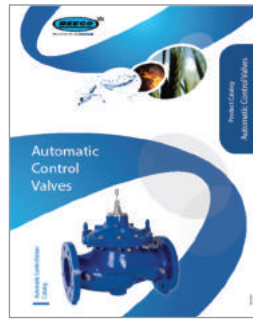

ACV
Lit # 059



DB-2018
Lit # 070



CPORT-2019
Lit # 047



INT-2019
Lit # 095



HYDROMAX-2019
Lit # 082



FILCOTEN-2017
Lit # 076



ROOFGUARD-2018
Lit # 058

CALIFORNIA PROPOSITION 65 WARNING. This product contains chemicals known to the State of California to cause cancer and birth defects or other reproductive harm.

Design and dimensions are subject to modification. Prices do not include applicable taxes. Visit www.mifab.com for the most recent product information.

MIFAB®, Inc., 1321 West 119th Street, Chicago, Illinois 60643-5109, USA
All sales subject to MIFAB'S® Terms and Warranties. Please refer to inside front cover.

Toll Free: 1-800-465-2736, Fax: 1-773-341-3049
sales@mifab.com • Canada Toll Free: 1-800-387-3880

"We have used MIFAB no hub couplings for years without any issues and will continue to use them going forward."

- Frank Ferrara, Owner, Marli Mechanical, Woodbridge, Ontario, Canada

NH-2019



Use the QR Code to download a digital copy of this catalog to your mobile device.

Couplings
LIT-044