

T2000-F 8" Internal Width, Frame

Specification:

MIFAB® Series T2000-F, 8" internal width 1" X 5/8" – 1/8" thick, angle iron frame with acid resistant powder epoxy coating and 1" X 3" anchor tabs. Frames can accommodate all ClipFix self locking grates. Note: Must order in 20" long increments. 10' long sections are standard.

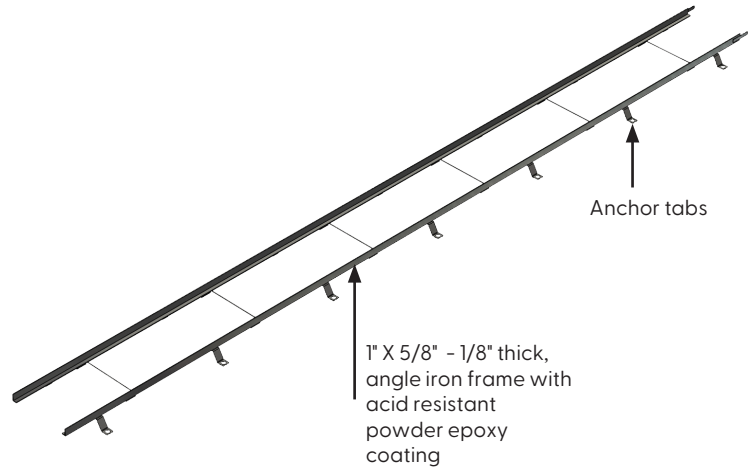
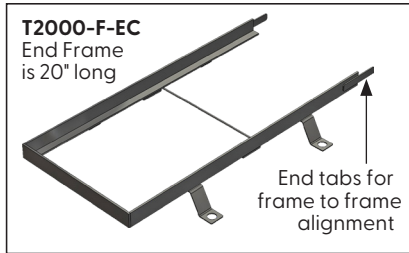

CHANNEL MODEL NUMBER	DESCRIPTION
T2000-F	8" internal width, powder epoxy coated steel frame
T2000-F-13	8" internal width, galvanized steel frame
T2000-F-EC	8" internal width, powder epoxy coated steel end frame, with two securing screws
T2000-F-EC-13	8" internal width, galvanized steel end frame, with two securing screws

Note: Must order in 20" long increments. 10' long sections are standard.

NOTES:

Revision Date: 08/11/2021

CALIFORNIA PROPOSITION 65 WARNING. This product contains chemicals known to the State of California to cause cancer and birth defects or other reproductive harm.

MIFAB reserves the right to make changes in material and design without formal notice and obligation. USA: 1-800-465-2736 www.mifab.com CAN: 1-800-387-3880