

Location:



Ductile Iron Heelproof Slotted Grate to suit 8" clear opening channels



Specification: T200-PGC-4-HP ductile iron heelproof slotted grates are independently certified to meet Load Class C tested in accordance with EN 1433 56,200 lbs. 250kN. The grate length is 19.69" (.50 m). The grates utilize the patented "Clipfix" grate locking mechanism. The system (channel and grate) provides longitudinal shift protection.

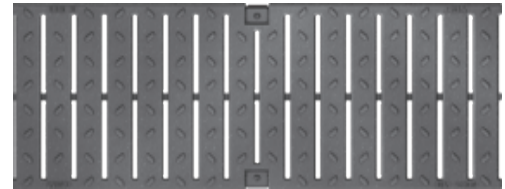
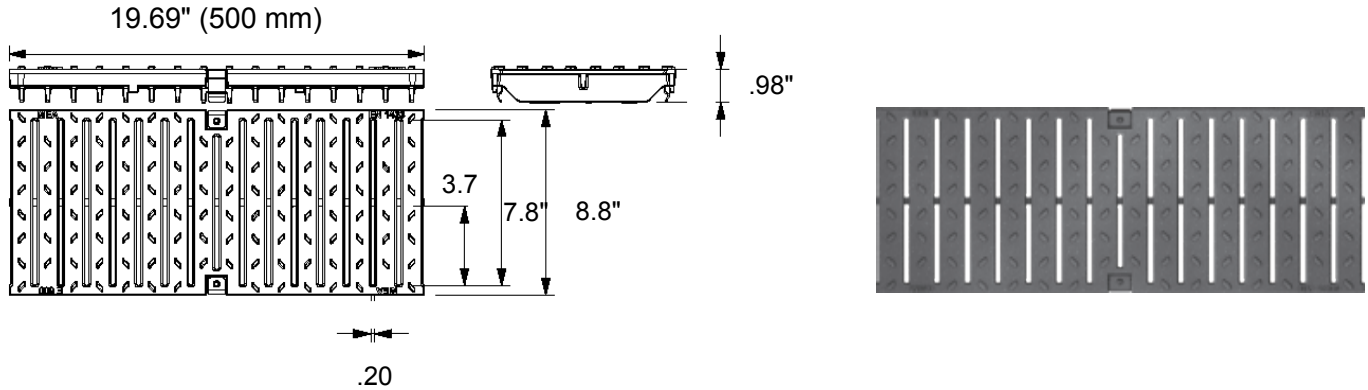

CLIPFIX ADVANTAGE

The MEA polymer concrete and GRP channels are designed for our universal CLIPFIX grate locking mechanism. The system (channel and grate) provides longitudinal shift protection.

LOAD CLASS C



EN 1433 -
56,200 LBS.,
250kN, 1160 PSI

Compliance



HEELPROOF

GRATE MODEL NUMBER	LENGTH
T200-PGC-4-HP	19.69" (500 mm)

Job Name: _____	Page No: _____
Section No: _____	Contractor: _____
Schedule No: _____	Purchase Order No: _____

Revision Date: 2023-02-06

CALIFORNIA PROPOSITION 65 WARNING. This product contains chemicals known to the State of California to cause cancer and birth defects or other reproductive harm.

MIFAB reserves the right to make changes in material and design without formal notice and obligation. USA: 1-800-465-2736 www.mifab.com CAN: 1-800-387-3880