

Location: _____



T1400-PBDS

BOTTOM OUTLET STRAINER FOR ALL T1400 GRP CHANNELS

Specification: MIFAB® T1400-PBDS bottom outlet strainer manufactured from powder coated 16 gauge galvanized steel.

Function: Used to provide a strainer above the bottom outlet for MIFAB's various T1400 GRP channels to prevent debris from entering and clogging the drain line.

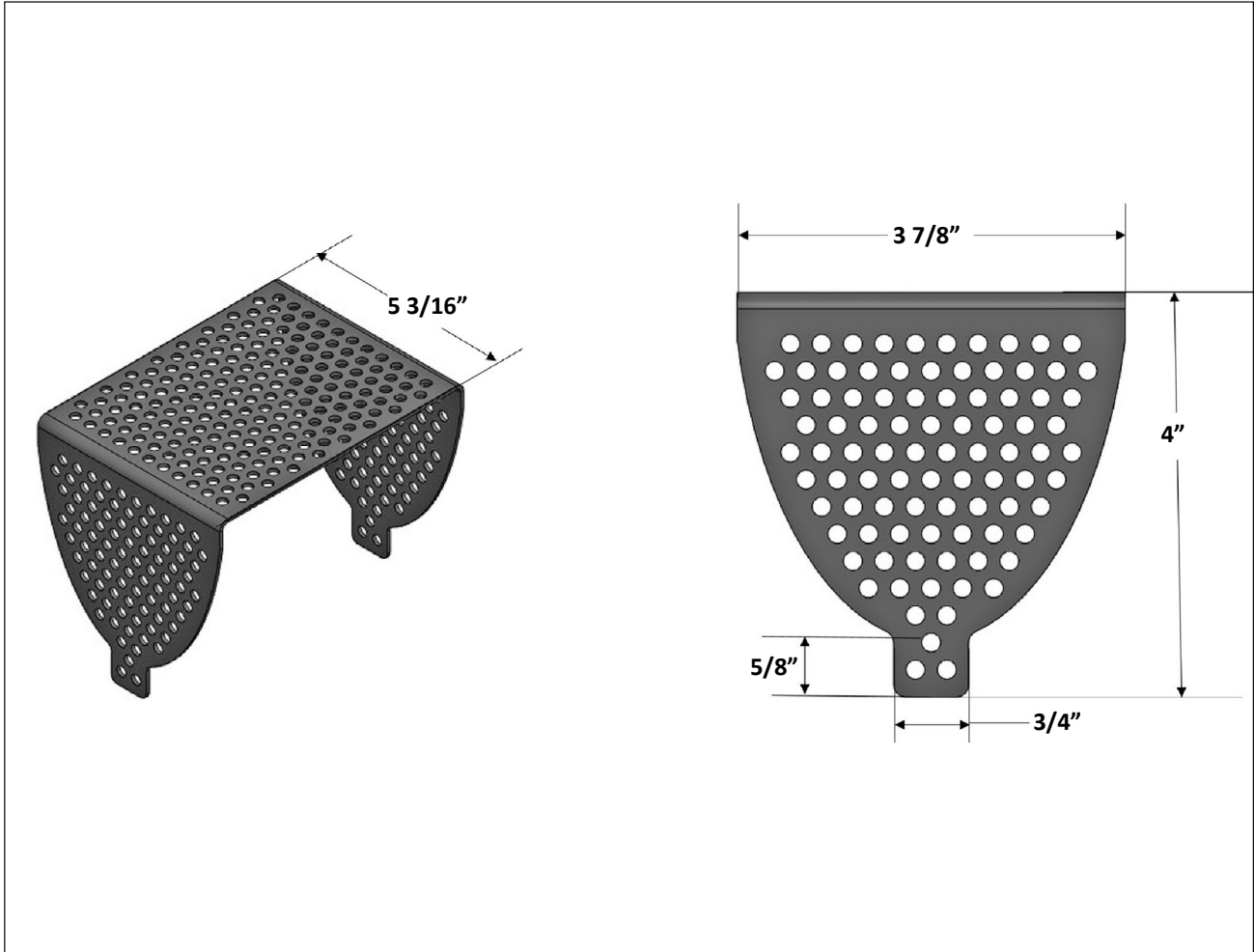

CALIFORNIA PROPOSITION 65 WARNING. This product contains chemicals known to the State of California to cause cancer and birth defects or other reproductive harm.

Job Name: _____ Page No: _____
Section No: _____ Contractor: _____
Schedule No: _____ Purchase Order No: _____

MIFAB reserves the right to make changes in material and design without formal notice and obligation. USA: 1-800-465-2736 www.mifab.com CAN: 1-800-387-3880

2023-04-25