

**T1350-FL
TRENCH DRAIN
INSTALLATION INSTRUCTIONS**

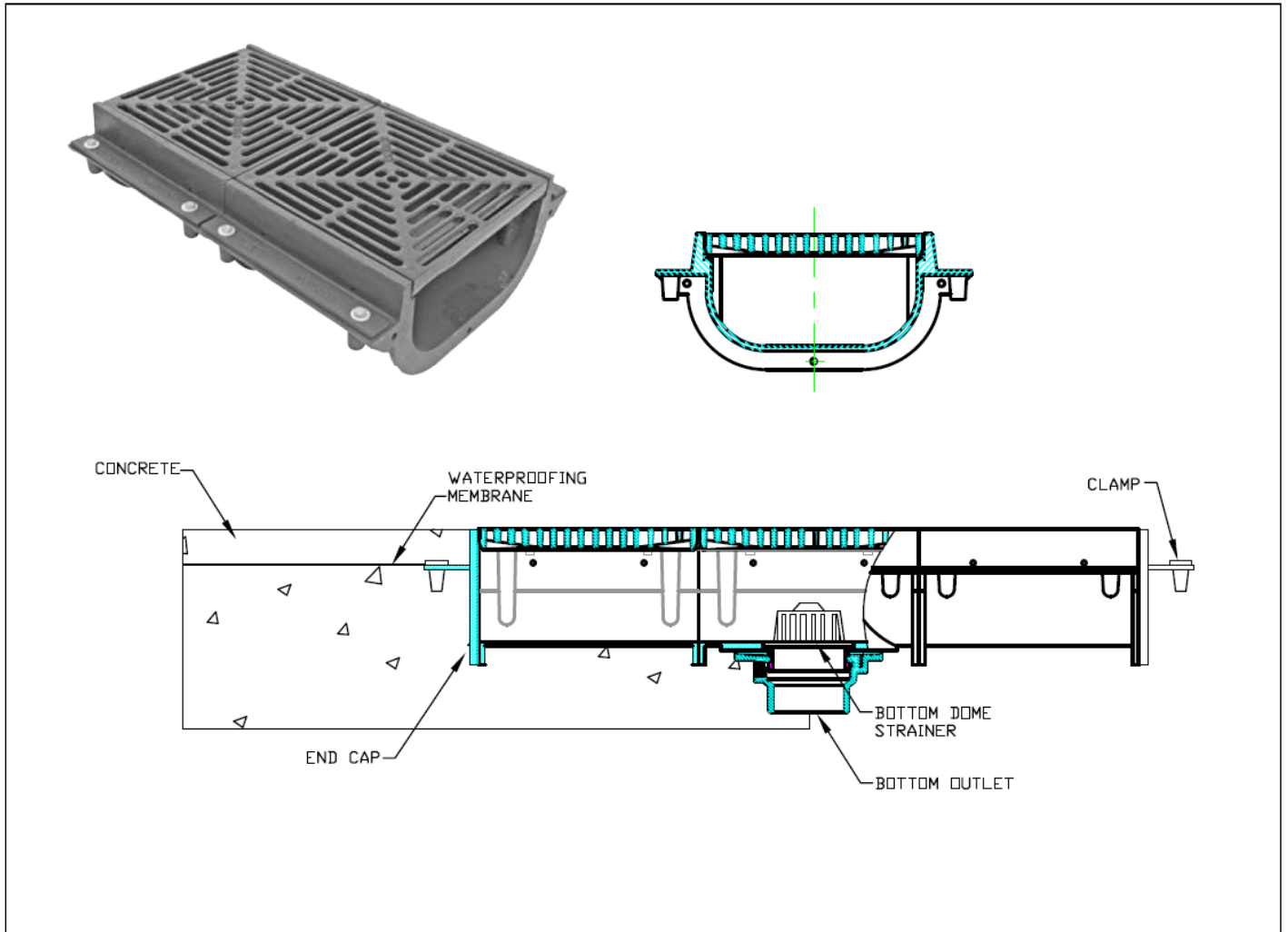

Extra-heavy-duty modular trench drain is illustrated in an above grade application, with bottom dome strainer and clamping collar (-C). This drain is used in areas where single drainage units are not practical. For example, where inclined or sloped surfaces require drainage across a wide area. The T1350-FL is also suited for vehicular traffic applications and grating may be ordered in ductile iron when greater load requirements are desired. Outlet and extension modules should be ordered in 12 [305] increments, and it is advisable that one outlet be used for each 8 foot [3 m] section of drain.



INSTRUCTIONS

1. For on grade applications, drain is to be set in place and supported at the proper elevation by gravel or other suitable material so that the concrete pour will not cause the drain to move.
2. When long runs are required it is recommended that most joints be made before setting the drain. The pipe is then attached to the drain by any one of the four connections offered by MIFAB.
3. For above grade applications, the structural pour is made, followed by a waterproofing membrane (when required). The membrane should be secured to the pan by use of a clamping collar. The floor is then finished flush with the top of the drain.