

Location: _____



R1530

DOWNSPOUT BOOTS

Specification: MIFAB® Series R1530 (specify type and size) lacquered cast iron downspout boot with wall securing clamp and hardware.

Function: Downspout boots are used as a transition piece for connecting sheet metal exposed downspouts to underground cast soil piping. Solid cast iron construction ensures that the bottom part of the exposed downspout is protected from damage.

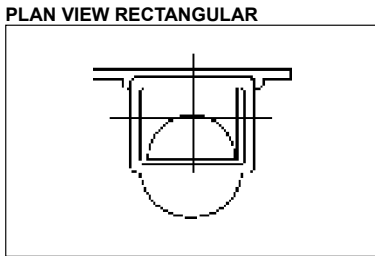
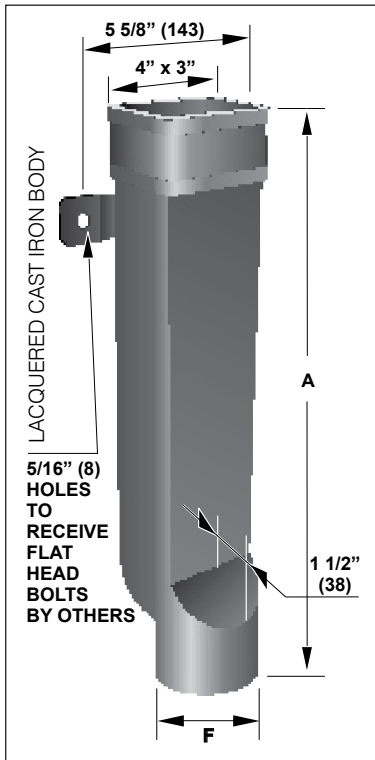

R1510
4" x 3" RECTANGULAR

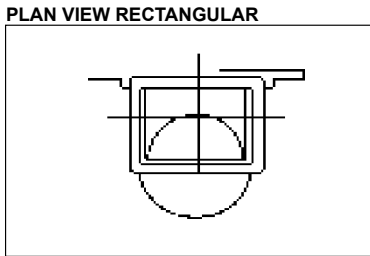
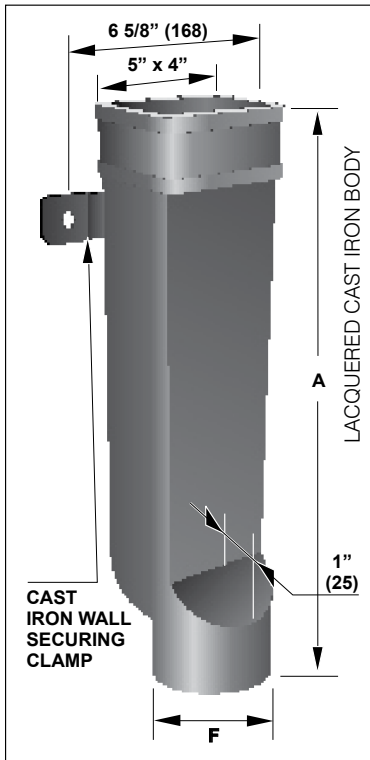

R1520
5" x 4" RECTANGULAR

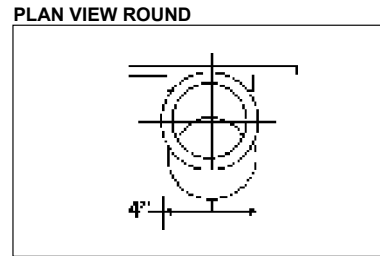
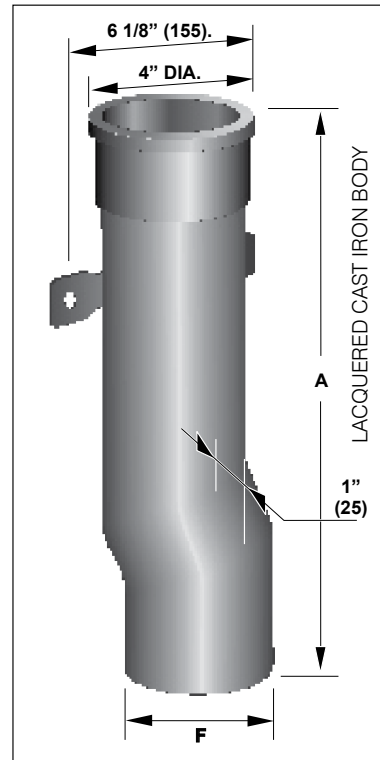

R1530
4" ROUND

MODEL NO.	BODY SIZE	A LENGTH	F NO HUB PIPE SIZE CONNECTION
R1510-12	4" x 3"	12"	4"
R1510-18	4" x 3"	18"	4"
R1510-24	4" x 3"	24"	4"
R1520	5" x 4"	24"	4"
R1530	4" x DIA.	18"	4"

- | | |
|---------------|--|
| SUFFIX | OPTIONAL VARIATIONS |
| -13 | All galvanized body |
| -BA | Buy America Act compliant product |
| -CA | Cleanout access with plug |
| -PA | Pennsylvania Steel Act compliant product |

CALIFORNIA PROPOSITION 65 WARNING. This product contains chemicals known to the State of California to cause cancer and birth defects or other reproductive harm.

Job Name: _____ Page No: _____
 Section No: _____ Contractor: _____
 Schedule No: _____ Purchase Order No: _____