

Location: _____



MI-O

**10 to 500 US G.P.M.
Oil Interceptor**

Specification: MIFAB® Series MI-O sanitary powder epoxy coated inside and outside fabricated 10 gauge steel oil interceptor. Unit to include: sediment bucket with perforated baffle near inlet, deep seal trap covered by lid, sewer gas stopper, securing bolt(s), removable baffle assembly and cross bar, stainless steel calibrated orifice plate, internal air relief by-pass, adjustable automatic draw-off assembly, double vent connection on each side, and steel powder epoxy coated non skid rectangular lid.

Function: Used in parking garages, service stations, and maintenance areas to receive wastewater that contains oil and sediment. The interceptor collects the oil before it is drained to an adjacent storage tank through an adjustable draw off system. Sediment and debris is collected inside of the internal sediment bucket. Regular maintenance is required to keep the interceptor functioning. Interceptor may be installed on the ground, semi recessed or flush with the floor. Sewer gas stopper prevents foul odors from entering the kitchen area through the interceptor.

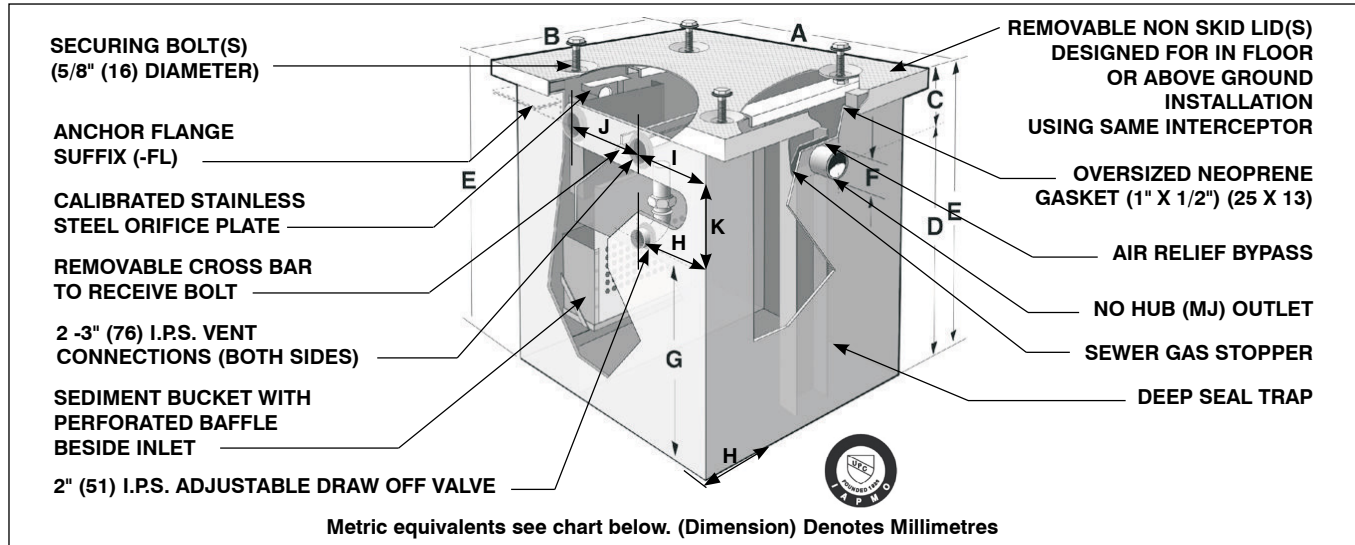

Metric equivalents see chart below. (Dimension) Denotes Millimetres

Note: The "C" dimension detailed above is from either the middle of the inlet or the outlet to the top the interceptor. The inlet and outlet dimensions are always the same.

MODEL NO.	US GPM	A	B	C	D	E	F (Inlet/Outlet)	G	H	I	J	K	HOLDING CAPACITY		NO. OF LIDS	NO. OF BOLTS	SHIPPING WEIGHT (lbs.)	WEIGHT WHEN FILLED WITH WATER (lbs.)
													U.S.G.	CU.FT				
MI-O-A	10	21.25" (531)	15.75" (394)	3.5" (88)	9.5" (238)	13" (325)	2" (51)	4" (102)	4	5.625	10	3.5	9.73	1.30	1	1	99	183
MI-O-B	15	23.75" (594)	15.75" (394)	3.5" (88)	11.5" (288)	15" (375)	2" (51)	5.5" (140)	4	6.875	10	3.5	13.59	1.82	1	1	115	232
MI-O-C	20	23.75" (594)	15.75" (394)	3.5" (88)	14" (350)	17.5" (438)	3" (75)	8" (203)	4	6.875	10	3.5	20.07	2.68	1	1	123	263
MI-O-1	25	28" (700)	22" (550)	6" (150)	26" (650)	32" (800)	3" (75)	19" (475)	4	9	10	4	55.15	7.37	1	4	240	712
MI-O-2	35	34" (850)	24" (600)	6" (150)	26" (650)	32" (800)	3" (75)	19" (475)	4	12	10	4	74.67	9.98	1	4	275	911
MI-O-3	50	34" (850)	24" (600)	6" (150)	28" (700)	34" (850)	3" (75)	21" (525)	4	12	10	4	80.76	10.80	1	4	285	973
MI-O-4	75	48" (1200)	34" (850)	8" (200)	28" (700)	36" (900)	4" (100)	21" (525)	4	19	10	4	165.68	22.15	2	8	475	1878
MI-O-5	100	51" (1275)	36" (900)	8" (200)	28" (700)	36" (900)	4" (100)	21" (525)	4	20.5	10	4	185.21	24.76	2	8	515	2082
MI-O-6	125	53" (1325)	36" (900)	8" (200)	28" (700)	36" (900)	4" (100)	21" (525)	4	21.5	10	4	195.17	26.09	2	8	530	2161
MI-O-7	150	58" (1450)	36" (900)	10" (250)	28" (700)	38" (950)	4" (100)	20.5" (521)	4	24	10	4	214.30	28.65	3	12	580	2371
MI-O-8	200	68" (1700)	38" (950)	10" (250)	32" (800)	42" (1050)	4" (100)	25" (625)	4	29	10	4	308.57	41.25	4	8	700	3279
MI-O-9	250	74" (1850)	40" (1000)	12" (300)	38" (950)	50" (1250)	4" (100)	31" (775)	4	32	10	4	426.39	57.00	4	8	1065	4628
MI-O-10	300	78" (1950)	44" (1100)	12" (300)	40" (1000)	52" (1300)	4" (100)	33" (825)	4	34	10	4	549.71	73.49	4	8	1190	5578
MI-O-11	350	80" (2000)	46" (1150)	12" (300)	40" (1000)	52" (1300)	6" (150)	33" (825)	4	35	10	4	621.30	83.06	6	24	1285	5878
MI-O-12	400	82" (2050)	48" (1200)	12" (300)	42" (1050)	54" (1350)	6" (150)	35" (875)	4	36	10	4	664.52	88.83	6	24	1360	6551
MI-O-13	450	84" (2100)	50" (1250)	12" (300)	42" (1050)	54" (1350)	6" (150)	35" (875)	4	37	10	4	690.91	92.36	6	24	1405	6958
MI-O-14	500	86" (2850)	52" (1300)	12" (300)	46" (1150)	58" (1450)	6" (150)	39" (975)	4	38	10	4	781.82	104.51	6	24	1515	8048

Note: Reduce the "A" and "B" dimensions by 1" (25) to determine the actual body length and width dimensions. The lid overhangs the body by 1/2" (13) on all four sides.

SUFFIX	OPTIONAL VARIATIONS	SUFFIX	OPTIONAL VARIATIONS
-AL	Aluminum lid(s)	-FLC	Flow control fitting
-AP	Anode pack	-FLM	Anchor flange and membrane clamp
-BA	Buy American Act compliant product	-HD	Heavy Duty load rated lids
-C	Extension "C" as required	-HLA	High level alarm
specify	Special size inlet and outlet	-HT	Holding tank to receive waste oil
-DW	Double wall contained interceptor	-SS	Stainless steel cover shroud
-DWHT	Double wall contained holding tank	-T	F.I.P. female threaded inlet and outlet
-FL	Anchor flange	-TL	Lid (s) to receive tile or terrazzo

CALIFORNIA PROPOSITION 65 WARNING. This product contains chemicals known to the State of California to cause cancer and birth defects or other reproductive harm.

Job Name: _____ Page No: _____
 Section No: _____ Contractor: _____
 Schedule No: _____ Purchase Order No: _____