

OPERATIONS MANUAL FOR THE MI-NEUT-MONITOR pH Monitor

MI-NEUT-MONITOR pH Monitor System

Safety Notes

Please observe the notes in these operating instructions in conjunction with the data provided are supplied in order to maximize the efficiency and operation of the system:

- Installation and maintenance work is to be performed only by qualified personnel whom are certified for the actions to be completed and understand fully the scope of work.
- Tools used for installation and/or maintenance are to be appropriate for the application.
- Switch off the supply voltage to the enclosure prior to any work performed in all cases.
- Safety precautions must be taken when dealing with any part of the system that is under pressure prior to commencement.
- Take suitable precautions to prevent inadvertent operation or damage by unauthorized action.

Delivery

Immediately after receipt of the system, verify all components are undamaged and match the packing slip accompanying the shipment. If there are any discrepancies, please contact MIFAB.

General

Only properly trained and qualified individuals should perform installation procedures. Failure to follow the instructions held within or use of improper tools and procedures during the installation will invalidate the system warranty.

Ensure that all fittings and terminations are retightened before installation as they may have come loose during shipping.

Electrical Power Requirements

All electrical connections should be sealed properly to prevent water from entering the conduit. Failure to do so will invalidate the warranty.

Follow local, State, and Federal regulations in addition to all company policies in regard to wiring.

It is up to the installation team to determine and follow relevant guidelines.

The power supply to the panel should be conditioned in order to protect the system, as well as ensure proper operation. Voltage sags and spikes can be damaging over time.

At the time of commissioning, it is suggested that the incoming power source is verified before applying power to the system. (i.e. voltage, phase and frequency)

Refer to the electrical drawings for the system power supply and wiring interconnection requirements. A visual inspection is necessary to verify that no damage occurred during shipment and that there are no loose wire terminations.

MI-NEUT-MONITOR
pH Monitor System

Equipment Installation and Commissioning Procedure

- 1) Connect external devices in accordance with drawing.
- 2) Ensure incoming power from the main power source is removed prior and all Lock out Tag out procedures are followed.
- 3) Verify the Main Circuit breaker is in the "OFF" position.
- 4) Connect pH Probes
- 5) Connect Tank Level, Containment switches and Chemical Tank level Inputs
- 6) Connect BMS Outputs if appropriate.
- 7) Verify all circuit breakers are in the "ON" position prior to placing the main circuit breaker in the "ON" position.
- 8) Close and latch the Enclosure door.
- 9) Verify proper voltage at the main power source and apply external power to the enclosure
- 10) System will power up and PLC will initialize. This will take a few minutes to fully initialize. Upon completion you should see appropriate values populate the pH fields.

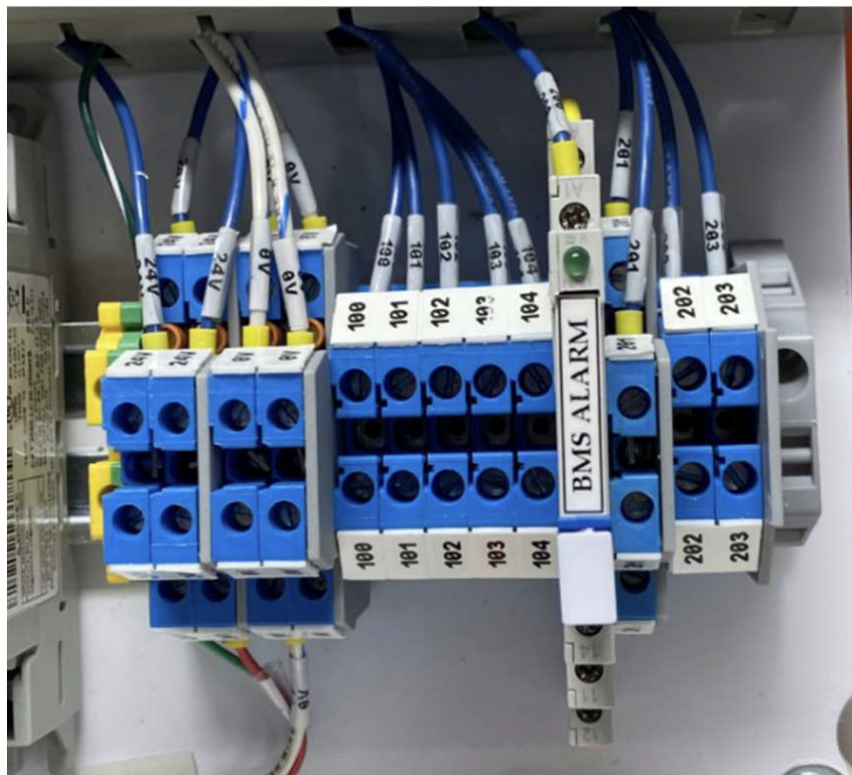

MI-NEUT-MONITOR pH Monitor System

Main Enclosure: Layout Exterior

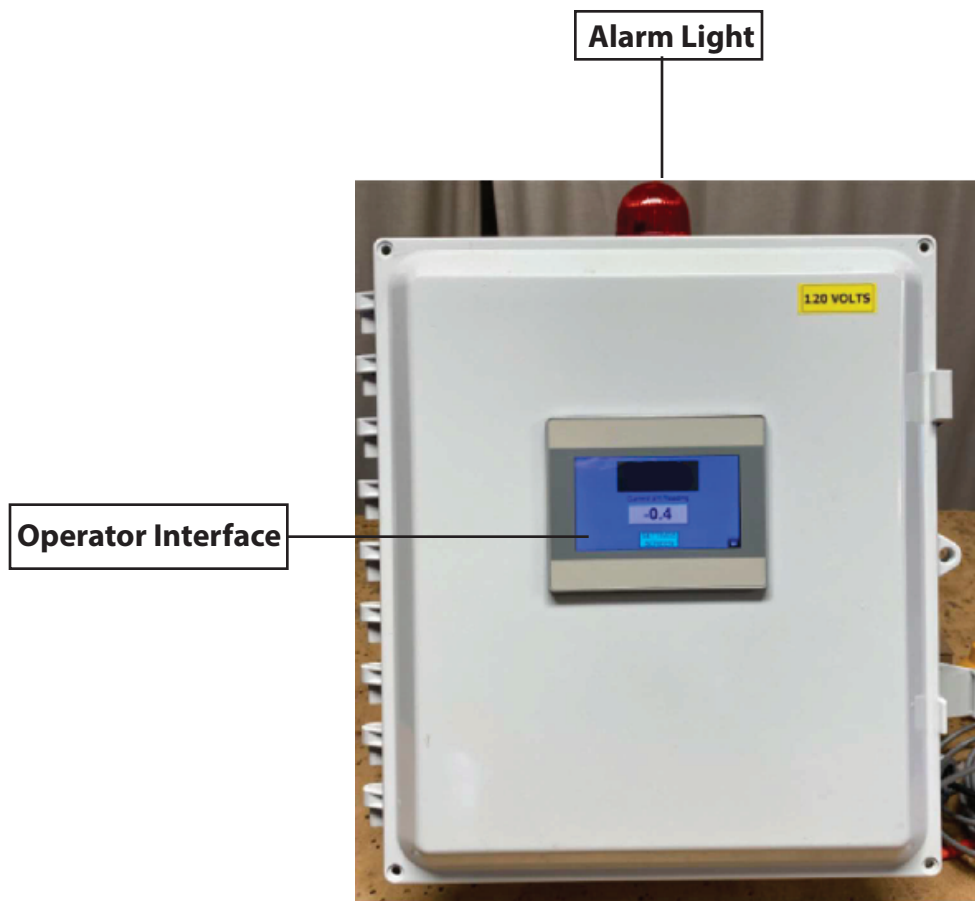

MI-NEUT-MONITOR pH Monitor System

Main Enclosure: Layout Interior

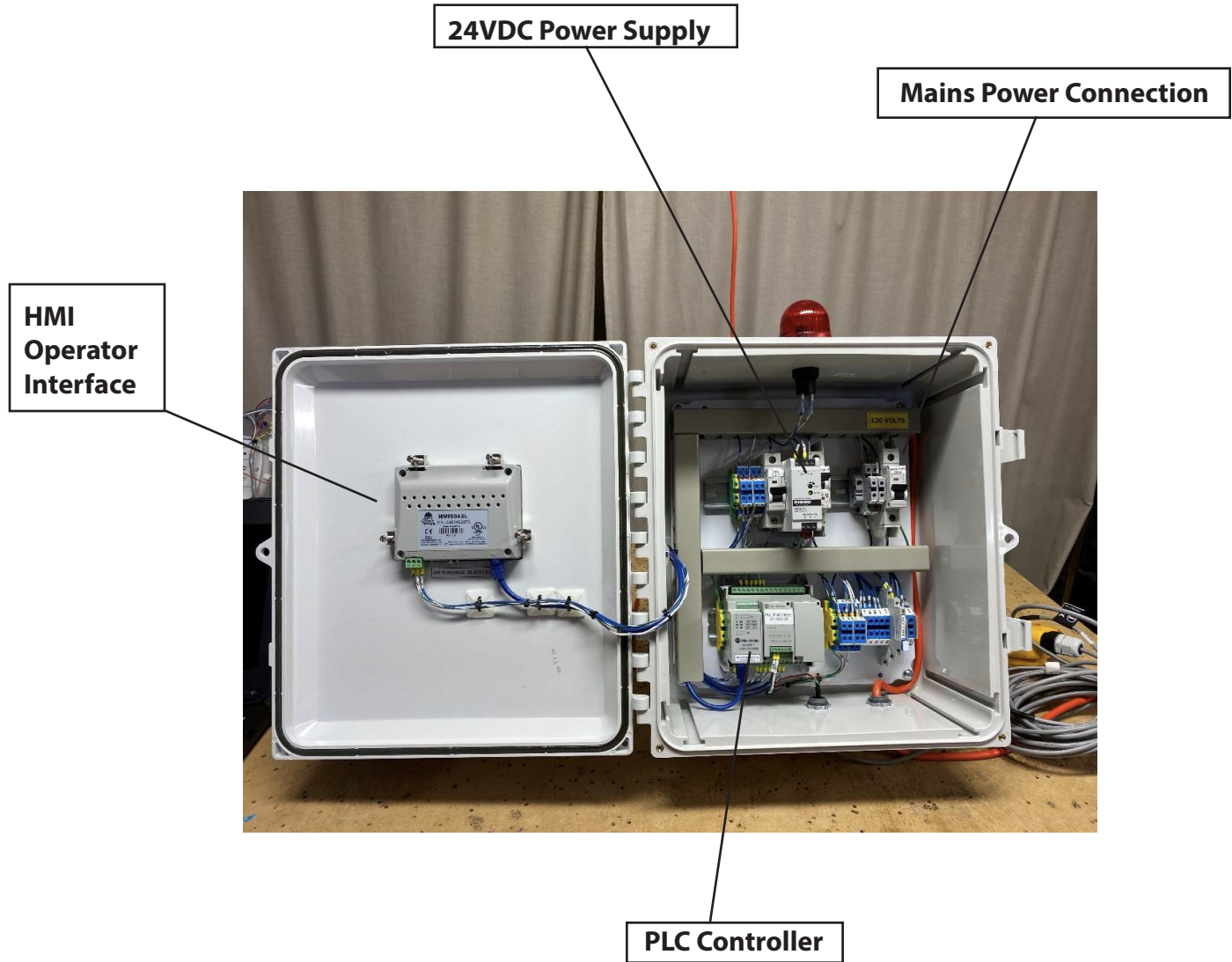

MI-NEUT-MONITOR pH Monitor System

HMI Layout: Main Screen Layout

- pH Meter -Compliance Probe current reading
- Chart Screen PB allows access to the chart screen
- Setting Screen PB allows access to the Timer and pH setting values and parameters

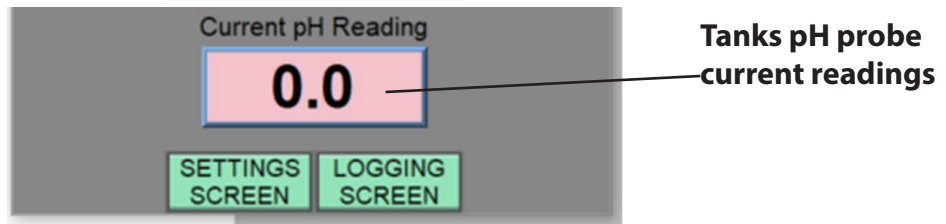
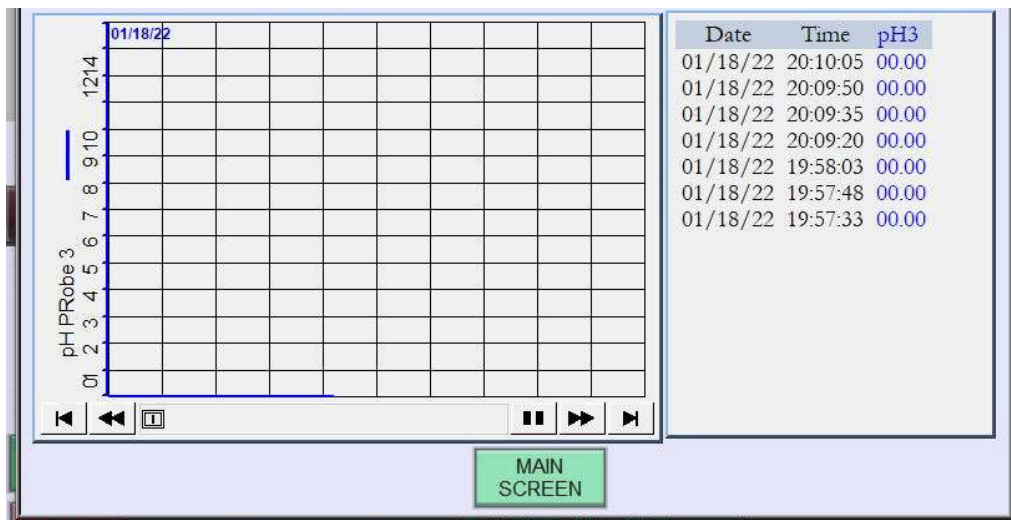

Chart Screen

Displays and Charts the Current and archival value of the Compliance probe pH.



MI-NEUT-MONITOR pH Monitor System

Setting Screen

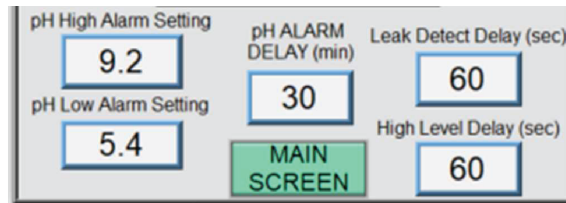

1. Settings screen allows for manipulation of the pH limits for all probes as well as the Mixer ON/OFF Delays and Alarm Delay Timer.
2. pH Low Limit – Enter the value of the lower limit for allowable pH
3. pH High Limit – Enter the value of the upper limit for allowable pH
4. pH Alarm Delay – Enter the time period when expired will turn on the Alarm
5. Leak Detect Alarm Delay – Enter the time period when expired will turn on the Alarm
6. High Level Detect Alarm Delay – Enter the time value that the system will delay until the alarm sounds

Chart recorder download

1. To obtain the historical values of the Chart Recorder you must remove the USB drive from the back of the HMI.
2. You must first download the EB pro full program from Maple Systems
3. <https://www.maplesystems.com/supportcenter/-softwaredownloads.htm>
4. Remove power from the system and open the enclosure door.
5. Locate the USB drive on the backside of the HMI.
6. Remove the USB drive and download the .DTL file to your computer
7. Open the Maple Systems folder and open the Utility manager.

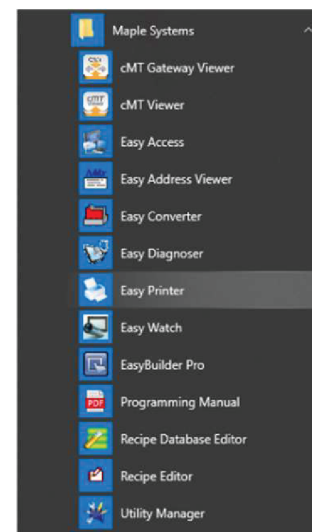

MI-NEUT-MONITOR pH Monitor System

Open the Easy Converter

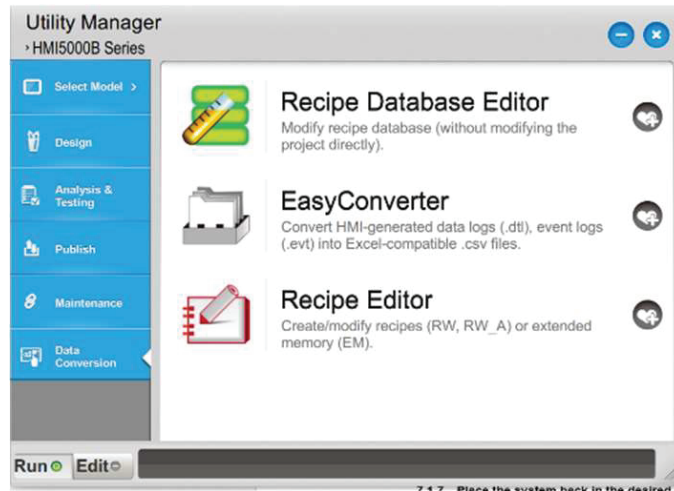

Find your saved file

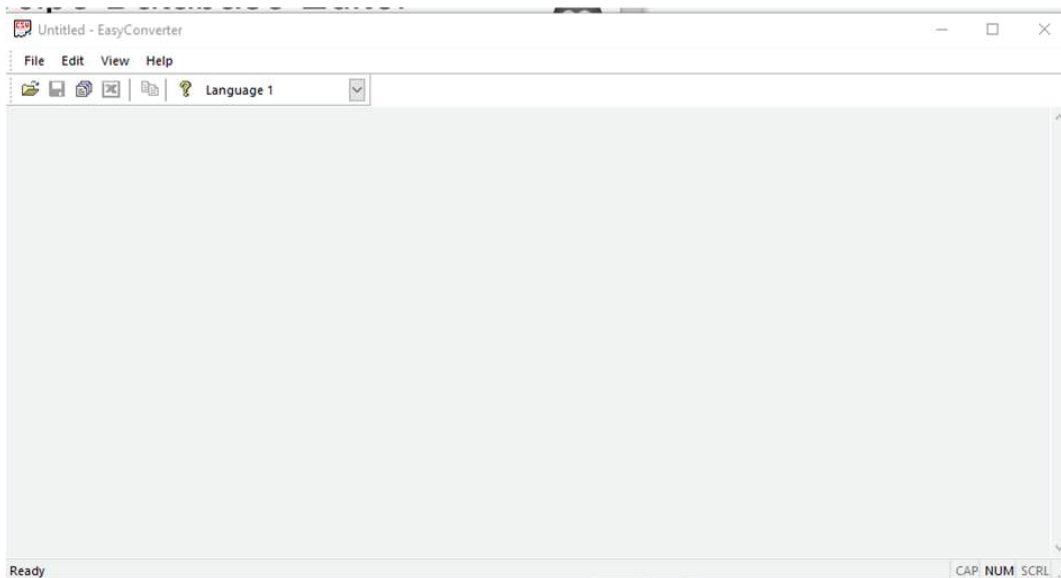

MI-NEUT-MONITOR pH Monitor System

Open “File” and click on the “Export to Microsoft Excel” file tab. The system will create an Excel file and will open Microsoft Excel. Save the file to your desired location.

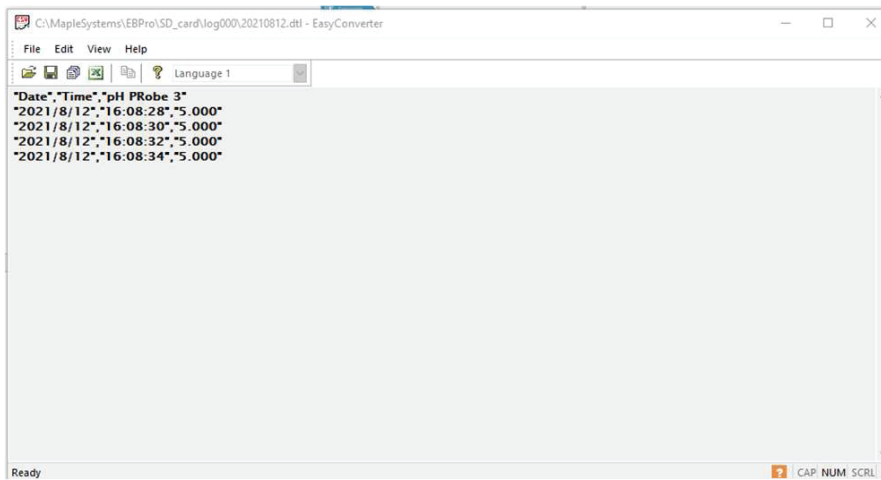

Replace the USB drive and restore power.

MI-NEUT-MONITOR pH Monitor System

Schematic

