



Distributed by: **MIFAB**



CERTIFIED
MANAGEMENT SYSTEM
ISO 9001:2015

*"The product we have sold is well built..
I have no call backs on the units that
we have in the field at Ft. Indiantown
Gap Army Depot and the catalog is an
easy read to find the product"*

- Dave Roberts, Maryland Pipe & Supply

BEECO-2019-07

<http://www.mifab.com/Specifications/index.html>

















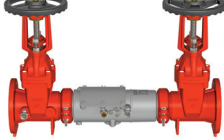





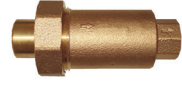







Backflow Preventers & Accessories

LIT-071

“Mifab Products are by far the best, easy to install and so well thought out. No other manufacturer makes their products so simple to use. Mifab is the only way to go.”

- Joe Boyle, Boyle Plumbing & Contracting, Inc.

 <p>ACV : PG 2-10</p>	 <p>ACV 500 Series - PG 8-10</p>	 <p>ASVB : PG 58</p>	 <p>AV-P : PG 22</p>	
 <p>AV-WP : PG 23</p>	 <p>BALL CHECK : PG 68</p>	 <p>BALL VALVE : PG 60-61</p>	 <p>BARRACUDA 20 FDC : PG 33</p>	 <p>BARRACUDA 40 FRP : PG 47</p>
 <p>CV : PG 58</p>	 <p>DCAV : PG 16</p>	 <p>DCDA : PG 30</p>	 <p>DIELECTRIC UNIONS : PG 69</p>	 <p>DUAL CHECK : PG 51</p>
 <p>FDC : PG 24-29</p>	 <p>FLEX CHECK : PG 68</p>	 <p>FRP : PG 39-43</p>	 <p>GATE VALVES : PG 63-66</p>	 <p>HBVB : PG 59</p>
 <p>MI-CONTROL : PG 58</p>	 <p>PG : PG 62-63</p>	 <p>PRV : PG 11-15</p>	 <p>PVB : PG 16</p>	 <p>BACKFLOW REPAIR KITS : PG 53-57</p>
 <p>RPDA : PG 44</p>	 <p>SCV : PG 67</p>	 <p>STR-BRZ : PG 60</p>	 <p>STR-DI : PG 59</p>	 <p>TK : PG 52</p>

PRODUCT	PAGE NO.
----------------	-----------------

AIR RELEASE VALVES

AIR RELEASE VALVES (-MH)	19
AIR RELEASE VALVES (-MS).....	19
AIR RELEASE VALVES (-HP)	20
AIR RELEASE VALVES PLASTIC	22
AIR RELEASE VALVES (-WP)	23

AUTOMATIC CONTROL VALVES

AUTOMATIC CONTROL VALVES	2-10
--------------------------------	------

BACKFLOW PREVENTERS

AIR GAPS.....	52
BARRACUDA 20G FDC	33-36
BARRACUDA 40 FRP	47-50
DCAV DUAL CHECK WITH ATMOSPHERIC VENT..	16
DOUBLE CHECK (GROOVED).....	29
DOUBLE CHECK (LARGE).....	27
DOUBLE CHECK STAINLESS STEEL.....	33-36
DOUBLE CHECK (SMALL)	26
DOUBLE CHECK DETECTOR ASSEMBLY.....	30
DOUBLE CHECK VALVES	51
FDC-REPAIR KITS	54
FRP-REPAIR KITS	54
OLD HERSEY BEECO REPAIR KITS	56
PVB PRESSURE VACUUM BREAKER	16
REDUCED PRESSURE (LARGE).....	40
REDUCED PRESSURE STAINLESS STEEL ..	47-50
REDUCED PRESSURE (SMALL).....	39
REDUCED PRESSURE	42
REPLACEMENT BACKFLOW CHECKS	55
RIGID PIPE COUPLINGS	53
SPOOLS AND SPACERS	53
TEST KITS.....	52

CHECK VALVES

CHECK VALVES.....	58
CHECK VALVES, SWING.....	66
CHECK VALVES, SILENT	67
CHECK VALVES, FLEX.....	68
CHECK VALVES, BALL	68

DIELECTRIC UNIONS

DIELECTRIC UNIONS	69
-------------------------	----

GATE VALVES

GATE VALVES.....	63
GATE VALVES, FLANGED BY GROOVED.....	65
GATE VALVES, FLANGED BY FLANGED	65
GATE VALVES, MECHANICAL JOINT	66

PRODUCT	PAGE NO.
----------------	-----------------

PLUG VALVES

PLUG VALVE, ECCENTRIC	69
-----------------------------	----

PRESSURE GAUGES

PRESSURE GAUGES, BOTTOM ENTRY	62
PRESSURE GAUGES, BACK ENTRY	62
PRESSURE GAUGES, TOP ENTRY	59

PRESSURE REDUCING VALVES

PRV-C-LL SERIES.....	11
PRV-JK SERIES COMPACT DESIGN ONLY	13
PRV REPAIR KITS	14

STRAINERS

STRAINERS, DUCTILE IRON.....	59
STRAINERS, POWDER COATED DUCTILE IRON ..	59
STRAINERS, LOW LEAD THREAD CONNECTION	60
STRAINERS, LOW LEAD SWEAT CONNECTION.....	60

VACUUM BREAKERS

VACUUM BREAKERS, ANTI-SIPHON	58
VACUUM BREAKERS, HOSE CONNECTION.....	59

WATER HEATER SHUTOFF CONTROL VALVE

MI-CONTROL	58
------------------	----

CROSS REFERENCE

AUTOMATIC CONTROL VALVES (ACV)	70, 75
AIR AND VACUUM VALVES.....	70
BACKFLOW PREVENTERS	72, 73
CASH ACME.....	74
CHECK AND PLUG VALVES.....	73
CLA-VAL	75
COMBINATION AIR VALVES	71
CONBRACO	74, 75
DEEP WELL VALVES	72
WATTS GROUP, FLOWMATIC.....	76
HERSEY	76
UNIVERSAL AIR RELEASE VALVES.....	71
WATTS GROUP.....	75
WATTS GROUP, AMES	74
WATTS GROUP, FEBCO.....	75, 76
WATTS.....	76
WILKINS	75, 76

ABBREVIATIONS.....	77
--------------------	----

TERMS AND CONDITIONS	80
----------------------------	----

BEECO AUTOMATIC CONTROL VALVES

BEECO Automatic Control Valves are used in a variety of Commercial Plumbing, Industrial and Institutional control applications. They are actuated by various hydraulic and/or electric pilot controls, and utilize line pressure to perform a wide range of On-Off, Regulating, and Combination control functions.

- PRESSURE REDUCING
- SOLENOID (On-Off) CONTROL
- LIQUID LEVEL CONTROL
- FLOW CONTROL
- PRESSURE RELIEF, SUSTAINING, & BACKPRESSURE CONTROL
- ELECTRONIC REGULATING CONTROL (SCADA Control)
- PUMP AND WELL CONTROL
- SYSTEM SAFETY & PROTECTION CONTROL

BEECO Automatic Control Valves are constructed of ductile iron and are 100% coated with an extremely durable, high-quality electrostatic fusion bonded epoxy coating as standard. They are available in 1-1/2" through 24" Full Port (-HF) and 2" through 32" Reduced Port designs, with FNPT Threaded (-IPS), ANSI Class 150 or 300 Flanged (-HP) end connections. Every BEECO Automatic Control Valve is hydrostatically tested to ensure peak performance and boast standard features not found in other Automatic Control Valves such as:

- DUCTILE IRON BODY & COVER
- STAINLESS STEEL MAIN VALVE INTERNALS*
- **316 STAINLESS STEEL MAIN VALVE TRIM**
- "NEAR-ZERO" LOW FLOW PERFORMANCE
- FUSION BONDED EPOXY COATED 100% INSIDE AND OUTSIDE
- STAINLESS STEEL BODY & COVER PORT SLEEVES
- STAINLESS STEEL FASTENERS*
- EPDM RUBBER COMPONENTS
- ISO STANDARD LENGTHS AND DIMENSIONS
- CERTIFIED LEAD FREE

* 6" AND SMALLER

BEECO also offers Automatic Control Valves in complete 316 Stainless Steel for the ultimate in performance and corrosion resistance. Consult your BEECO representative for more details.

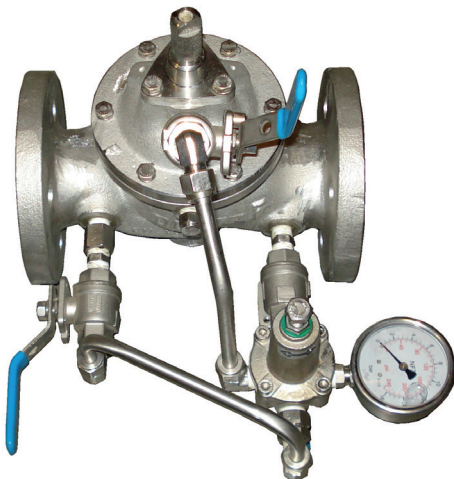

AUTOMATIC CONTROL VALVES

ELECTRIC OVERRIDE SAFETY SHUT OFF VALVE

FLANGED BY FLANGED (ANSI 150)				
Model Number	Size	Qty. per Carton	Weight per Carton (Lbs.)	List Price (Each)
ACV1.50HF-EOSSV	1.5"	1	32	\$16,055
ACV2.00HF-EOSSV	2"	1	32	\$16,055
ACV2.50HF-EOSSV	2 1/2"	1	32	\$16,363
ACV3.00HF-EOSSV	3"	1	55	\$18,673
ACV4.00HF-EOSSV	4"	1	88	\$20,598
ACV6.00HF-EOSSV	6"	1	182	\$21,560

FLANGED BY FLANGED (ANSI 150)				
Model Number	Size	Qty. per Carton	Weight per Carton (Lbs.)	List Price (Each)
ACV3.00-PR	3"	1	38	\$4,582
ACV4.00-PR	4"	1	65	\$6,045
ACV6.00-PR	6"	1	117	\$9,664
ACV8.00-PR	8"	1	207	\$13,812
ACV10.00-PR	10"	1	382	\$27,759

REDUCED PORT PRESSURE SUSTAINING VALVES

FLANGED BY FLANGED (ANSI 150)				
Model Number	Size	Qty. per Carton	Weight per Carton (Lbs.)	List Price (Each)
ACV3.00-PS	3"	1	38	\$4,582
ACV4.00-PS	4"	1	65	\$6,045
ACV6.00-PS	6"	1	117	\$9,664
ACV8.00-PS	8"	1	207	\$13,812
ACV10.00-PS	10"	1	382	\$27,759

REDUCED PORT ELECTRIC ACTUATED

FLANGED BY FLANGED (ANSI 150)				
Model Number	Size	Qty. per Carton	Weight per Carton (Lbs.)	List Price (Each)
ACV3.00-EL	3"	1	38	\$5,201
ACV4.00-EL	4"	1	65	\$6,280
ACV6.00-EL	6"	1	117	\$9,165
ACV8.00-EL	8"	1	207	\$13,880
ACV10.00-EL	10"	1	382	\$30,993

ACV4.00-HF-EOSSV (SHOWN WITH STANDARD TUBING & FITTINGS)

FOR SPEC. SHEETS GO TO www.beecobackflow.com



WORKING PRESSURE: 250 psi
BODY & COVER: Epoxy Coated Ductile Iron
ELASTOMERS: EPDM
TUBING / FITTINGS: Reinforced Nylon w/ Brass Fittings
CONTROL PILOT(S): Bronze / Brass

Optional at extra charge (consult BEECO):

- Copper Tubing & Brass Fittings
- Stainless Steel Tubing & Fittings

ACV4.00-PR (SHOWN WITH OPTIONAL STAINLESS STEEL PILOT CONTROL SYSTEM)

FOR SPEC. SHEETS GO TO www.beecobackflow.com



BEECO -PR Series Pressure Reducing Valves are designed to reduce a fluctuating high upstream pressure to an adjustable constant lower downstream pressure regardless of varying flow demand.

BEECO -PS Series Pressure Sustaining Valves are designed to maintain an adjustable minimum upstream pressure, and are normally installed between two pressure zones (Pressure Sustaining Control) or on the discharge side of a pump (Backpressure Control).

WORKING PRESSURE: 250 psi
BODY & COVER: Epoxy Coated Ductile Iron
ELASTOMERS: EPDM
TUBING / FITTINGS: Reinforced Nylon w/ Brass Fittings
CONTROL PILOT(S): Bronze / Brass

Optional at extra charge (consult BEECO):

- Copper Tubing & Brass Fittings
- Stainless Steel Tubing & Fittings
- Complete Stainless Steel Control System

"Another manufacturer dropped the ball and I was able to get a Beeco ACV PRV quickly. The customer was skeptical because it looked different due to not having a bypass. The rep assured him it was not needed with a Beeco ACV and walked him through the installation"

- Brian Churilla, National Plumbing & Heating



Distributed by: MIFAB®

ACV4.00-HF-FLDI1 (SHOWN WITH OPTIONAL STAINLESS STEEL PILOT CONTROL SYSTEM)

FOR SPEC. SHEETS GO TO www.beecobackflow.com



BEECO -FLDI1 Series On-Off Differential Level Control Valves are designed to control the liquid level in a storage tank or reservoir. It has separate adjustable Opening (Low Level) and Closing (High Level) set-points allowing for optimum water turn-over to avoid stagnation.

- WORKING PRESSURE:** 250 psi
- BODY & COVER:** Epoxy Coated Ductile Iron
- ELASTOMERS:** EPDM
- TUBING / FITTINGS:** Reinforced Nylon w/ Brass Fittings
- CONTROL PILOT(S):** Bronze / Brass Standard w/ (2) 24" Float Rods
- Optional at extra charge (consult BEECO):**
 - Copper Tubing & Brass Fittings
 - Stainless Steel Tubing & Fittings
 - Complete Stainless Steel Control System

BEECO -FLEL Series Electric On/Off Level Control Valves open or close fully when the Solenoid is energized by the Electric Float Switch (included). Solenoid enclosure is standard NEMA 4 110-120 VAC.

FOR SPEC. SHEETS GO TO www.beecobackflow.com

"The Beeco ACV's are the easiest and most reliable control valve we have ever installed. We have been using nothing else for several years and have never had an issue"

- Jeff Yosko, MTM Mechanical

REDUCED PORT DIFFERENTIAL LEVEL CONTROL VALVE

FLANGED BY FLANGED (ANSI 150)				
Model Number	Size	Qty. per Carton	Weight per Carton (Lbs.)	List Price (Each)
ACV2.50-FLDI1	3"	1	38	\$5,968
ACV3.00-FLDI1	3"	1	38	\$5,968
ACV4.00-FLDI1	4"	1	65	\$7,123
ACV6.00-FLDI1	6"	1	117	\$11,743
ACV8.00-FLDI1	8"	1	207	\$16,324
ACV10.00-FLDI1	10"	1	382	\$24,255

REDUCED PORT LEVEL CONTROL VALVE ELECTRIC ON/OFF

FLANGED BY FLANGED (ANSI 150)				
Model Number	Size	Qty. per Carton	Weight per Carton (Lbs.)	List Price (Each)
ACV2.50-FLEL	3"	1	38	\$4,582
ACV3.00-FLEL	3"	1	38	\$4,582
ACV4.00-FLEL	4"	1	65	\$5,660
ACV6.00-FLEL	6"	1	117	\$8,624
ACV8.00-FLEL	8"	1	207	\$13,341
ACV10.00-FLEL	10"	1	382	\$24,525

FULL PORT HIGH FLOW PRESSURE REDUCING VALVES

FLANGED BY FLANGED (ANSI 150)				
Model Number	Size	Qty. per Carton	Weight per Carton (Lbs.)	List Price (Each)
ACV1.50-HF-PR	1 1/2"	1	32	\$4,120
ACV2.00-HF-PR	2"	1	32	\$4,120
ACV3.00-HF-PR	3"	1	55	\$6,430
ACV4.00-HF-PR	4"	1	88	\$8,201
ACV6.00-HF-PR	6"	1	182	\$14,245
ACV8.00-HF-PR	8"	1	351	\$27,335
ACV10.00-HF-PR	10"	1	545	\$33,795

ACV4.00-HF-PR (SHOWN WITH OPTIONAL STAINLESS STEEL PILOT CONTROL SYSTEM)

FOR SPEC. SHEETS GO TO www.beecobackflow.com



BEECO -PR Series Pressure Reducing Valves are designed to reduce a fluctuating high upstream pressure to an adjustable constant low downstream pressure regardless of varying flow demand.

- WORKING PRESSURE:** 250 psi
BODY & COVER: Epoxy Coated Ductile Iron
ELASTOMERS: EPDM
TUBING/FITTINGS: Reinforced Nylon w/ Brass Fittings
CONTROL PILOT(S): Bronze / Brass
Optional at extra charge (consult BEECO):
- Copper Tubing & Brass Fittings
 - Stainless Steel Tubing & Fittings
 - Complete Stainless Steel Control System

FULL PORT HIGH FLOW PRESSURE SUSTAINING VALVES

FLANGED BY FLANGED				
Model Number	Size	Qty. per Carton	Weight per Carton (Lbs.)	List Price (Each)
ACV1.50-HF-PS	1 1/2"	1	32	\$4,120
ACV2.00-HF-PS	2"	1	32	\$4,120
ACV3.00-HF-PS	3"	1	55	\$6,430
ACV4.00-HF-PS	4"	1	88	\$8,201
ACV6.00-HF-PS	6"	1	182	\$14,245
ACV8.00-HF-PS	8"	1	351	\$27,335
ACV10.00-HF-PS	10"	1	545	\$33,795

ACV4.00-HF-PS (SHOWN WITH OPTIONAL STAINLESS STEEL PILOT CONTROL SYSTEM)

FOR SPEC. SHEETS GO TO www.beecobackflow.com



BEECO -PS Series Pressure Sustaining Valves are designed to maintain an adjustable minimum upstream pressure, and are normally installed between two pressure zones (Pressure Sustaining Control) or on the discharge side of a pump (Backpressure Control).

ACV4.00-HF-EL (SHOWN WITH OPTIONAL STAINLESS STEEL PILOT CONTROL SYSTEM)

 FOR SPEC. SHEETS GO TO www.beecobackflow.com

BEECO -EL Series Solenoid (On-Off) Control Valves are designed to open or close fully in response to an electrical signal.

The valve is used in a variety of applications including Zone Control, Liquid Level Control and Batching Control installations. Solenoid Enclosure is standard NEMA 4 110-120 VAC. Specify Energize to OPEN or CLOSE valve prior to ordering.

WORKING PRESSURE: 250 psi
BODY & COVER: Epoxy Coated Ductile Iron
ELASTOMERS: EPDM
TUBING / FITTINGS: Reinforced Nylon w/ Brass Fittings
CONTROL PILOT(S): Bronze / Brass

Optional at extra charge (consult BEECO):

- Copper Tubing & Brass Fittings
- Stainless Steel Tubing & Fittings
- Complete Stainless Steel Control System

ACV4.00-HF-FLDI1 (SHOWN WITH OPTIONAL STAINLESS STEEL PILOT CONTROL SYSTEM)

 FOR SPEC. SHEETS GO TO www.beecobackflow.com

BEECO -FLDI1 Series On-Off Differential Level Control Valves are designed to control the liquid level in a storage tank or reservoir. It has separate adjustable Opening (Low Level) and Closing (High Level) set-points allowing for optimum water turn-over to avoid stagnation.

FULL PORT HIGH FLOW ELECTRIC ACTUATED VALVES (ANSI 150)

FLANGED BY FLANGED (ANSI 150)				
Model Number	Size	Qty. per Carton	Weight per Carton (Lbs.)	List Price (Each)
ACV1.50-HF-EL	1 1/2"	1	32	\$3,773
ACV2.00-HF-EL	2"	1	32	\$3,773
ACV3.00-HF-EL	3"	1	53	\$6,199
ACV4.00-HF-EL	4"	1	86	\$7,762
ACV6.00-HF-EL	6"	1	180	\$13,591
ACV8.00-HF-EL	8"	1	351	\$24,362
ACV10.00-HF-EL	10"	1	545	\$31,378

FULL PORT HIGH FLOW DIFFERENTIAL LEVEL CONTROL VALVE

FLANGED BY FLANGED (ANSI 150)				
Model Number	Size	Qty. per Carton	Weight per Carton (Lbs.)	List Price (Each)
ACV1.50-HF-FLDI1	1 1/2"	1	32	\$5,891
ACV2.00-HF-FLDI1	2"	1	32	\$5,891
ACV3.00-HF-FLDI1	3"	1	53	\$8,368
ACV4.00-HF-FLDI1	4"	1	86	\$10,372
ACV6.00-HF-FLDI1	6"	1	180	\$15,861
ACV8.00-HF-FLDI1	8"	1	351	\$24,255
ACV10.00-HF-FLDI1	10"	1	545	\$37,191

FULL PORT HIGH FLOW LEVEL CONTROL VALVE ELECTRIC ON/OFF

FLANGED BY FLANGED (ANSI 150)				
Model Number	Size	Qty. per Carton	Weight per Carton (Lbs.)	List Price (Each)
ACV1.50-HF-FLEL	1 1/2"	1	32	\$5,005
ACV2.00-HF-FLEL	2"	1	32	\$5,005
ACV2.50-HF-FLEL	2 1/2"	1	33	\$5,005
ACV3.00-HF-FLEL	3"	1	53	\$6,064
ACV4.00-HF-FLEL	4"	1	86	\$7,816
ACV6.00-HF-FLEL	6"	1	180	\$13,071
ACV8.00-HF-FLEL	8"	1	351	\$17,518
ACV10.00-HF-FLEL	10"	1	545	\$30,319

ACV4.00-HF-FLEL (SHOWN WITH OPTIONAL STAINLESS STEEL PILOT CONTROL SYSTEM)
 FOR SPEC. SHEETS GO TO www.beecobackflow.com

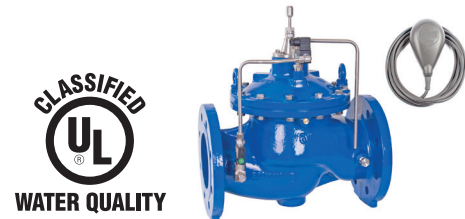

FULL PORT PRESSURE REDUCING AUTOMATIC CONTROL VALVES NSF APPROVED AND MEET THE BUY AMERICA AND PSA REQUIREMENTS

FLANGED BY FLANGED (ANSI 150)				
Model Number	Size	Qty. per Carton	Weight per Carton (Lbs.)	List Price (Each)
ACV2.00-HF-PR-BA	2"	1	45	\$6,156
ACV2.50-HF-PR-BA	2.5"	1	80	\$6,450
ACV3.00-HF-PR-BA	3"	1	85	\$6,363
ACV4.00-HF-PR-BA	4"	1	150	\$7,944
ACV6.00-HF-PR-BA	6"	1	295	\$12,546
ACV8.00-HF-PR-BA	8"	1	585	\$23,378

BEECO -FLEL Series Electric On/Off Level Control Valves open or close fully when the Solenoid is energized by the Electric Float Switch (included). Solenoid enclosure is standard NEMA 4 110-120 VAC.

WORKING PRESSURE: 250 psi
BODY & COVER: Epoxy Coated Ductile Iron
ELASTOMERS: EPDM
TUBING / FITTINGS: Reinforced Nylon w/ Brass Fittings
CONTROL PILOT(S): Bronze / Brass

Optional at extra charge (consult BEECO):
 - Copper Tubing & Brass Fittings
 - Stainless Steel Tubing & Fittings
 - Complete Stainless Steel Control System

FULL PORT PRESSURE REDUCING AUTOMATIC CONTROL VALVES NSF APPROVED AND MEET THE BUY AMERICA AND PSA REQUIREMENTS WITH LOW FLOW BYPASS

FLANGED BY FLANGED (ANSI 150)				
Model Number	Size	Qty. per Carton	Weight per Carton (Lbs.)	List Price (Each)
ACV2.00-HF-LFB-PR-BA	2"	1	55	\$8,071
ACV2.50-HF-LFB-PR-BA	2.5"	1	90	\$8,818
ACV3.00-HF-LFB-PR-BA	3"	1	95	\$9,071
ACV4.00-HF-LFB-PR-BA	4"	1	160	\$10,605

BEECO -PR-BA Series The bypass regulator, typically set 5-10 psi higher than the main valve pilot, controls the pressure under low flow conditions while the main valve remains closed. When the flow capacity of the regulator is exceeded, the pressure drops to the set point of the main valve pilot, causing the main valve to open and provide the higher flow. Response of the main valve is adjusted by an opening speed control.

FOR SPEC. SHEETS GO TO www.beecobackflow.com

REDUCED PORT PRESSURE REDUCING AUTOMATIC CONTROL VALVES NSF APPROVED AND MEET THE BUY AMERICA AND PSA REQUIREMENTS

FLANGED BY FLANGED (ANSI 150)				
Model Number	Size	Qty. per Carton	Weight per Carton (Lbs.)	List Price (Each)
ACV3.00-PR-BA	3"	1	85	\$6,176
ACV4.00-PR-BA	4"	1	145	\$6,430
ACV6.00-PR-BA	6"	1	290	\$9,898
ACV8.00-PR-BA	8"	1	580	\$18,649

"The Beeco ACV is great because you do not need a bypass ... and are very reasonably priced" Frank Paulette,
 - Correct, Mechanical



Distributed by: **MIFAB**

ACV4.00-PR-SSP (SHOWN WITH OPTIONAL STAINLESS STEEL PILOT CONTROL SYSTEM)

FOR SPEC. SHEETS GO TO www.beecobackflow.com



BEECO -SSP Series Pressure Reducing Valves are designed to reduce a fluctuating high upstream pressure to an adjustable constant lower downstream pressure regardless of varying flow demand.

- WORKING PRESSURE:** 250 psi
- BODY & COVER:** Epoxy Coated Ductile Iron
- ELASTOMERS:** EPDM
- TUBING/FITTINGS:** Reinforced Nylon w/ Brass Fittings
- CONTROL PILOT(S):** Bronze / Brass
- Optional at extra charge (consult BEECO):**
 - Copper Tubing & Brass Fittings
 - Stainless Steel Tubing & Fittings
 - Complete Stainless Steel Control System

ACV4.00-PS-SSP (SHOWN WITH OPTIONAL STAINLESS STEEL PILOT CONTROL SYSTEM)

FOR SPEC. SHEETS GO TO www.beecobackflow.com



BEECO -SSP Series Pressure Sustaining Valves are designed to maintain an adjustable minimum upstream pressure, and are normally installed between two pressure zones (Pressure Sustaining Control) or on the discharge side of a pump (Backpressure Control).

- WORKING PRESSURE:** 250 psi
- BODY & COVER:** Epoxy Coated Ductile Iron
- ELASTOMERS:** EPDM
- TUBING / FITTINGS:** Reinforced Nylon w/ Brass Fittings
- CONTROL PILOT(S):** Bronze / Brass
- Optional at extra charge (consult BEECO):**
 - Copper Tubing & Brass Fittings
 - Stainless Steel Tubing & Fittings
 - Complete Stainless Steel Control System

FULL PORT PRESSURE REDUCING AUTOMATIC CONTROL VALVES NSF APPROVED AND MEET THE BUY AMERICA AND PSA REQUIREMENTS WITH LOW FLOW BYPASS

FLANGED BY FLANGED (ANSI 150)				
Model Number	Size	Qty. per Carton	Weight per Carton (Lbs.)	List Price (Each)
ACV2.00-HF-LFB-PR-BA	2"	1	55	\$8,071
ACV2.50-HF-LFB-PR-BA	2.5"	1	90	\$8,818
ACV3.00-HF-LFB-PR-BA	3"	1	95	\$9,071
ACV4.00-HF-LFB-PR-BA	4"	1	160	\$10,605

REDUCED PORT PRESSURE REDUCING

NSF APPROVED STAINLESS STEEL PILOTS

FLANGED BY FLANGED (ANSI 150)				
Model Number	Size	Qty. per Carton	Weight per Carton (Lbs.)	List Price (Each)
ACV3.00-PR-SSP	3"	1	38	\$5,282
ACV4.00-PR-SSP	4"	1	65	\$6,745
ACV6.00-PR-SSP	6"	1	117	\$10,364
ACV8.00-PR-SSP	8"	1	207	\$15,212
ACV10.00-PR-SSP	10"	1	382	\$29,159

REDUCED PORT PRESSURE SUSTAINING

NSF APPROVED STAINLESS STEEL PILOTS

FLANGED BY FLANGED (ANSI 150)				
Model Number	Size	Qty. per Carton	Weight per Carton (Lbs.)	List Price (Each)
ACV3.00-PS-SSP	3"	1	38	\$5,282
ACV4.00-PS-SSP	4"	1	65	\$6,745
ACV6.00-PS-SSP	6"	1	117	\$10,364
ACV8.00-PS-SSP	8"	1	207	\$15,212
ACV10.00-PS-SSP	10"	1	382	\$29,159

FULL PORT PRESSURE REDUCING VALVES

NSF APPROVED STAINLESS STEEL PILOTS

FLANGED BY FLANGED (ANSI 150)				
Model Number	Size	Qty. per Carton	Weight per Carton (Lbs.)	List Price (Each)
ACV1.50-HF-PR-SSP	1 1/2"	1	32	\$4,820
ACV2.00-HF-PR-SSP	2"	1	32	\$4,820
ACV3.00-HF-PR-SSP	3"	1	55	\$7,130
ACV4.00-HF-PR-SSP	4"	1	88	\$9,601
ACV6.00-HF-PR-SSP	6"	1	182	\$15,645
ACV8.00-HF-PR-SSP	8"	1	351	\$28,735
ACV10.00-HF-PR-SSP	10"	1	545	\$35,195

ACV4.00-PR-SSP (SHOWN WITH OPTIONAL STAINLESS STEEL PILOT CONTROL SYSTEM)

FOR SPEC. SHEETS GO TO www.beecobackflow.com



WATER QUALITY



BEECO -SSP Series Pressure Reducing Valves are designed to reduce a fluctuating high upstream pressure to an adjustable constant lower downstream pressure regardless of varying flow demand.

- WORKING PRESSURE:** 250 psi
- BODY & COVER:** Epoxy Coated Ductile Iron
- ELASTOMERS:** EPDM
- TUBING/FITTINGS:** Reinforced Nylon w/ Brass Fittings
- CONTROL PILOT(S):** Bronze / Brass
- Optional at extra charge (consult BEECO):**
 - Copper Tubing & Brass Fittings
 - Stainless Steel Tubing & Fittings
 - Complete Stainless Steel Control System

REDUCED PORT PRESSURE SUSTAINING

NSF APPROVED STAINLESS STEEL PILOTS

FLANGED BY FLANGED (ANSI 150)				
Model Number	Size	Qty. per Carton	Weight per Carton (Lbs.)	List Price (Each)
ACV1.50-HF-PR-SSP	1 1/2"	1	32	\$4,820
ACV2.00-HF-PR-SSP	2"	1	32	\$4,820
ACV3.00-HF-PR-SSP	3"	1	55	\$7,130
ACV4.00-HF-PR-SSP	4"	1	88	\$9,601
ACV6.00-HF-PR-SSP	6"	1	182	\$15,645
ACV8.00-HF-PR-SSP	8"	1	351	\$28,735
ACV10.00-HF-PR-SSP	10"	1	545	\$35,195

ACV4.00-PS-SSP (SHOWN WITH OPTIONAL STAINLESS STEEL PILOT CONTROL SYSTEM)

FOR SPEC. SHEETS GO TO www.beecobackflow.com



WATER QUALITY



BEECO -SSP Series Pressure Sustaining Valves are designed to maintain an adjustable minimum upstream pressure, and are normally installed between two pressure zones (Pressure Sustaining Control) or on the discharge side of a pump (Backpressure Control).

"After installing an ACV the customer called me and said "It was the best ACV PRV that he had ever installed and only wanted Beeco in the Future"

- National Plumbing & Heating Brian, Churilla

ACV4.00-HF5PR (SHOWN WITH STANDARD PILOT CONTROL SYSTEM)

 FOR SPEC. SHEETS GO TO www.beecobackflow.com

BEECO -PR Series Pressure Reducing Valves are designed to reduce a fluctuating high upstream pressure to an adjustable constant lower downstream pressure regardless of varying flow demand.

WORKING PRESSURE: 250 psi
BODY & COVER: Epoxy Coated Ductile Iron
ELASTOMERS: EPDM
TUBING/FITTINGS: Reinforced Nylon w/Brass Fittings
CONTROL PILOT(S): Bronze / Brass

ACV4.00-HF5PS (SHOWN WITH STANDARD PILOT CONTROL SYSTEM)

 FOR SPEC. SHEETS GO TO www.beecobackflow.com

BEECO -PS Series Pressure Sustaining Valves are designed to maintain an adjustable minimum upstream pressure, and are normally installed between two pressure zones (Pressure Sustaining Control) or on the discharge side of a pump (Backpressure Control).

WORKING PRESSURE: 250 psi
BODY & COVER: Epoxy Coated Ductile Iron
ELASTOMERS: EPDM
TUBING/FITTINGS: Reinforced Nylon w/ Brass Fittings
CONTROL PILOT(S): Bronze / Brass

FULL PORT HIGH FLOW PRESSURE REDUCING VALVES 500 SERIES

FLANGED BY FLANGED (ANSI 150)				
Model Number	Size	Qty. per Carton	Weight per Carton (Lbs.)	List Price (Each)
ACV1.50-HF5PR	1 1/2"	1	32	\$3,273
ACV2.00-HF5PR	2"	1	32	\$3,273
ACV2.50-HF5PR	2 1/2"	1	35	\$3,581
ACV3.00-HF5PR	3"	1	55	\$4,620
ACV4.00-HF5PR	4"	1	88	\$5,005
ACV6.00-HF5PR	6"	1	182	\$8,855

FULL PORT HIGH FLOW PRESSURE SUSTAINING VALVES 500 SERIES

FLANGED BY FLANGED (ANSI 150)				
Model Number	Size	Qty. per Carton	Weight per Carton (Lbs.)	List Price (Each)
ACV1.50-HF5PS	1 1/2"	1	32	\$3,273
ACV2.00-HF5PS	2"	1	32	\$3,273
ACV2.50-HF5PS	2 1/2"	1	35	\$3,581
ACV3.00-HF5PS	3"	1	55	\$4,620
ACV4.00-HF5PS	4"	1	88	\$5,005
ACV6.00-HF5PS	6"	1	182	\$8,855

FULL PORT HIGH FLOW ELECTRIC ACTUATED VALVES 500 SERIES

FLANGED BY FLANGED (ANSI 150)				
Model Number	Size	Qty. per Carton	Weight per Carton (Lbs.)	List Price (Each)
ACV1.50-HF5EL	1 1/2"	1	32	\$3,273
ACV2.00-HF5EL	2"	1	32	\$3,273
ACV2.50-HF5EL	2 1/2"	1	35	\$3,581
ACV3.00-HF5EL	3"	1	55	\$4,620
ACV4.00-HF5EL	4"	1	88	\$5,005
ACV6.00-HF5EL	6"	1	182	\$8,855

SEE NOTE BELOW FOR REDUCED PORT				
Model Number	Size	Qty. per Carton	Weight per Carton (Lbs.)	List Price (Each)
ACV2.00-REPAIR-KIT	2"	1	1	\$354
ACV2.50-REPAIR-KIT	2 1/2"	1	2	\$362
ACV3.00-REPAIR-KIT	3"	1	3	\$370
ACV4.00-REPAIR-KIT	4"	1	4	\$370
ACV6.00-REPAIR-KIT	6"	1	5	\$416
ACV8.00-REPAIR-KIT	8"	1	6	\$1,387
ACV10.00-REPAIR-KIT	10"	1	7	\$2,974

For Reduced Port Valves Order One Full Pipe Size Smaller Than Your Full Port Valve.

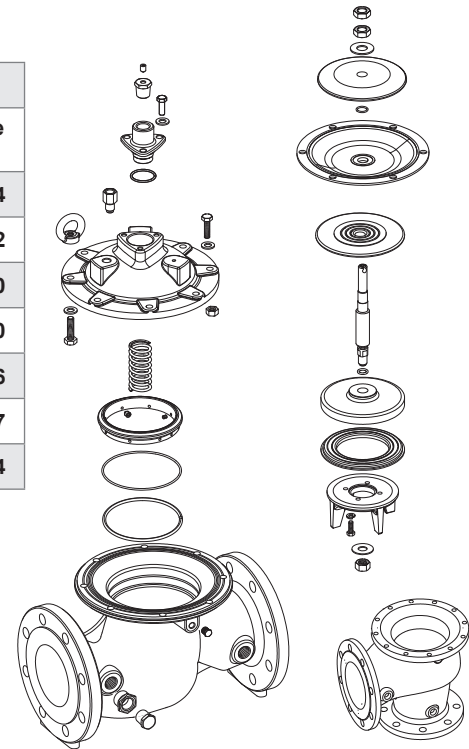

ACV4.00-HF-BASIC (ILLUSTRATED)

"It is nice having a manufacturer like MIFAB that has a broad range of products so that we don't have to go to several different sources. They are a one stop shop."

- Joe Ficek, Grumman Butkus

PRV IRON BODY

FLANGED BY FLANGED AND FEMALE IPS BY FEMALE IPS				
Model Number	Size	Qty. per Carton	Weight per Carton (Lbs.)	List Price (Each)
PRV2.50-FLG	2 1/2"	1	90	\$1,426
PRV2.50-IPS	2 1/2"	1	75	\$1,426
PRV3.00-FLG	3"	1	90	\$1,426
PRV3.00-IPS	3"	1	78	\$1,426

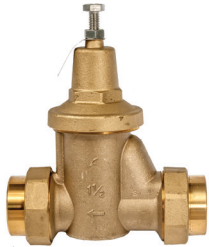

PRV3.00-FLG (ILLUSTRATED)
FOR SPEC. SHEETS GO TO www.beecobackflow.com

METAL CAGE

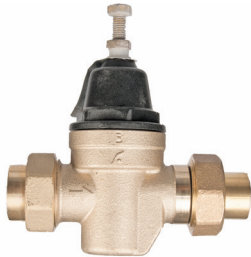
PRV1.50-DU-IPS-C-LL (ILLUSTRATED)

 FOR SPEC. SHEETS GO TO
www.beecobackflow.com
ENGINEERED POLYMER CAGE

PRV.75-DU-IPS-C-LL (ILLUSTRATED)

 FOR SPEC. SHEETS GO TO
www.beecobackflow.com
BODY: Bronze

INTEGRAL STRAINER: Stainless Steel

VALVE DISC: EPDM

SEAT: Replaceable Engineered Polymer

DIAPHRAGM: Reinforced EPDM

TEMPERATURE RANGE:

33 – 180 Degree F (0.5 – 82 Degree C)

WORKING PRESSURE:

300 psi (20.7 bar)

PRESSURE RANGE:

25-75 psi (172-517kPa)

STANDARD PRESSURE SET:

50psi (345 kPa)

APPROVALS:

 Valves are tested and certified to
 A.S.S.E. 1003 (ANSI A.112.26.2),
 listed with I.A.P.M.O. and certified to
 CSA Standard B356.

PRV-C-LL SERIES

 WATER PRESSURE REDUCING VALVES, COMPACT DESIGN WITH
 BYPASS.

DOUBLE UNION, THREADED FEMALE INLET AND OUTLET

Model Number	Size	Qty. per Carton	Weight per Carton (Lbs.)	List Price (Each)
PRV.50-DU-IPS-C-LL	1/2"	24	40	\$109
PRV.75-DU-IPS-C-LL	3/4"	24	40	\$109
PRV1.00-DU-IPS-C-LL	1"	16	36	\$153
PRV1.25-DU-IPS-C-LL	1 1/4"	6	5	\$428
PRV1.50-DU-IPS-C-LL	1 1/2"	6	6	\$476
PRV2.00-DU-IPS-C-LL	2"	6	6	\$550

NOTE: ALL 1/2", 3/4" AND 1" MODELS ARE MANUFACTURED WITH AN ENGINEERED POLYMER CAGE. 1 1/4", 1 1/2" AND 2" MODELS ARE MANUFACTURED WITH A BRONZE CAGE.

DOUBLE UNION, SOLDER UNION INLET AND OUTLET

Model Number	Size	Qty. per Carton	Weight per Carton (Lbs.)	List Price (Each)
PRV.50-DU-SWT-C-LL	1/2"	24	40	\$109
PRV.75-DU-SWT-C-LL	3/4"	24	40	\$109
PRV1.00-DU-SWT-C-LL	1"	16	34	\$153
PRV1.25-DU-SWT-C-LL	1 1/4"	6	5	\$428
PRV1.50-DU-SWT-C-LL	1 1/2"	6	6	\$476
PRV2.00-DU-SWT-C-LL	2"	6	6	\$550

DOUBLE UNION MODEL WITH BOTH UNIONS REMOVED

Model Number	Size	Qty. per Carton	Weight per Carton (Lbs.)	List Price (Each)
PRV1.25-DU-LU-C-LL	1 1/4"	1	5	\$330
PRV1.50-DU-LU-C-LL	1 1/2"	1	6	\$342
PRV2.00-DU-LU-C-LL	2"	1	6	\$415

SINGLE UNION, THREADED FEMALE INLET AND OUTLET

Model Number	Size	Qty. per Carton	Weight per Carton (Lbs.)	List Price (Each)
PRV.50-SU-IPS-C-LL	1/2"	24	36	\$92
PRV.75-SU-IPS-C-LL	3/4"	24	36	\$92
PRV1.00-SU-IPS-C-LL	1"	16	30	\$127

SINGLE UNION, SOLDER UNION INLET AND THREADED FEMALE OUTLET

Model Number	Size	Qty. per Carton	Weight per Carton (Lbs.)	List Price (Each)
PRV.50-SU-SWT-C-LL	1/2"	24	36	\$92
PRV.75-SU-SWT-C-LL	3/4"	24	36	\$92
PRV1.00-SU-SWT-C-LL	1"	16	30	\$127

"The Brass cap is a big plus to some of my customers that do work in the desert communities as sun-UV attack the nylon on your competitors, plumbers have mentioned it is a very cleanly made product with no problems on installation"

- Rob Scott, Owner Action Plumbing Supply

DOUBLE UNION, CPVC FEMALE INLET AND OUTLET

Model Number	Size	Qty. per Carton	Weight per Carton (Lbs.)	List Price (Each)
PRV.50-DU-CPVC-C-LL	1/2"	24	36	\$108
PRV.75-DU-CPVC-C-LL	3/4"	24	36	\$108
PRV1.00-DU-CPVC-C-LL	1"	16	30	\$142

NOTE: ALL 1/2", 3/4" AND 1" MODELS ARE MANUFACTURED WITH AN ENGINEERED POLYMER CAGE. 1 1/4", 1 1/2" AND 2" MODELS ARE MANUFACTURED WITH A BRONZE CAGE.



DOUBLE UNION, PEX INLET AND OUTLET PVC BONNET

Model Number	Size	Qty. per Carton	Weight per Carton (Lbs.)	List Price (Each)
PRV.50-DU-PEX-C-LL	1/2"	24	36	\$108
PRV.75-DU-PEX-C-LL	3/4"	24	36	\$108
PRV1.00-DU-PEX-C-LL	1"	16	30	\$142

COMPONENTS

PRV2.00-DU-IPS-C (ILLUSTRATED)

FOR SPEC. SHEETS GO TO www.beecobackflow.com

COMPONENTS

PRV2.0-DU-IPS-C

BODY: Bronze

INTEGRAL STRAINER: Stainless Steel

VALVE DISC: EPDM

SEAT: Replaceable Engineered Polymer

DIAPHRAGM: Reinforced EPDM

LOW PRESSURE PRV 15PSI TO 75PSI SINGLE UNION IPS

Model Number	Size	Qty. per Carton	Weight per Carton (Lbs.)	List Price (Each)
PRV.50-SU-IPS-LP-LL	1/2"	24	36	\$92
PRV.75-SU-IPS-LP-LL	3/4"	24	36	\$92
PRV1.00-SU-IPS-LP-LL	1"	16	30	\$127

ALSO AVAILABLE IN DU AND IN SWT PLEASE CONSULT FACTORY

PRESSURE: TEMPERATURE DATA:

TEMPERATURE RANGE:

33-180 Deg. F (0.5 Deg. C – 82 Deg. C)

WORKING PRESSURE:

300 psi (2068 kPa)

PRESSURE RANGE:

25-75 psi (172-517kPa)

STANDARD PRESSURE SET:

50psi (345 kPa)

PRV WITH METAL CAGES

Model Number	Size	Qty. per Carton	Weight per Carton (Lbs.)	List Price (Each)
PRV.50-DU-IPS-C-MCLL	1/2"	24	36	\$119
PRV.75-DU-IPS-C-MCLL	3/4"	24	36	\$119
PRV1.0-DU-IPS-C-MCLL	1"	16	30	\$153

ALSO AVAILABLE IN DU AND IN SWT PLEASE CONSULT FACTORY



APPROVALS:

Valves are tested and certified to A.S.S.E. 1003 (ANSI A.112.26.2), listed with I.A.P.M.O. and certified to CSA Standard B356.

PRV1.25-JK-BODY (ILLUSTRATED)

 FOR SPEC. SHEETS GO TO
www.beecobackflow.com

PRV.75-SU-SWT-KIT (ILLUSTRATED)

 FOR SPEC. SHEETS GO TO
www.beecobackflow.com

Jumper Kits are used in new home construction as a temporary by pass. Jumper Kits allow for flushing, testing and cleaning of the piping system. They also deter theft and vandalism on unsecured job sites.

PRV.75-SU-IPS-KIT (ILLUSTRATED)

 FOR SPEC. SHEETS GO TO
www.beecobackflow.com
JK SERIES COMPACT DESIGN ONLY
JUMPER KIT, PLASTIC SPOOL, NO UNION CONNECTIONS

Model Number	Size	Qty. per Carton	Weight per Carton (Lbs.)	List Price (Each)
PRV.50-JK-BODY	1/2" & 3/4"	1	1	\$19
PRV1.00-JK-BODY	1"	1	1	\$24
PRV1.25-JK-BODY	1 1/4"	1	1	\$36
PRV1.50-JK-BODY	1 1/2"	1	1	\$48
PRV2.00-JK-BODY	2"	1	1	\$74

UNION KIT, ONE UNION SOLDER CONNECTION AND ONE FILTER SCREEN

Model Number	Size	Qty. per Carton	Weight per Carton (Lbs.)	List Price (Each)
PRV.50-SU-SWT-LL-KIT	1/2"	1	1	\$12
PRV.75-SU-SWT-LL-KIT	3/4"	1	1	\$12
PRV1.00-SU-SWT-LL-KIT	1"	1	2	\$19
PRV1.25-SU-SWT-LL-UK	1 1/4"	1	2	\$48
PRV1.50-SU-SWT-LL-UK	1 1/2"	1	2	\$48
PRV2.00-SU-SWT-LL-UK	2"	1	3	\$74

UNION KIT, ONE THREADED CONNECTION AND ONE FILTER SCREEN

Model Number	Size	Qty. per Carton	Weight per Carton (Lbs.)	List Price (Each)
PRV.50-SU-IPS-LL-KIT	1/2"	1	1	\$12
PRV.75-SU-IPS-LL-KIT	3/4"	1	1	\$12
PRV1.00-SU-IPS-LL-KIT	1"	1	2	\$19
PRV1.25-SU-IPS-LL-UK	1-1/4"	1	2	\$43
PRV1.50-SU-IPS-LL-UK	1-1/2"	1	2	\$64
PRV2.00-SU-IPS-LL-UK	2"	1	3	\$79

COMPLETELY ASSEMBLED JUMPER KIT (THREADED CONNECTIONS)				
Model Number	Size	Qty. per Carton	Weight per Carton (Lbs.)	List Price (Each)
PRV.50-IPS-JK	1/2"	6	10	\$43
PRV.75-IPS-JK	3/4"	6	12	\$43
PRV1.00-IPS-JK	1"	6	14	\$55
PRV1.25-IPS-JK	1 1/4"	1	16	\$134
PRV1.50-IPS-JK	1 1/2"	1	16	\$176
PRV2.00-IPS-JK	2"	1	16	\$232



PRV.50-SWT-JK (ILLUSTRATED)
FOR SPEC. SHEETS GO TO
www.beecobackflow.com

COMPLETELY ASSEMBLED JUMPER KIT (SWEAT CONNECTIONS)				
Model Number	Size	Qty. per Carton	Weight per Carton (Lbs.)	List Price (Each)
PRV.50-SWT -JK	1/2"	6	10	\$31
PRV.75-SWT -JK	3/4"	6	12	\$32
PRV1.00-SWT -JK	1"	6	14	\$55
PRV1.25-SWT -JK	1 1/4"	1	16	\$134
PRV1.50-SWT -JK	1 1/2"	1	16	\$158
PRV2.00-SWT -JK	2"	1	16	\$232



PRV.50-C-RUBBER-KIT (ILLUSTRATED)
FOR SPEC. SHEETS GO TO
www.beecobackflow.com

PRV REPAIR KITS

RUBBER REPAIR KITS FOR COMPACT MODEL PRV				
Model Number	Size	Qty. per Carton	Weight per Carton (Lbs.)	List Price (Each)
PRV.50-C-RUBBER-KIT	1/2"	1	1	\$36
PRV.75-C-RUBBER-KIT	3/4"	1	1	\$36
PRV1.00-C-RUBBER-KIT	1"	1	1	\$36
PRV1.25-C-RUBBER-KIT	1 1/4"	1	1	\$48
PRV1.50-C-RUBBER-KIT	1 1/2"	1	1	\$48
PRV2.00-C-RUBBER-KIT	2"	1	1	\$48

"BEECO has in stock in local inventory easy to get it, easy to install because come with double union"
- Terry Zhang, L.C. Plumbing & Electrical Supply

RUBBER REPAIR KITS FOR FULL PATTERN MODEL PRV				
Model Number	Size	Qty. per Carton	Weight per Carton (Lbs.)	List Price (Each)
PRV.50-F-RUBBER-KIT	1/2"	1	1	\$36
PRV.75-F-RUBBER-KIT	3/4"	1	1	\$36
PRV1.00-F-RUBBER-KIT	1"	1	1	\$36



PRV1.00-RUBBER-KIT (ILLUSTRATED)
FOR SPEC. SHEETS GO TO
www.beecobackflow.com



PRV1.50-SU-SEAL (ILLUSTRATED)
FOR SPEC. SHEETS GO TO
www.beecobackflow.com

FLAT SEAL FOR UNION CONNECTION

FLAT SEAL FOR UNION CONNECTION				
Model Number	Size	Qty. per Carton	Weight per Carton (Lbs.)	List Price (Each)
PRV1.25-SU-SEAL	1-1/4"	1	1	\$2
PRV1.50-SU-SEAL	1-1/2"	1	1	\$2
PRV2.00-SU-SEAL	2"	1	1	\$4



PRV1.25-SU-IPS-TP (ILLUSTRATED)
FOR SPEC. SHEETS GO TO
www.beecobackflow.com

THREADED UNION CONNECTION

THREADED UNION CONNECTION				
Model Number	Size	Qty. per Carton	Weight per Carton (Lbs.)	List Price (Each)
PRV1.25-SU-IPS-TP	1-1/4"	1	1	\$26
PRV1.50-SU-IPS-TP	1-1/2"	1	1	\$34
PRV2.00-SU-IPS-TP	2"	1	1	\$43



PRV2.00-SU-SWT-TP (ILLUSTRATED)
FOR SPEC. SHEETS GO TO
www.beecobackflow.com

SWEAT UNION CONNECTION

SWEAT UNION CONNECTION				
Model Number	Size	Qty. per Carton	Weight per Carton (Lbs.)	List Price (Each)
PRV1.25-SU-SWT-TP	1-1/4"	1	1	\$24
PRV1.50-SU-SWT-TP	1-1/2"	1	1	\$32
PRV2.00-SU-SWT-TP	2"	1	1	\$35



PRV1.50-SU-IPS-NUT (ILLUSTRATED)
FOR SPEC. SHEETS GO TO
www.beecobackflow.com

UNION NUT

UNION NUT				
Model Number	Size	Qty. per Carton	Weight per Carton (Lbs.)	List Price (Each)
PRV1.25-SU-IPS-NUT	1-1/4"	1	1	\$24
PRV1.50-SU-IPS-NUT	1-1/2"	1	1	\$36
PRV2.00-SU-IPS-NUT	2"	1	1	\$46

PVB SERIES

PRESSURE VACUUM BREAKERS. LOW LEAD AB 1953 COMPLIANT

WITH 1/4 TURN SHUTOFF VALVES

Model Number	Size	Qty. per Carton	Weight per Carton (Lbs.)	List Price (Each)
PVB.50-QT-LL	1/2"	1	3	\$ 209
PVB.75-QT-LL	3/4"	1	4	\$ 224
PVB1.00-QT-LL	1"	1	5	\$ 284
PVB1.25-QT-LL	1 1/4"	1	8	\$ 753
PVB1.50-QT-LL	1 1/2"	1	9	\$ 852
PVB2.00-QT-LL	2"	1	10	\$ 1,031



COMPONENTS

PVB2.00-QT-LL (ILLUSTRATED)

FOR SPEC. SHEETS GO TO www.beecobackflow.com

MAXIMUM WORKING WATER PRESSURE:
150 psi

TEMPERATURE RANGE 33F to 140F
Hydrastatic test pressure to 300 PSI

"I would attribute the majority of our business growth to MIFAB over the last two and a half years which is how long we have worked with them."

- Dan Thomas, Ben Thomas and Associated

DCAV SERIES

**DUAL CHECK VALVE WITH ATMOSPHERIC VENT
(BOILER FEED BACKFLOW VALVE)**

Model Number	Size	Qty. per Carton	Weight per Carton (Lbs.)	List Price (Each)
DCAV.50-NPT	1/2"	1	2	\$ 95
DCAV.75-NPT	3/4"	1	2	\$ 95
DCAV.50-SWT	1/2"	1	2	\$ 95
DCAV.75-SWT	3/4"	1	2	\$ 95
DCAV-KIT	1/2", 3/4"	1	1	\$ 50



COMPONENTS

DCAV.50-NPT (ILLUSTRATED)

FOR SPEC. SHEETS GO TO www.beecobackflow.com

MAXIMUM WORKING WATER PRESSURE:
175 psi (12 Bar)

TEMPERATURE RANGE: 33F to 250F (0.5C to 121C)

Tested and approved to ASSE 1012-2009 and CSA B64.3-11 and IAPMO listed.



APPROVALS:

Valves are tested and certified to A.S.S.E. 1003 (ANSI A.112.26.2), listed with I.A.P.M.O. and certified to CSA Standard B356.

BEECO AIR RELEASE VALVES

Components

No.	Description	Material
1	Body	D.I.
2	Washer	SST
3	Plug	BRS
4	Bottom Guiding Shaft	SST
5	Nut	SST
6	Plate	D.I.
7	Seal	NR
8	Float Body	PE-H.D.
9	Bolt	SST
10	Disc	SST
11	Retaining Ring	SST
12	O-Ring 2-009	NBR
13	Top Guiding Shaft	SST
14	Nozzle	SST
15	Float Cover	PE-H.D.
16	Nozzle Seal	EPDM
17	Guiding Insert	POM
18	Washer	SST
19	Bolt	SST
20	Cover Seal	EPDM
21	Cover	D.I.
22	Bolt	SST
23	Nut	SST
24	I.D. Plate	AL

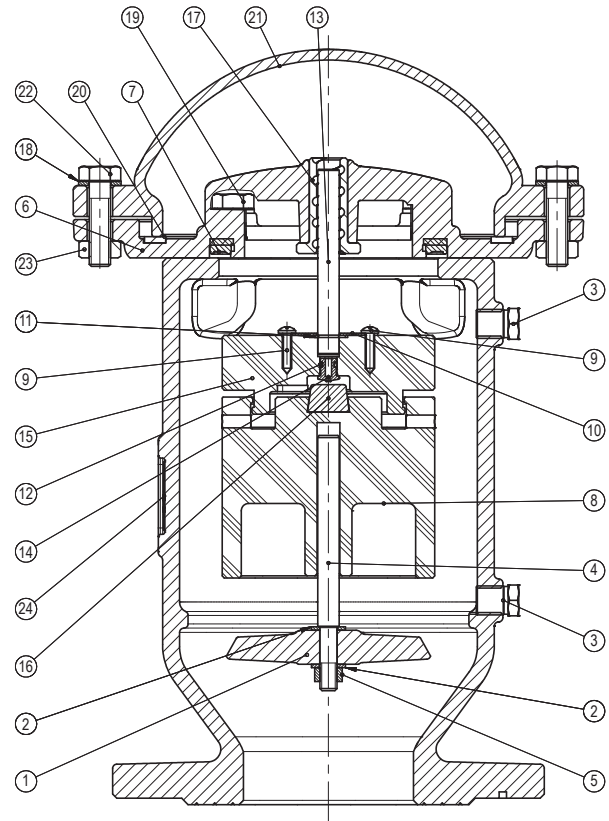

“MIFAB has shown to be the low cost producer in our market. They have done it with improved technology and ease of product components. We have grown our business from \$0 to over \$150,000.00 in less than 3 years.”

- Don Patry, The Tap of Kansas

Model AV-MH-K

Air & Vacuum Valve

Model AV-MH-KA

Combination Air Release and Air & Vacuum Valve

Model AV-MH-KA-SA

Combination Air Release and Air & Vacuum Valve with Surge Arresting Feature

BEECO Air Release Valves are constructed of ductile iron and are 100% coated with an extremely durable high quality electrostatic fusion bonded polymer coating as standard. They are available in 2” through 10” Full Port (-MH) and 3” through 12” Reduced Port (-MS) designs, with both ANSI Class 150 and 300 Flanged (-HP) end connections.

Installed at pipeline high points, functions include Air Release (-A), Air & Vacuum (-K) and Combination Air Release and Air & Vacuum (-KA). An innovative adjustable surge arresting feature (-SA) is available for -KA Models.

BEECO also offers a line of corrosion resistant Plastic Air Release (AV-P-A), Air & Vacuum (AV-P-K) and Combination Air Release and Air & Vacuum (AV-P-KA) Valves in sizes 1/2” through 2” MNPT.

PURPOSE:

VENTING AIR FROM A FILLING PIPELINE

The standard valve allows the discharge of large volumes of air while the system is being filled with liquid, preventing water hammer. The valve remains open, even at very high air flow velocity (Fig. A), until the liquid reaches the float lifting it to the closed position (Fig. B).

VACUUM BREAKING (AIR INTAKE) OF A DRAINING PIPELINE

A decrease in system pressure to a negative value and the simultaneous drainage of the valve chamber causes the float to drop, allowing the admittance of air into the pipeline preventing negative pressure from causing potential pipeline collapse (Fig. C).

This function is available in Models with suffix -K and -KA.

RELEASE OF DISSOLVED AIR FROM A PRESSURIZED PIPELINE

Air that is released from liquid in a pressurized system, or is introduced into the system from open sources and/or pumping vortexes, reduces system efficiency and causes water hammer. Air Release Valves installed at system high points allow air to accumulate in the valve chamber.

The accumulated air forces the liquid out of the valve chamber, reducing the upward force on the Bottom Float. As the Bottom Float drops, trapped air is vented through the small Nozzle in the center of the Top Float. As the liquid returns into the valve chamber the Bottom Float is lifted, sealing the Nozzle (Fig. D).

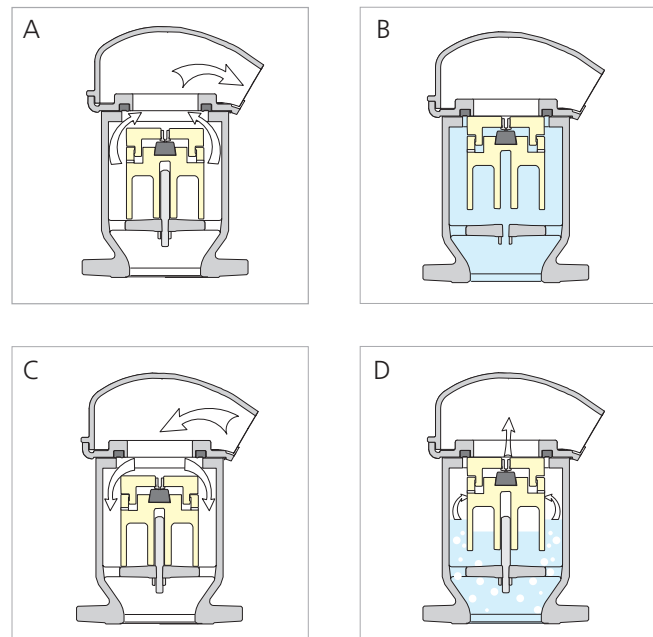

This function is available in Models with suffix -A and -KA only.

ADJUSTABLE SURGE ARRESTING FEATURE

BEECO MH and MS Series Combination Air Release and Air & Vacuum Valves (-KA) can be fitted with a unique, adjustable, surge arresting feature (-SA). As air is exhausted from the pipeline, the optional (-SA) surge arresting feature limits the air outflow when the velocity exceeds the adjustable limit. This feature creates a temporary slow closing “air cushion”, controlling potentially damaging water hammer in the pipeline.

AV4.00-MH-K (ILLUSTRATED)

 FOR SPEC. SHEETS GO TO
www.beecobackflow.com

BEECO AV-MH-K Air & Vacuum Valves allow the discharge of large volumes of air while the pipeline is being filled preventing water hammer, and the admittance of air, preventing damaging negative pressure, while the system is being drained.

BEECO AV-MH-KA Combination Air Release and Air & Vacuum Valves allow the discharge of large volumes of air while the pipeline is being filled, the admittance of air while the system is being drained, and vents air that accumulates while the pipeline is pressurized.

“MIFAB commercial plumbing products have you covered so nothing you need slips through your hands.”

- Richard Aliff, Plumbing Engineer, BNK Engineering, Raleigh, NC

AV4.00-MH-KA-SA (ILLUSTRATED)

 FOR SPEC. SHEETS GO TO
www.beecobackflow.com

BEECO Model AV-MH-KA-SA Valves perform all the functions of the AV-MH-KA, and include a unique patented Surge Arresting Feature (-SA). This feature limits air outflow when the velocity exceeds the adjustable limit, creating an “Air Cushion” to control potentially damaging water hammer.

AIR RELEASE VALVES MH SERIES
HIGH FLOW AIR & VACUUM VALVE (ANSI 150)

Model Number	Size	Qty. per Carton	Weight per Carton (Lbs.)	List Price (Each)
AV2.00-MH-K	2"	1	17	\$1,425
AV3.00-MH-K	3"	1	27	\$2,233
AV4.00-MH-K	4"	1	57	\$3,003
AV6.00-MH-K	6"	1	115	\$6,237
AV8.00-MH-K	8"	1	192	\$9,511
AV10.00-MH-K	10"	1	478	\$12,860

HIGH FLOW COMBINATION VALVE (ANSI 150)

Model Number	Size	Qty. per Carton	Weight per Carton (Lbs.)	List Price (Each)
AV2.00-MH-KA	2"	1	17	\$1,694
AV3.00-MH-KA	3"	1	27	\$2,618
AV4.00-MH-KA	4"	1	57	\$3,427
AV6.00-MH-KA	6"	1	115	\$6,742
AV8.00-MH-KA	8"	1	192	\$10,010
AV10.00-MH-KA	10"	1	478	\$14,399

HIGH FLOW COMBINATION VALVE WITH SURGE ARRESTING FEATURE (ANSI 150)

Model Number	Size	Qty. per Carton	Weight per Carton (Lbs.)	List Price (Each)
AV2.00-MH-KA-SA	2"	1	17	\$2,580
AV3.00-MH-KA-SA	3"	1	27	\$3,889
AV4.00-MH-KA-SA	4"	1	57	\$5,006
AV6.00-MH-KA-SA	6"	1	115	\$8,663
AV8.00-MH-KA-SA	8"	1	192	\$13,475
AV10.00-MH-KA-SA	10"	1	478	\$21,715

AIR RELEASE VALVES MS SERIES
REDUCED PORT AIR & VACUUM VALVE (ANSI 150)

Model Number	Size	Qty. per Carton	Weight per Carton (Lbs.)	List Price (Each)
AV3.00-MS-K	3"	1	20	\$1,463
AV4.00-MS-K	4"	1	31	\$2,233
AV6.00-MS-K	6"	1	68	\$3,157
AV8.00-MS-K	8"	1	125	\$6,392
AV10.00-MS-K	10"	1	273	\$9,009
AV12.00-MS-K	12"	1	467	\$14,554

REDUCED PORT COMBINATION VALVE (ANSI 150)

Model Number	Size	Qty. per Carton	Weight per Carton (Lbs.)	List Price (Each)
AV3.00-MS-KA	3"	1	20	\$1,810
AV4.00-MS-KA	4"	1	31	\$2,580
AV6.00-MS-KA	6"	1	68	\$3,812
AV8.00-MS-KA	8"	1	125	\$7,392
AV10.00-MS-KA	10"	1	273	\$9,511
AV12.00-MS-KA	12"	1	467	\$15,170

REDUCED PORT COMBINATION VALVE WITH SURGE ARRESTING FEATURE (ANSI 150)

Model Number	Size	Qty. per Carton	Weight per Carton (Lbs.)	List Price (Each)
AV3.00-MS-KA-SA	3"	1	20	\$2,618
AV4.00-MS-KA-SA	4"	1	31	\$3,812
AV6.00-MS-KA-SA	6"	1	68	\$5,313
AV8.00-MS-KA-SA	8"	1	125	\$9,240
AV10.00-MS-KA-SA	10"	1	273	\$12,782
AV12.00-MS-KA-SA	12"	1	467	\$22,485

AIR RELEASE VALVES HP SERIES

HIGH FLOW AIR & VACUUM VALVE (ANSI 300)

Model Number	Size	Qty. per Carton	Weight per Carton (Lbs.)	List Price (Each)
AV2.00-MH-K-HP	2"	1	17	\$1,781
AV3.00-MH-K-HP	3"	1	27	\$2,792
AV4.00-MH-K-HP	4"	1	57	\$3,754
AV6.00-MH-K-HP	6"	1	115	\$7,797
AV8.00-MH-K-HP	8"	1	192	\$11,888
AV10.00-MH-K-HP	10"	1	478	\$16,074

HIGH FLOW COMBINATION VALVE (ANSI 300)

Model Number	Size	Qty. per Carton	Weight per Carton (Lbs.)	List Price (Each)
AV2.00-MH-KA-HP	2"	1	17	\$2,118
AV3.00-MH-KA-HP	3"	1	27	\$3,273
AV4.00-MH-KA-HP	4"	1	57	\$4,283
AV6.00-MH-KA-HP	6"	1	115	\$8,423
AV8.00-MH-KA-HP	8"	1	192	\$12,514
AV10.00-MH-KA-HP	10"	1	478	\$17,999

BEECO AV-MS-KA Combination Air Release and Air & Vacuum Valves allow the discharge of large volumes of air while the pipeline is being filled, the admittance of air while the system is being drained, and vents air that accumulates while the pipeline is pressurized.

FOR SPEC. SHEETS GO TO www.beecobackflow.com



BEECO Model AV-MS-KA-SA Valves perform all the functions of the AV-MS-KA, and include a unique patented Surge Arresting Feature (-SA). This feature limits air outflow when the velocity exceeds the adjustable limit, creating an "air cushion" to control potentially damaging water hammer.

FOR SPEC. SHEETS GO TO www.beecobackflow.com

BEECO AV-MH-K-HP Air & Vacuum Valves allow the discharge of large volumes of air while the pipeline is being filled preventing water hammer, and the admittance of air, preventing damaging negative pressure, while the system is being drained.

FOR SPEC. SHEETS GO TO www.beecobackflow.com



BEECO AV-MH-KA-HP Combination Air Release and Air & Vacuum Valves allow the discharge of large volumes of air while the pipeline is being filled, the admittance of air while the system is being drained, and vents air that accumulates while the pipeline is pressurized.

FOR SPEC. SHEETS GO TO www.beecobackflow.com



Distributed by: **MIFAB**



BEECO Model AV-MH-KA-SA-HP Valves perform all the functions of the AV-MH-KA-HP, and include a unique patented Surge Arresting Feature (-SA). This feature limits air outflow when the velocity exceeds the adjustable limit, creating an “air cushion” to control potentially damaging water hammer.

FOR SPEC. SHEETS GO TO
www.beecobackflow.com

BEECO AV-MS-K-HP Air & Vacuum Valves allow the discharge of large volumes of air while the pipeline is being filled preventing water hammer, and the admittance of air, preventing damaging negative pressure, while the system is being drained.

FOR SPEC. SHEETS GO TO
www.beecobackflow.com

BEECO AV-MS-KA-HP Combination Air Release and Air & Vacuum Valves allow the discharge of large volumes of air while the pipeline is being filled, the admittance of air while the system is being drained, and vents air that accumulates while the pipeline is pressurized.

FOR SPEC. SHEETS GO TO
www.beecobackflow.com

“The people at MIFAB are great and they will help you the best they can.”

- Dan Thomas of Ben Thomas and Associates, Shade Gap, PA

HIGH FLOW COMBINATION VALVE WITH SURGE ARRESTING FEATURE (ANSI 300)

Model Number	Size	Qty. per Carton	Weight per Carton (Lbs.)	List Price (Each)
AV2.00-MH-KA-SA-HP	2"	1	17	\$3,225
AV3.00-MH-KA-SA-HP	3"	1	27	\$4,861
AV4.00-MH-KA-SA-HP	4"	1	57	\$6,257
AV6.00-MH-KA-SA-HP	6"	1	115	\$10,828
AV8.00-MH-KA-SA-HP	8"	1	192	\$16,844
AV10.00-MH-KA-SA-HP	10"	1	478	\$27,144

REDUCED PORT AIR & VACUUM VALVE (ANSI 300)

Model Number	Size	Qty. per Carton	Weight per Carton (Lbs.)	List Price (Each)
AV3.00-MS-K-HP	3"	1	20	\$1,828
AV4.00-MS-K-HP	4"	1	31	\$2,792
AV6.00-MS-K-HP	6"	1	68	\$3,947
AV8.00-MS-K-HP	8"	1	125	\$7,989
AV10.00-MS-K-HP	10"	1	273	\$11,262
AV12.00-MS-K-HP	12"	1	467	\$18,193

REDUCED PORT COMBINATION VALVE (ANSI 300)

Model Number	Size	Qty. per Carton	Weight per Carton (Lbs.)	List Price (Each)
AV3.00-MS-KA-HP	3"	1	20	\$2,262
AV4.00-MS-KA-HP	4"	1	31	\$3,225
AV6.00-MS-KA-HP	6"	1	68	\$4,764
AV8.00-MS-KA-HP	8"	1	125	\$9,24
AV10.00-MS-KA-HP	10"	1	273	\$11,888
AV12.00-MS-KA-HP	12"	1	467	\$18,962

REDUCED PORT COMBINATION VALVE WITH SURGE ARRESTING FEATURE (ANSI 300)

Model Number	Size	Qty. per Carton	Weight per Carton (Lbs.)	List Price (Each)
AV3.00-MS-KA-SA-HP	3"	1	20	\$3,273
AV4.00-MS-KA-SA-HP	4"	1	31	\$4,764
AV6.00-MS-KA-SA-HP	6"	1	68	\$6,642
AV8.00-MS-KA-SA-HP	8"	1	125	\$11,551
AV10.00-MS-KA-SA-HP	10"	1	273	\$15,979
AV12.00-MS-KA-SA-HP	12"	1	467	\$28,107

AIR RELEASE VALVES PLASTIC SERIES

AIR RELEASE VALVE				
Model Number	Size	Qty. per Carton	Weight per Carton (Lbs.)	List Price (Each)
AV.50-P-A	1/2"	25	20	\$ 460
AV.75-P-A	3/4"	25	20	\$ 460
AV1.00-P-A	1"	25	20	\$ 460

AIR & VACUUM VALVE				
Model Number	Size	Qty. per Carton	Weight per Carton (Lbs.)	List Price (Each)
AV.50-P-K	1/2"	25	20	\$ 460
AV.75-P-K	3/4"	25	20	\$ 460
AV1.00-P-K	1"	20	16	\$ 460
AV2.00-P-K	2"	8	16	\$ 660

COMBINATION AIR RELEASE AND AIR & VACUUM VALVE				
Model Number	Size	Qty. per Carton	Weight per Carton (Lbs.)	List Price (Each)
AV.50-P-KA	1/2"	25	20	\$ 460
AV.75-P-KA	3/4"	25	20	\$ 460
AV1.00-P-KA	1"	20	16	\$ 460
AV2.00-P-KA	2"	8	16	\$ 660



AV1.00-P-A (ILLUSTRATED)
FOR SPEC. SHEETS GO TO www.beecobackflow.com

BEECO AV-P-A Air Release Valves release small amounts of air that accumulate in high points while the pipeline remains pressurized.



AV.75-P-K (ILLUSTRATED)
FOR SPEC. SHEETS GO TO www.beecobackflow.com

BEECO AV-P-K Air & Vacuum Valves allow the discharge of large volumes of air while the pipeline is being filled preventing water hammer, and the admittance of air, preventing damaging negative pressure, while the system is being drained.



AV2.00-P-KA (ILLUSTRATED)
FOR SPEC. SHEETS GO TO www.beecobackflow.com

BEECO AV-P-KA Combination Air Release and Air & Vacuum Valves allow the discharge of large volumes of air while the pipeline is being filled, the admittance of air while the system is being drained, and vents small amounts of air that accumulate while the pipeline is pressurized.

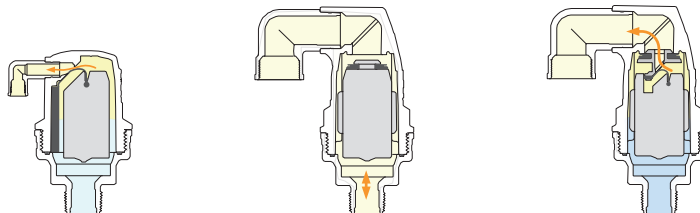

AIR RELEASE VALVE

AIR AND VACUUM VALVE

COMBINATION AIR VALVE

“The Beeco Plastic Air Valves provide dependable service at a competitive price, without the weight and corrosion concerns associated with metal valves.”

- William Dozier, CEO Pioneer Supply Moore, OK

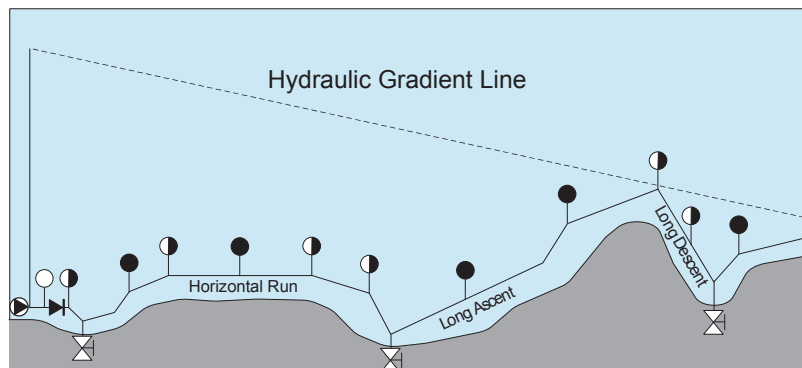

- Air and Vacuum Valve
- Air Release Valve
- ◐ Combination Air Valve
- ⦿ Pump
- ▶ Check Valve
- ⊗ Drain Valve
- Reservoir



AV4.00-WP-KA-CS-FL (ILLUSTRATED)
FOR SPEC. SHEETS GO TO
www.beecobackflow.com



AV4.00-WP-KA-SS-FL (ILLUSTRATED)
FOR SPEC. SHEETS GO TO
www.beecobackflow.com

AIR RELEASE VALVES WP SERIES

SEWAGE AIR RELEASE VALVES COATED STEEL BODY

Model Number	Size	Qty. per Carton	Weight per Carton (Lbs.)	List Price (Each)
AV2.00-WP-KA-CS-TH	2" IPS	1	28	\$ 4,598
AV2.00-WP-KA-CS-FL	2" FLANGED	1	33	\$ 4,836
AV3.00-WP-KA-CS-FL	3" FLANGED	1	33	\$ 5,136
AV4.00-WP-KA-CS-FL	4" FLANGED	1	40	\$ 5,420
AV6.00-WP-KA-CS-FL	6" FLANGED	1	49	\$ 5,879

SEWAGE AIR RELEASE VALVES STAINLESS STEEL BODY

Model Number	Size	Qty. per Carton	Weight per Carton (Lbs.)	List Price (Each)
AV2.00-WP-KA-SS-TH	2" IPS	1	27	\$ 6,806
AV2.00-WP-KA-SS-FL	2" FLANGED	1	28	\$ 7,490
AV3.00-WP-KA-SS-FL	3" FLANGED	1	33	\$ 7,840
AV4.00-WP-KA-SS-FL	4" FLANGED	1	40	\$ 8,344
AV6.00-WP-KA-SS-FL	6" FLANGED	1	49	\$ 8,821

Designed especially designed for Wastewater Systems, BEECO Models AV-WP-KA-SS and AV-WP-KA-CS Combination Air Release and Air & Vacuum Valves allow the discharge of large volumes of air while the pipeline is being filled preventing water hammer, and the admittance of air, preventing damaging negative pressure, when the system is drained. The valves also vent trapped air and gases that accumulate while the pipeline is pressurized.

The specially designed conical inlet reduces fluid velocity, also preventing water hammer. The extended body design lowers the Float, allowing the valve to efficiently operate while keeping fluid and suspended solids from fouling sealing mechanisms and avoiding atmospheric spillage. Valves are equipped with a side-mounted 1" NPT Stainless Steel Isolation Ball Valve for draining and flushing operations.

Components

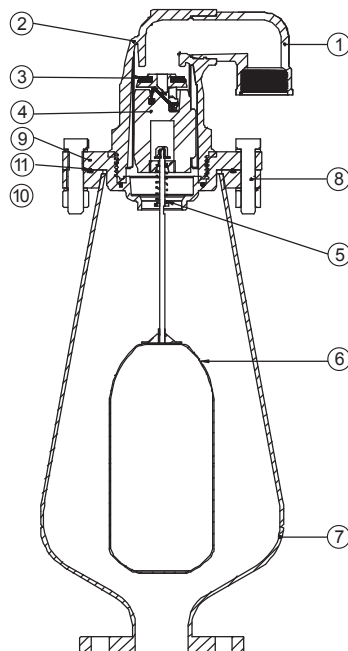

No	Description	Material
1	Bonnet elbow	PP
2	Bonnet	GRP
3	Seals	EPDM
4	Top Float	Foam PP
5	Spring	SS302
6	Main Float Sub. Assy.	SS316
7	Body	ST-37* or 316L SS
8	Bolt	SS316
9	Adapter Flange	PA
10	O Ring	NBR
11	O Ring	NBR

Three layer, UV protected epoxy coating *

BEECO FRIENDLY DOUBLE CHECK BACKFLOW PREVENTERS

"MIFAB's plant is huge and they always have everything ready and available for us."
- Dan Thomas of Ben Thomas and Associates, Shade Gap, PA

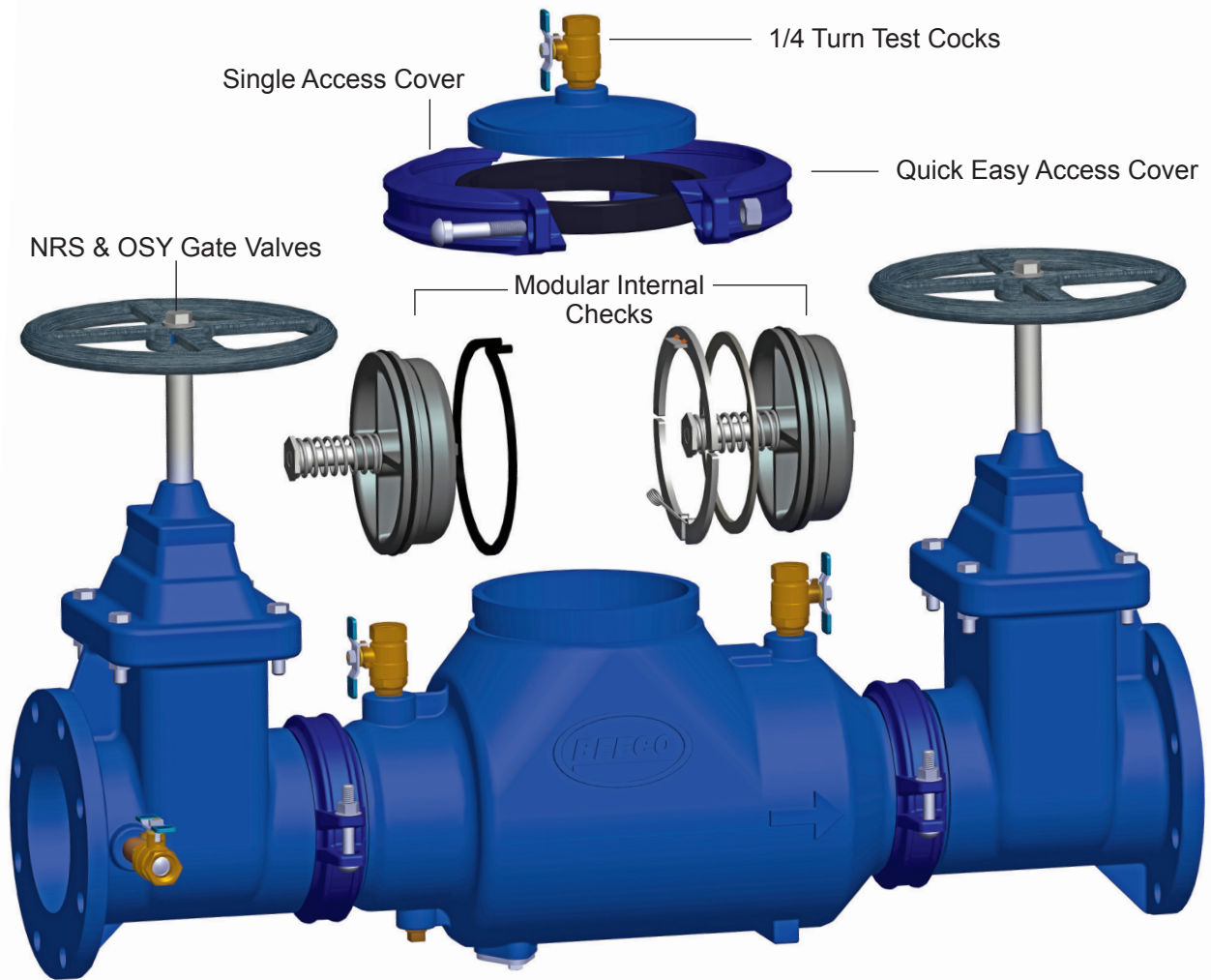

USC
APPROVED

2 1/2" thru 8"

Fusion Bonded Epoxy Coating



Distributed by: MIFAB®

PURPOSE:

The BEECO FDC is designed to eliminate contamination from cross connections in a potable water system. A cross connection is any physical connection between two separate systems, one of which contains drinking water and the other polluted or contaminated fluids, chemicals or sewage. Contaminated water may flow through cross connections and between connected systems as the direction of flow can reverse depending on the pressure differential of each system. The BEECO Double Check Valve is designed to protect against both backpressure and back-siphonage.

SIZING AND INSTALLATION GUIDE:

The BEECO Double Check Valve is made to fit all standard pipe sizes from a 1/2" supply line up to a 10" main supply line. These valves can be installed in either indoor or outdoor applications but need to be protected against freezing in cold weather climates. All backflow devices must be installed by a licensed plumbing professional and must be installed to your local and state plumbing codes. All Double Check valves must be retested each year by a trained licensed backflow specialist.

HOW IT WORKS:

A simple method of protecting your potable water supply without the need to re-establish pressure by means of pumps or towers, is the use of a double check valve. The BEECO Double Check Valve comes with two internal checks. These checks are spring loaded and open and allow water to pass through the direction of flow when the water pressure reaches 4 PSI or higher, and the checks stay open as long as there is flow and pressure in the normal direction of flow. Should a backpressure or back-siphonage occur in the system causing reverse direction in water flow both check valves will close, preventing contamination of your water supply.

FEATURES AND BENEFITS:

The new modern redesigned BEECO Friendly Double Check Valve was designed with input from hundreds of plumbers, and many backflow specialists were involved. It was designed with ease of access and a dramatic reduction in the spare parts needed. The light weight short lay length modular design makes this valve the easiest and quickest valve to perform your mandatory yearly certification on. For a complete list of all our features and benefits, see our website: www.beecobackflow.com. The BEECO Double Check Valve is available with a detector check bypass and flow meter used on fire lines. See the DCDA product offering.

FDC (SMALL)

DOUBLE CHECK BACKFLOW PREVENTER, BRONZE BODY

WITH 1/4 TURN SHUTOFF VALVES

Model Number	Size	Qty. per Carton	Weight per Carton (Lbs.)	List Price (Each)
FDC.50-QT-LL	1/2"	1	4	\$278
FDC.75-QT-LL	3/4"	1	4.5	\$315
FDC1.00-QT-LL	1"	1	6.4	\$460
FDC1.25-QT-LL	1 1/4"	1	10	\$805
FDC1.50-QT-LL	1 1/2"	1	12	\$945
FDC2.00-QT-LL	2"	1	19	\$1,476

WITH 1/4 TURN SHUTOFF AND LOCKING HANDLES

Model Number	Size	Qty. per Carton	Weight per Carton (Lbs.)	List Price (Each)
FDC.50-QT-LH-LL	1/2"	1	4	\$306
FDC.75-QT-LH-LL	3/4"	1	4.5	\$347
FDC1.00-QT-LH-LL	1"	1	6.4	\$506
FDC1.25-QT-LH-LL	1 1/4"	1	10	\$886
FDC1.50-QT-LH-LL	1 1/2"	1	12	\$1,040
FDC2.00-QT-LH-LL	2"	1	19	\$1,624

WITH 1/4 TURN SHUTOFFS AND STAINLESS STEEL HANDLES

Model Number	Size	Qty. per Carton	Weight per Carton (Lbs.)	List Price (Each)
FDC.50-QT-SH-LL	1/2"	1	4	\$306
FDC.75-QT-SH-LL	3/4"	1	4.5	\$347
FDC1.00-QT-SH-LL	1"	1	6.4	\$506
FDC1.25-QT-SH-LL	1 1/4"	1	10	\$886
FDC1.50-QT-SH-LL	1 1/2"	1	12	\$1,040
FDC2.00-QT-SH-LL	2"	1	19	\$1,624

WITH 1/4 TURN SHUTOFF AND WYE TYPE STRAINER

Model Number	Size	Qty. per Carton	Weight per Carton (Lbs.)	List Price (Each)
FDC.50-QT-S-LL	1/2"	1	4.9	\$305
FDC.75-QT-S-LL	3/4"	1	5.3	\$356
FDC1.00-QT-S-LL	1"	1	7.5	\$527
FDC1.25-QT-S-LL	1 1/4"	1	11.5	\$903
FDC1.50-QT-S-LL	1 1/2"	1	14	\$1,086
FDC2.00-QT-S-LL	2"	1	22	\$1,703

BEECO FDC-Low Lead Series is produced with a maximum .25% lead by volume and meets all current no lead requirements



FDC.75-QT-LL (ILLUSTRATED)

FOR SPEC. SHEETS GO TO www.beecobackflow.com

"No kidding? I was always under the impression that siphonic typically required more ponding than roof drains would usually incur. That is really good to know!"

- Kyle M. Jones, EIT, Mechanical Engineer, SOLUTIONS AEC, St. Louis, Missouri



APPROVALS:

Tested and certified to A.S.S.E. Standard 1015, CSA B64.5 and listed with IAPMO.

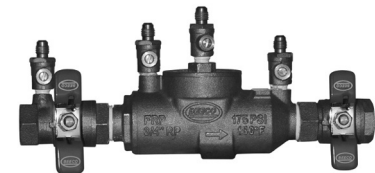

FDC.75-QT-SH-LL (ILLUSTRATED)

FOR SPEC. SHEETS GO TO www.beecobackflow.com

Double Check Backflow Preventers are designed to protect against contamination of potable water.

Installation and selection of the proper device should be made by a qualified licensed professional.

All Low Lead Models are compliant with CA 1953 and VT S.152 lead laws.



FDC.75-QT-S-LL (ILLUSTRATED)

FOR SPEC. SHEETS GO TO www.beecobackflow.com

BEECO Double Check Backflow Preventers are designed to protect against contamination of potable water.

Installation and selection of the proper device should be made by a qualified licensed professional.

The BEECO FDC Series is certified and tested to ASSE 1015, CSA B64.5 and listed with IAPMO.

All devices are AWWA compliant.



FDC4.00-NRS (ILLUSTRATED)

FOR SPEC. SHEETS GO TO www.beecobackflow.com



FDC3.00-OSY (ILLUSTRATED)

FOR SPEC. SHEETS GO TO www.beecobackflow.com



APPROVALS:

Tested and certified to A.S.S.E. Standard 1015, AWWA Compliant C510 (with gates only), CSA B64.5 and listed with IAPMO.

"The product we have sold is well built.. I have no call backs on the units that we have in the field at Ft. Indiantown Gap Army Depot and the catalog is an easy read to find the product"

- Dave Roberts, Maryland Pipe & Supply

FDC (LARGE)

DOUBLE CHECK BACKFLOW PREVENTER

WITH DUCTILE IRON SHUTOFFS AND NO LEADED COMPONENTS WITH NRS RESILIENT SEATED SHUTOFF VALVES AND FLANGED CONNECTIONS

Model Number	Size	Qty. per Carton	Weight per Carton (Lbs.)	List Price (Each)
FDC2.50-NRS	2 1/2"	1	183	\$3,738
FDC3.00-NRS	3"	1	200	\$3,881
FDC4.00-NRS	4"	1	222	\$4,418
FDC6.00-NRS	6"	1	380	\$6,847
FDC8.00-NRS	8"	1	900	\$18,908
FDC10.00-NRS	10"	1	1170	\$22,774

WITH OSY RESILIENT SEATED SHUTOFF VALVES AND FLANGED CONNECTIONS

Model Number	Size	Qty. per Carton	Weight per Carton (Lbs.)	List Price (Each)
FDC2.50-OSY	2 1/2"	1	191	\$4,009
FDC3.00-OSY	3"	1	206	\$4,060
FDC4.00-OSY	4"	1	237	\$4,596
FDC6.00-OSY	6"	1	386	\$6,959
FDC8.00-OSY	8"	1	950	\$19,918
FDC10.00-OSY	10"	1	1270	\$23,784

NRS RESILIENT SEATED SHUTOFF VALVES, FLANGED CONNECTIONS COMPLIES WITH THE BUY AMERICA ACT AND THE PENNSYLVANIA STEEL ACT

Model Number	Size	Qty. per Carton	Weight per Carton (Lbs.)	List Price (Each)
FDC2.50-NRS-BA	2 1/2"	1	183	P.O.A.
FDC3.00-NRS-BA	3"	1	200	P.O.A.
FDC4.00-NRS-BA	4"	1	222	P.O.A.
FDC6.00-NRS-BA	6"	1	380	P.O.A.
FDC8.00-NRS-BA	8"	1	900	P.O.A.
FDC10.00-NRS-BA	10"	1	1170	P.O.A.

OSY RESILIENT SEATED SHUTOFF VALVES, FLANGED CONNECTIONS IS UL LISTED AND APPROVED

Model Number	Size	Qty. per Carton	Weight per Carton (Lbs.)	List Price (Each)
FDC2.50-OSY-UL	2 1/2"	1	191	\$3,932
FDC3.00-OSY-UL	3"	1	206	\$3,983
FDC4.00-OSY-UL	4"	1	237	\$4,508
FDC6.00-OSY-UL	6"	1	386	\$6,827
FDC8.00-OSY-UL	8"	1	950	\$19,538
FDC10.00-OSY-UL	10"	1	1270	\$23,330



APPROVALS:

Tested and certified to A.S.S.E. Standard 1015, AWWA Compliant C510 (with gates only), CSA B64.5 and listed with IAPMO. Valves are tested and listed to UL

BEECO Double Check Backflow Preventers are designed to protect against contamination of potable water.

Installation and selection of the proper device should be made by a qualified licensed professional.

The BEECO FDC Series is certified and tested to ASSE 1015, CSA B64.5 and listed with IAPMO.

All devices are AWWA compliant.

WITH NRS RESILIENT SEATED SHUTOFF VALVES, FLANGED WITH A STRAINER

Model Number	Size	Qty. per Carton	Weight per Carton (Lbs.)	List Price (Each)
FDC2.50-NRS-S	2 1/2"	1	219	\$4,112
FDC3.00-NRS-S	3"	1	243	\$4,385
FDC4.00-NRS-S	4"	1	290	\$5,014
FDC6.00-NRS-S	6"	1	540	\$8,190
FDC8.00-NRS-S	8"	1	1175	\$20,924
FDC10.00-NRS-S	10"	1	1580	\$26,132



FDC3.00-OSY (ILLUSTRATED)

FOR SPEC. SHEETS GO TO www.beecobackflow.com



2 1/2" thru 6"

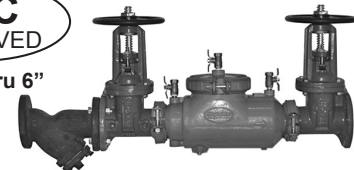

FDC4.00-OSY-S (ILLUSTRATED)

FOR SPEC. SHEETS GO TO www.beecobackflow.com

WITH OSY RESILIENT SEATED SHUTOFF VALVES, FLANGED WITH A STRAINER

Model Number	Size	Qty. per Carton	Weight per Carton (Lbs.)	List Price (Each)
FDC2.50-OSY-S	2 1/2"	1	227	\$4,381
FDC3.00-OSY-S	3"	1	249	\$4,561
FDC4.00-OSY-S	4"	1	305	\$5,190
FDC6.00-OSY-S	6"	1	546	\$8,299
FDC8.00-OSY-S	8"	1	1225	\$21,924
FDC10.00-OSY-S	10"	1	1680	\$27,132



2 1/2" thru 6"



FDC3.00-OSY-G (ILLUSTRATED)

FOR SPEC. SHEETS GO TO www.beecobackflow.com



Distributed by: **MIFAB**

BEECO Double Check Backflow Prevention Devices are designed to protect against contamination of potable water. Installation and selection of the proper device should be made by a qualified licensed professional.



FDC3.00-NRS-G-BA (ILLUSTRATED)

FOR SPEC. SHEETS GO TO

WWW.BEECOBACKFLOW.COM

SPECIFICATION: The BEECO Friendly Double Check Backflow Preventer Valve is designed to stop the reverse of flow of a liquid into a potable water system. The proper installation of a backflow preventer must be done by a certified expert under local codes and guidelines to assure the protection of the drinking water system. The valve is certified to ASSE 1015, CSA B64.5 and listed with IAPMO.

FUNCTION: The assembly shall consist of two repairable positive seating check modules with captured springs and rubber seat discs. Service of all internal components shall be through a single easily removable cover and designed for ease of access.

"Beeco is a worry free alternative for all my backflow needs"

- John Marotta, Ridge Plumbing



APPROVALS:

Tested and certified to A.S.S.E. Standard 1015, AWWA Compliant C510 (with gates only), CSA B64.5 and listed with IAPMO. Valves are tested and listed to UL

DOUBLE CHECK BACKFLOW PREVENTER

WITH GROOVED CONNECTIONS WITH NRS RESILIENT SEATED SHUTOFF VALVES AND GROOVED CONNECTIONS

Model Number	Size	Qty. per Carton	Weight per Carton (Lbs.)	List Price (Each)
FDC2.50-NRS-G	2 1/2"	1	174	\$3,739
FDC3.00-NRS-G	3"	1	190	\$3,883
FDC4.00-NRS-G	4"	1	211	\$4,420
FDC6.00-NRS-G	6"	1	361	\$6,850
FDC8.00-NRS-G	8"	1	880	\$18,918
FDC10.00-NRS-G	10"	1	1140	\$22,783

FDC GROOVED

OSY RESILIENT SEATED SHUTOFF VALVES AND GROOVED CONNECTIONS

Model Number	Size	Qty. per Carton	Weight per Carton (Lbs.)	List Price (Each)
FDC2.50-OSY-G	2 1/2"	1	181	\$4,009
FDC3.00-OSY-G	3"	1	196	\$4,060
FDC4.00-OSY-G	4"	1	225	\$4,596
FDC6.00-OSY-G	6"	1	367	\$6,959
FDC8.00-OSY-G	8"	1	930	\$19,918
FDC10.00-OSY-G	10"	1	1240	\$23,784

OSY RESILIENT SEATED SHUTOFF VALVES, GROOVED CONNECTIONS COMPLIES AND IS LISTED TO UL

Model Number	Size	Qty. per Carton	Weight per Carton (Lbs.)	List Price (Each)
FDC2.50-OSY-G-UL	2 1/2"	1	181	\$4,129
FDC3.00-OSY-G-UL	3"	1	196	\$4,182
FDC4.00-OSY-G-UL	4"	1	225	\$4,734
FDC6.00-OSY-G-UL	6"	1	367	\$7,168
FDC8.00-OSY-G-UL	8"	1	930	\$20,515
FDC10.00-OSY-G-UL	10"	1	1240	\$24,497

DOUBLE CHECK BACKFLOW PREVENTER, LESS GATE VALVES, GROOVED CONNECTIONS

Model Number	Size	Qty. per Carton	Weight per Carton (Lbs.)	List Price (Each)
FDC2.50-LF	2 1/2"	1	72	\$3,673
FDC3.00-LF	3"	1	72	\$3,673
FDC4.00-LF	4"	1	72	\$3,673
FDC6.00-LF	6"	1	150	\$6,670
FDC8.00-LF	8"	1	360	\$8,946
FDC10.00-LF	10"	1	360	\$12,538



FDC3.00-OSY-DCDA (ILLUSTRATED)
FOR SPEC. SHEETS GO TO www.beecobackflow.com

BEECO BACKFLOW 2 1/2" THRU 4"

DCDA SERIES

(DCDA) WITH FLANGED CONNECTIONS DOUBLE CHECK DETECTOR ASSEMBLIES

OSY RESILIENT SEATED SHUTOFF VALVES, FLANGED CONNECTIONS COMPLIES AND IS LISTED TO UL

Model Number	Size	Qty. per Carton	Weight per Carton (Lbs.)	List Price (Each)
FDC2.50-OSY-DCDA-UL	2 1/2"	1	196	\$6,475
FDC3.00-OSY-DCDA-UL	3"	1	211	\$6,952
FDC4.00-OSY-DCDA-UL	4"	1	240	\$7,141
FDC6.00-OSY-DCDA-UL	6"	1	382	\$9,856
FDC8.00-OSY-DCDA-UL	8"	1	970	\$22,765
FDC10.00-OSY-DCDA-UL	10"	1	1290	\$27,050

BEECO Double Detector Check Assemblies prevent the backflow of contaminated materials back into the potable water supply. The DCDA valve incorporates a meter to detect and measure ground leaks and illegal taps, reducing water expenses.

Its modern, light-weight design is made of ductile iron and fused bonded epoxy coating. The shutoff devices are AWWA 509 compliant.



APPROVALS:

Tested and certified to A.S.S.E. Standard 1015, AWWA Compliant C510 (with gates only), CSA B64.5 and listed with IAPMO. Valves are tested and listed to UL

DOUBLE CHECK DETECTOR ASSEMBLIES (DCDA) WITH GROOVED CONNECTIONS

OSY RESILIENT SEATED SHUTOFF VALVES, GROOVED CONNECTIONS

Model Number	Size	Qty. per Carton	Weight per Carton (Lbs.)	List Price (Each)
FDC2.50-OSYG-DCDA-UL	2 1/2"	1	187	\$6,475
FDC3.00-OSYG-DCDA-UL	3"	1	200	\$6,952
FDC4.00-OSYG-DCDA-UL	4"	1	228	\$7,141
FDC6.00-OSYG-DCDA-UL	6"	1	363	\$9,856
FDC8.00-OSYG-DCDA-UL	8"	1	950	\$22,765
FDC10.0-OSYG-DCDA-UL	10"	1	1260	\$27,050

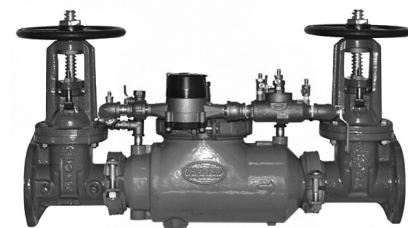

FDC3.00-OSY-DCDA (ILLUSTRATED)
FOR SPEC. SHEETS GO TO www.beecobackflow.com

Location: _____



Barracuda 20

DOUBLE CHECK BACKFLOW PREVENTER (DC)

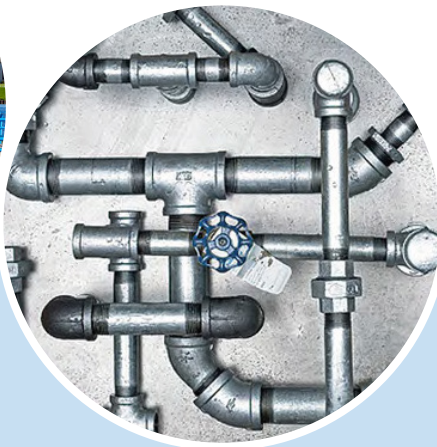
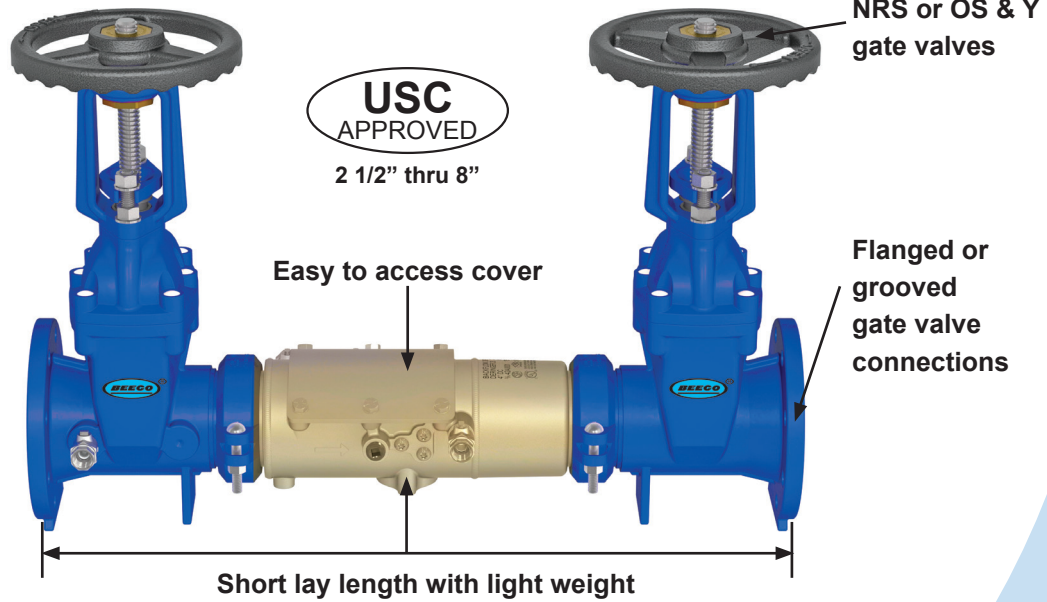

Introducing the Barracuda 20(x):

- The Shortest
- Lightest
- Most Economical
- Best Performing
- And ONLY All Stainless Steel Backflow Preventer

Specifically Designed For:

- Plumbing
- Irrigation
- Waterworks
- Indoor /Outdoor

CALIFORNIA PROPOSITION 65 WARNING. This product contains chemicals known to the State of California to cause cancer and birth defects or other reproductive harm.

Job Name: _____ Page No: _____
 Section No: _____ Contractor: _____
 Schedule No: _____ Purchase Order No: _____

BEECO® reserves the right to make changes in material and design without formal notice and obligation. USA: 1-800-465-2736 www.beecobackflow.com CAN: 1-800-387-3880

Location: _____



Barracuda 20

DOUBLE CHECK BACKFLOW PREVENTER (DC)



Flow Performance:

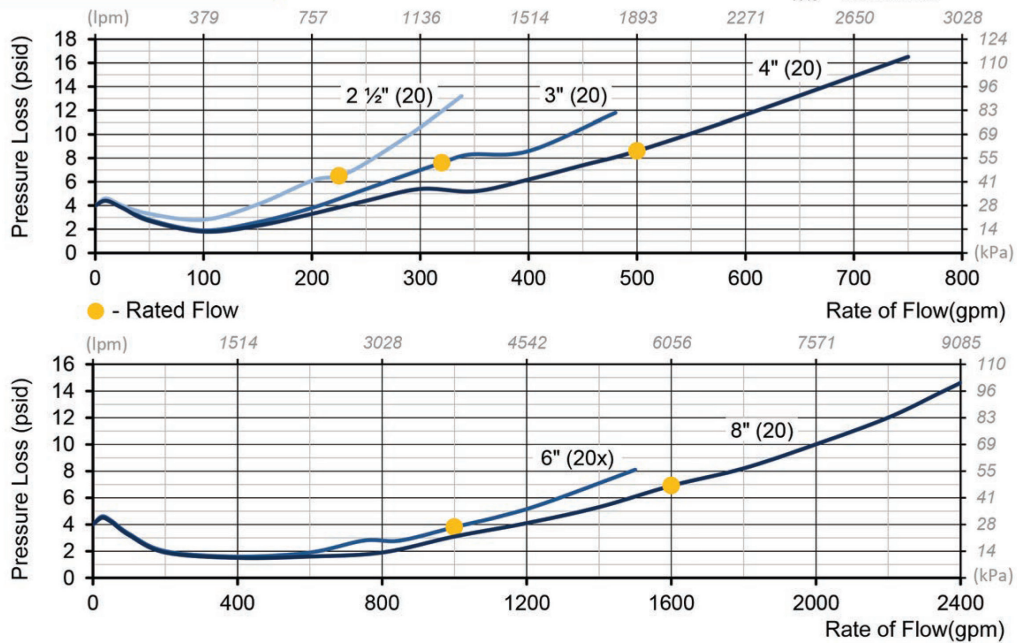

Measures and Materials:

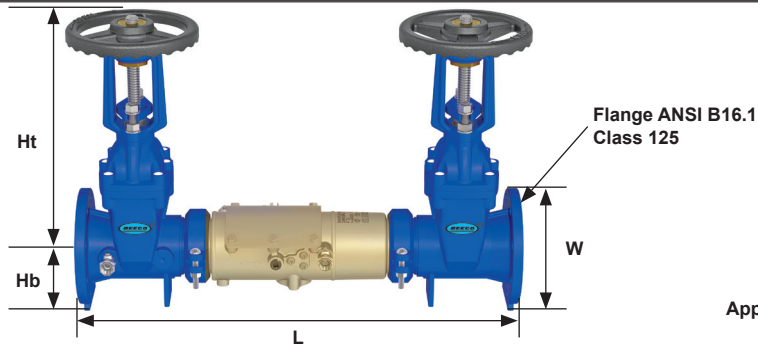

SIZE		MODEL	Ht.		Hb.		Ht. + Hb.		L		FLANGE		W		WEIGHT		DC ASSEMBLY WEIGHT (lbs.)		
IN	MM		IN	MM	IN	MM	IN	MM	IN	MM	IN	MM	IN	MM	Lbs.	Kg.	Model	OS&Y	NRS
2 1/2	65	20	19.00	483	3.6	92	22.6	574	31.9	810	2 1/2	65	11.0	279	122	55	GV2.5	121	101
3	80	20	19.5	495	3.8	97	23.3	592	31.9	810	3	80	11.0	279	126	57	GV3	145	117
4	100	20	22.5	572	4.5	114	27	686	33.9	861	4	100	11.0	279	160	73	GV4	166	150
6	150	20	30.9	785	5.5	140	36.4	925	42.8	1087	6	150	14.1	358	338	153	GV6	328	295
8	200	20	39.4	1001	6.8	173	46.2	1173	44.8	1138	8	200	14.6	371	452	205	GV8	411	401

- | | | |
|---|---|--|
| Valve Housing: 304 Stainless Steel | SOV Bearings: Teflon/Bronze | Check Springs: 17-7 Stainless Steel |
| Valve Cover: 304 Stainless Steel | on Wetted Bolts: Grade 8 Zinc Plated | Check Pins: 17-7/18-8 Stainless Steel |
| SOV Disks: EPDM/304SS | Wetted Fasteners: 18-8 Stainless Steel | Check Seats: Noryl Polymer |
| SOV Shafts: 304 Stainless Steel | Check Disks: Silicone | O-Rings: Buna-N |

CALIFORNIA PROPOSITION 65 WARNING. This product contains chemicals known to the State of California to cause cancer and birth defects or other reproductive harm.

Job Name: _____ Page No: _____
 Section No: _____ Contractor: _____
 Schedule No: _____ Purchase Order No: _____

BEECO® reserves the right to make changes in material and design without formal notice and obligation. USA: 1-800-465-2736 www.beecobackflow.com CAN: 1-800-387-3880

Design and dimensions are subject to modification. Prices do not include applicable taxes.

Visit www.beecobackflow.com for the most recent product information.

BEECO, Inc., 1321 West 119th Street, Chicago, Illinois 60643-5109, USA

Toll Free: 1-800-465-2736, Fax: 1-773-341-3049

All sales subject to BEECO's Terms and Warranties. Please refer to page no. 64.

sales@mifab.com • Canada Toll Free: 1-800-387-3880

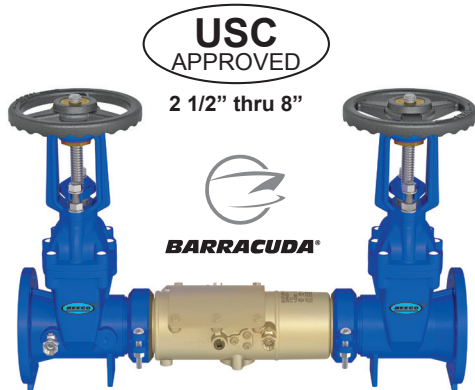

Specification: The BEECO® Series Barracuda 20 Double Check Valve Assembly (DC) is designed to prevent non-health hazard pollutants from entering the potable water supply system caused by backpressure and/or backsiphonage conditions

Sizes:
2 1/2" thru 8"

Working Pressure:
10-175 PSI

Lead Free Patents:
0.25% Maximum by Weight
backflowdirectpatents.com

"My favorite thing about MIFAB is the great people. They are wonderful starting with the owner, the Sales Managers and right n down the line."

- Dan Thomas of Ben Thomas and Associates,
Shade Gap, PA

- Valve Housing:** 304 Stainless Steel
- Valve Cover:** 304 Stainless Steel
- SOV Disks:** EPDM/304SS
- SOV Shafts:** 304 Stainless Steel
- SOV Bearings:** Teflon/Bronze
- on Wetted Bolts:** Grade 8 Zinc Plated
- Wetted Fasteners:** 18-8 Stainless Steel
- Check Disks:** Silicone
- Check Springs:** 17-7 Stainless Steel
- Check Pins:** 17-7/18-8 Stainless Steel
- Check Seats:** Noryl Polymer
- O-Rings:** Buna-N



BARRACUDA 20 FDC

DOUBLE CHECK BACKFLOW PREVENTOR

STAINLESS STEEL BODY AND NRS GATE VALVES FLANGED CONNECTIONS

Model Number	Size	Qty. per Carton	Weight per Carton (Lbs.)	List Price (Each)
FDC2.50-SS-NRS	2/1/2"	1	101	\$3,738
FDC3.00-SS-NRS	3"	1	117	\$3,881
FDC4.00-SS-NRS	4"	1	150	\$4,418
FDC6.00-SSX-NRS	6"	1	295	\$6,847
FDC8.00-SS-NRS	8"	1	401	\$18,908

DOUBLE CHECK BACKFLOW PREVENTOR

STAINLESS STEEL BODY AND NRS GATE VALVES WITH GROOVED ENDS

Model Number	Size	Qty. per Carton	Weight per Carton (Lbs.)	List Price (Each)
FDC2.50-SS-NRS-G	2/1/2"	1	96	\$3,738
FDC3.00-SS-NRS-G	3"	1	111	\$3,881
FDC4.00-SS-NRS-G	4"	1	140	\$4,418
FDC6.00-SSX-NRS-G	6"	1	280	\$6,847
FDC8.00-SS-NRS-G	8"	1	381	\$18,908

DOUBLE CHECK BACKFLOW PREVENTOR

STAINLESS STEEL BODY AND NRS GATE VALVES FLANGED CONNECTIONS STRAINER ATTACHED

Model Number	Size	Qty. per Carton	Weight per Carton (Lbs.)	List Price (Each)
FDC2.50-SS-NRS-S	2/1/2"	1	136	\$4,112
FDC3.00-SS-NRS-S	3"	1	155	\$4,385
FDC4.00-SS-NRS-S	4"	1	210	\$5,014
FDC6.00-SSX-NRS-S	6"	1	425	\$8,190
FDC8.00-SS-NRS-S	8"	1	676	\$20,924

DOUBLE CHECK BACKFLOW PREVENTOR

STAINLESS STEEL BODY AND OSY GATE VALVES FLANGED CONNECTIONS				
Model Number	Size	Qty. per Carton	Weight per Carton (Lbs.)	List Price (Each)
FDC2.50-SS-OSY	2 1/2"	1	121	\$4,009
FDC3.00-SS-OSY		1	145	\$4,060
FDC4.00-SS-OSY	4"	1	166	\$4,596
FDC6.00-SSX-OSY	6"	1	328	\$6,959
FDC8.00-SS-OSY	8"	1	411	\$19,918

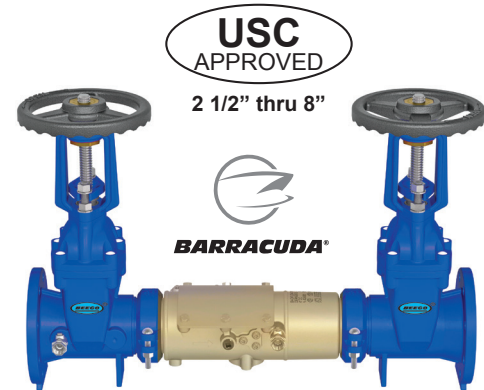

Specification: The BEECO® Series Barracuda 20 Double Check Valve Assembly (DC) is designed to prevent non-health hazard pollutants from entering the potable water supply system caused by backpressure and/or backsiphonage conditions

DOUBLE CHECK BACKFLOW PREVENTOR

STAINLESS STEEL BODY AND OSY GATE VALVES WITH GROOVED ENDS				
Model Number	Size	Qty. per Carton	Weight per Carton (Lbs.)	List Price (Each)
FDC2.50-SS-OSY-G	2 1/2"	1	116	\$4,009
FDC3.00-SS-OSY-G	3"	1	139	\$4,060
FDC4.00-SS-OSY-G	4"	1	156	\$4,596
FDC6.00-SSX-OSY-G	6"	1	313	\$6,959
FDC8.00-SS-OSY-G	8"	1	391	\$19,918

Sizes:
2 1/2" thru 8"

Working Pressure:
10-175 PSI

Lead Free Patents:
0.25% Maximum by Weight
backflowdirectpatents.com

- Valve Housing:** 304 Stainless Steel
- Valve Cover:** 304 Stainless Steel
- SOV Disks:** EPDM/304SS
- SOV Shafts:** 304 Stainless Steel
- SOV Bearings:** Teflon/Bronze
- on Wetted Bolts:** Grade 8 Zinc Plated
- Wetted Fasteners:** 18-8 Stainless Steel
- Check Disks:** Silicone
- Check Springs:** 17-7 Stainless Steel
- Check Pins:** 17-7/18-8 Stainless Steel
- Check Seats:** Noryl Polymer
- O-Rings:** Buna-N

DOUBLE CHECK BACKFLOW PREVENTOR

STAINLESS STEEL BODY AND OSY GATE VALVES FLANGED CONNECTIONS STRAINER ATTACHED				
Model Number	Size	Qty. per Carton	Weight per Carton (Lbs.)	List Price (Each)
FDC2.50-SS-OSY-S	2 1/2"	1	156	\$4,381
FDC3.00-SS-OSY-S	3"	1	183	\$4,561
FDC4.00-SS-OSY-S	4"	1	226	\$5,190
FDC6.00-SSX-OSY-S	6"	1	458	\$8,299
FDC8.00-SS-OSY-S	8"	1	686	\$21,924



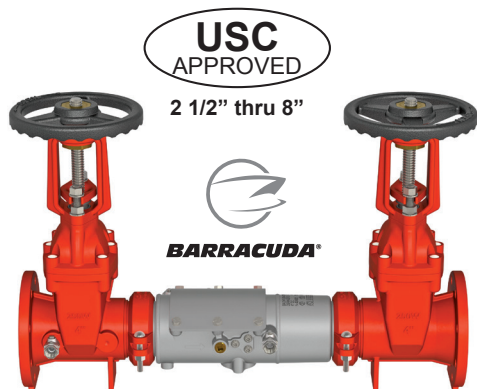

Specification: The BEECO® Series Barracuda 20 Double Check Valve Assembly (DC) is designed to prevent non-health hazard pollutants from entering the potable water supply system caused by backpressure and/or backsiphonage conditions

Sizes:

Working Pressure:

2½", 3", 4", 6"(x), 8"

Temperature Range:

10-175psi (0.7-12.1 bar)

Flanged Ends:

33°-140°F (1°-60°C) ANSI B16.1 Class 125

Lead Free: Patents:

0.25% Maximum by Weight
backflowdirectpatents.com

Valve Housing: 304 Stainless Steel

Valve Cover: 304 Stainless Steel

SOV Disks: EPDM/304SS

SOV Shafts: 304 Stainless Steel

SOV Bearings: Teflon/Bronze

on Wetted Bolts: Grade 8 Zinc Plated

Wetted Fasteners: 18-8 Stainless Steel

Check Disks: Silicone

Check Springs: 17-7 Stainless Steel

Check Pins: 17-7/18-8 Stainless Steel

Check Seats: Noryl Polymer

O-Rings: Buna-N



DOUBLE CHECK BACKFLOW PREVENTOR MEETS BUY AMERICA AND PSA STANDARDS

STAINLESS STEEL BODY AND NRS GATE VALVES FLANGED CONNECTIONS

Model Number	Size	Qty. per Carton	Weight per Carton (Lbs.)	List Price (Each)
FDC2.50-SS-NRS-BA	2/1/2"	1	101	\$4,438
FDC3.00-SS-NRS-BA	3"	1	117	\$4,581
FDC4.00-SS-NRS-BA	4"	1	150	\$5,118
FDC6.00-SSX-NRS-BA	6"	1	295	\$7,547
FDC8.00-SS-NRS-BA	8"	1	401	\$19,608

DOUBLE CHECK BACKFLOW PREVENTOR MEETS BUY AMERICA AND PSA STANDARDS

STAINLESS STEEL BODY AND NRS GATE VALVES WITH GROOVED ENDS

Model Number	Size	Qty. per Carton	Weight per Carton (Lbs.)	List Price (Each)
FDC2.50-SS-NRS-G-BA	2/1/2"	1	96	\$4,438
FDC3.00-SS-NRS-G-BA	3"	1	111	\$4,581
FDC4.00-SS-NRS-G-BA	4"	1	140	\$5,118
FDC6.00-SSX-NRS-G-BA	6"	1	280	\$7,547
FDC8.00-SS-NRS-G-BA	8"	1	381	\$19,608

DOUBLE CHECK BACKFLOW PREVENTOR MEETS BUY AMERICA AND PSA STANDARDS

STAINLESS STEEL BODY AND NRS GATE VALVES FLANGED CONNECTIONS STRAINER ATTACHED

Model Number	Size	Qty. per Carton	Weight per Carton (Lbs.)	List Price (Each)
FDC2.50-SS-NRS-S-BA	2/1/2"	1	136	\$4,812
FDC3.00-SS-NRS-S-BA	3"	1	155	\$5,085
FDC4.00-SS-NRS-S-BA	4"	1	210	\$5,714
FDC6.00-SSX-NRS-S-BA	6"	1	425	\$8,890
FDC8.00-SS-NRS-S-BA	8"	1	676	\$21,624

DOUBLE CHECK BACKFLOW PREVENTOR MEETS BUY AMERICA AND PSA STANDARDS

STAINLESS STEEL BODY AND OSY GATE VALVES FLANGED CONNECTIONS				
Model Number	Size	Qty. per Carton	Weight per Carton (Lbs.)	List Price (Each)
FDC2.50-SS-OSY-BA	2 1/2"	1	121	\$4,709
FDC3.00-SS-OSY-BA	3"	1	145	\$4,760
FDC4.00-SS-OSY-BA	4"	1	166	\$5,296
FDC6.00-SSX-OSY-BA	6"	1	328	\$7,659
FDC8.00-SS-OSY-BA	8"	1	411	\$20,618

DOUBLE CHECK BACKFLOW PREVENTOR MEETS BUY AMERICA AND PSA STANDARDS

STAINLESS STEEL BODY AND OSY GATE VALVES WITH GROOVED ENDS				
Model Number	Size	Qty. per Carton	Weight per Carton (Lbs.)	List Price (Each)
FDC2.50-SS-OSY-G-BA	2 1/2"	1	116	\$4,709
FDC3.00-SS-OSY-G-BA	3"	1	139	\$4,760
FDC4.00-SS-OSY-G-BA	4"	1	156	\$5,296
FDC6.00-SSX-OSY-G-BA	6"	1	313	\$7,659
FDC8.00-SS-OSY-G-BA	8"	1	391	\$20,618

DOUBLE CHECK BACKFLOW PREVENTOR MEETS BUY AMERICA AND PSA STANDARDS

STAINLESS STEEL BODY AND OSY GATE VALVES FLANGED CONNECTIONS STRAINER ATTACHED				
Model Number	Size	Qty. per Carton	Weight per Carton (Lbs.)	List Price (Each)
FDC2.50-SS-OSY-S-BA	2 1/2"	1	156	\$5,081
FDC3.00-SS-OSY-S-BA	3"	1	183	\$5,261
FDC4.00-SS-OSY-S-BA	4"	1	226	\$5,890
FDC6.00-SSX-OSY-S-BA	6"	1	458	\$8,999
FDC8.00-SS-OSY-S-BA	8"	1	686	\$22,624

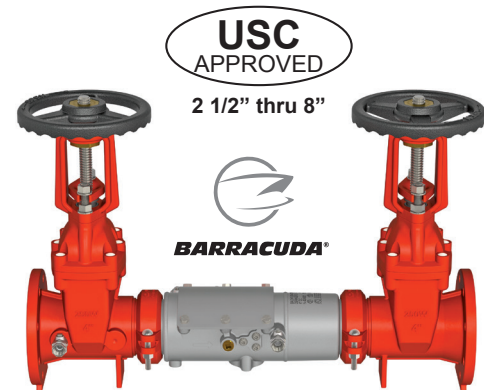

Specification: The BEECO® Series Barracuda 20 Double Check Valve Assembly (DC) is designed to prevent non-health hazard pollutants from entering the potable water supply system caused by backpressure and/or backsiphonage conditions

Sizes:

Working Pressure:

2 1/2", 3", 4", 6"(x), 8"

Temperature Range:

10-175psi (0.7-12.1 bar)

Flanged Ends:

33°-140°F (1°-60°C) ANSI B16.1

Class 125

Lead Free: Patents:

0.25% Maximum by Weight

backflowdirectpatents.com

"I feel comfortable calling MIFAB to ask for advice and assistance."

- Joe Ficek of Grumman Butkus, Consulting Engineers, Chicago, IL

Valve Housing: 304 Stainless Steel

Valve Cover: 304 Stainless Steel

SOV Disks: EPDM/304SS

SOV Shafts: 304 Stainless Steel

SOV Bearings: Teflon/Bronze

on Wetted Bolts: Grade 8 Zinc Plated

Wetted Fasteners: 18-8 Stainless Steel

Check Disks: Silicone

Check Springs: 17-7 Stainless Steel

Check Pins: 17-7/18-8 Stainless Steel

Check Seats: Noryl Polymer

O-Rings: Buna-N



BEECO REDUCED PRESSURE ZONE BACKFLOW PREVENTERS

“MIFAB has always been a very high quality product that has been backed by high quality Customer Service.”
 - Plumbing Wholesaler, Phoenix, Arizona

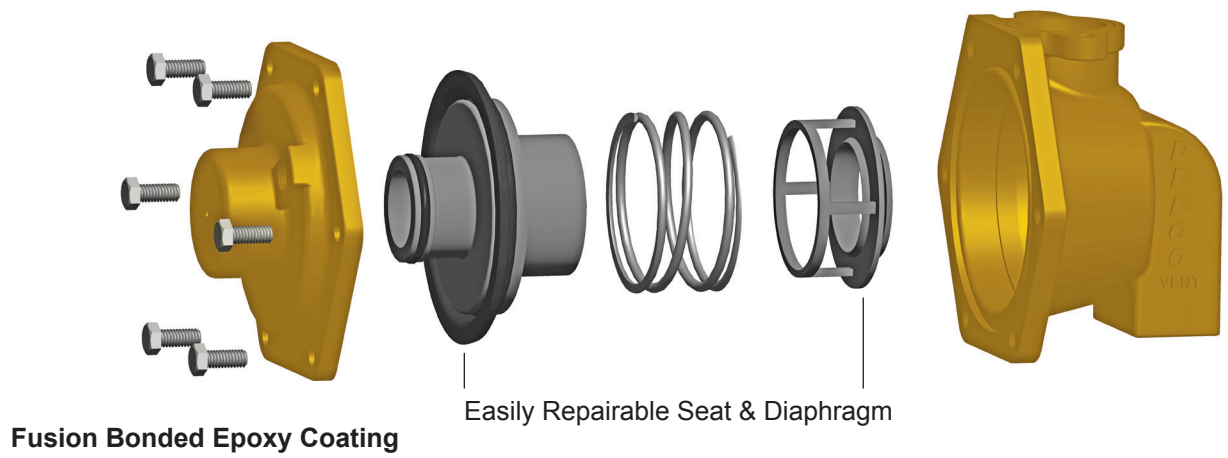
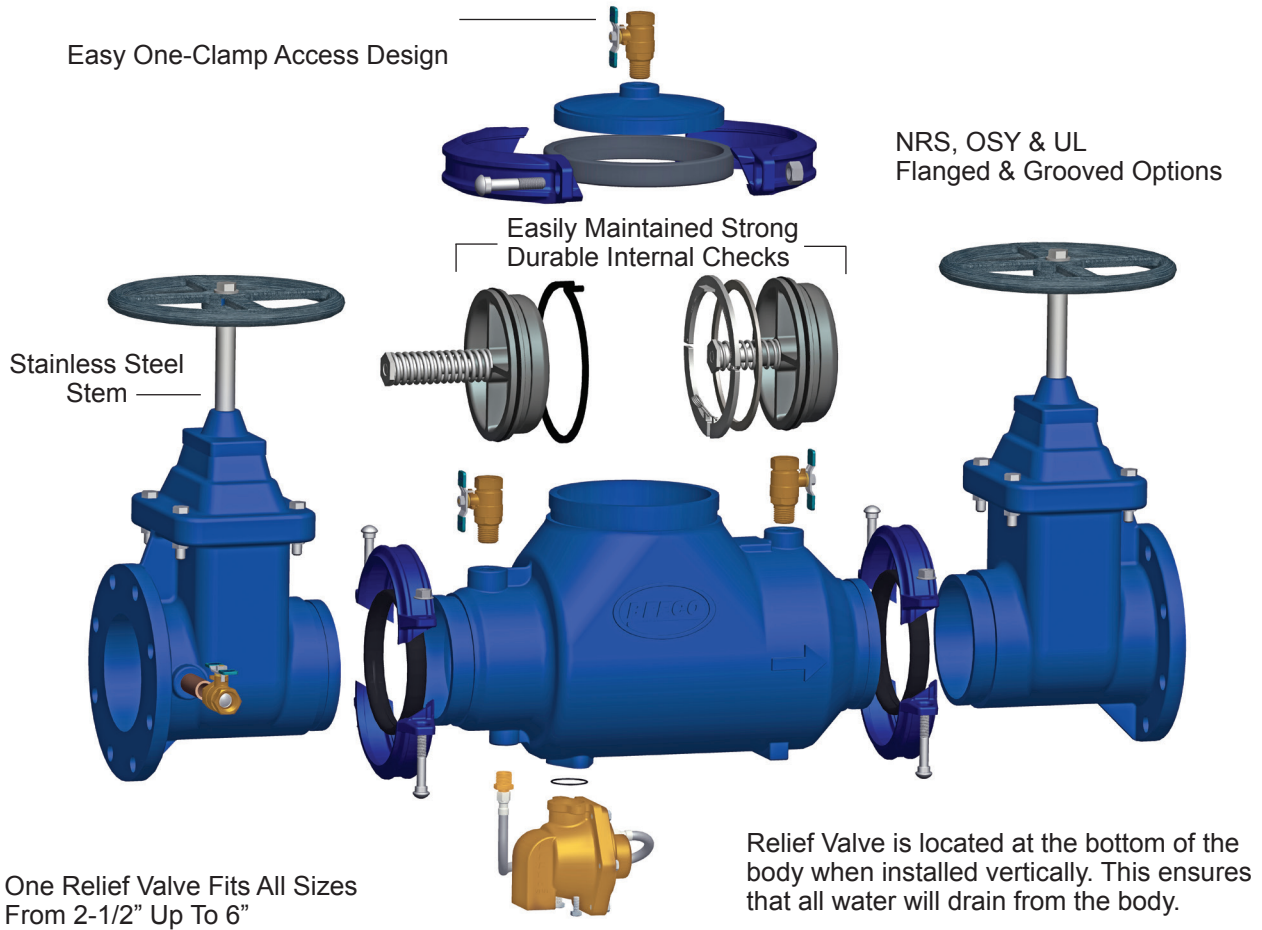

PURPOSE:

The BEECO FRP or Reduced Pressure Zone device is designed to eliminate contamination from cross connections in a potable water system. A cross connection is any physical connection between two separate systems, one of which contains drinking water and the other polluted or contaminated fluids chemicals or sewage. Contaminated water may flow through cross connections and between connected systems as the direction of flow can reverse depending on the pressure differential of each system. The BEECO Friendly Reduced Pressure Zone Device is designed for maximum protection in high-hazard applications

SIZING AND INSTALLATION GUIDE:

The BEECO Reduced Pressure Zone Device is made to fit all standard pipe sizes from a ½" supply line up to a 10" main supply line. These valves can be installed in either indoor or outdoor applications but need to be protected against freezing in cold weather climates. All backflow devices must be installed by a licensed plumbing professional and must be installed to your local and state plumbing codes. All Reduced Pressure Zone Devices must be retested each year by a trained licensed backflow specialist.

HOW IT WORKS:

A method to provide maximum protection to your drinking water is the BEECO Friendly Reduced Pressure Backflow Device. It protects your potable water supply without the need to re-establish pressure by means of pumps or towers, and it comes with both two internal checks and a relief valve that will dump all fluids. The checks are spring loaded with the first check being stronger than the second check, allowing the relief valve to dump contaminated fluid. Should a backpressure or back-siphonage occur in the system and start the flow of water in a reverse direction, and the second check fails for any reason, the relief valve will open while the first check continues to protect your water supply. To protect against indoor water damage refer to the BEECO ACV-HF-EOSSV Electric Override Safety Shutoff Valve.

FEATURES AND BENEFITS:

The new redesigned BEECO Reduced Pressure Zone Device was designed with input from hundreds of plumbers, and many backflow specialists were involved. It was designed with ease of access and a dramatic reduction in the number of spare parts needed. The light weight short lay length modular design makes this valve the easiest and quickest valve to perform your mandatory yearly certification on. For a complete list of all our features and benefits, see our website: www.beecobackflow.com. The BEECO Pressure Reduced Zone Device comes with a Detector Check By-pass and flow meter used on fire lines. See the RPDA product offering.



Distributed by: **MIFAB**

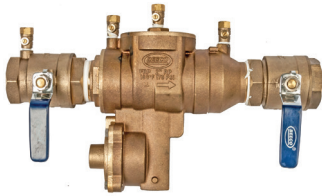

FRP.75-QT-LL (ILLUSTRATED)

FOR SPEC. SHEETS GO TO www.beecobackflow.com

SPECIFICATION: The BEECO Friendly Reduced Pressure Zone Backflow Preventer is designed to stop the reverse of flow of a liquid into a potable water system. The proper installation of a backflow preventer must be done by a certified expert under local codes and guidelines to assure the protection of the drinking water system. The Valve is certified to ASSE 1013, CSA B64.4 and listed with IAPMO.

FUNCTION: The assembly shall consist of two repairable positive seating check modules with captured springs and rubber seat discs. Service of all internal check components shall be through a single screwed in cover and designed for ease of access. The valve shall be equipped with a serviceable and replaceable relief valve with easy access repair and replacement while in line.

FEATURES: The checks are designed with a unique thumb screw holding in the disc to allow for easy removal of the check with a simple pair of pliers dramatically reducing part breakage during repair. The single threaded cover makes for the quickest access inside the valve in the industry. Repair parts are so modular it only takes two relief valve kits and three check repair kits to cover all sizes 1/2" through 2".

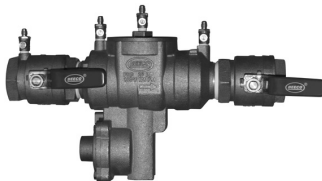

FRP2.00-QT-LL (ILLUSTRATED)

FOR SPEC. SHEETS GO TO www.beecobackflow.com



APPROVALS:

Tested and certified to A.S.S.E. Standard 1013, CSA B64.4 and listed with IAPMO.

FRP (SMALL)

REDUCED PRESSURE ZONE BACKFLOW PREVENTER LOW LEAD

WITH 1/4 TURN SHUTOFF VALVES

Model Number	Size	Qty. per Carton	Weight per Carton (Lbs.)	List Price (Each)
FRP.50-QT-LL	1/2"	1	6	\$380
FRP.75-QT-LL	3/4"	1	6	\$404
FRP1.00-QT-LL	1"	1	9	\$578
FRP1.25-QT-LL	1 1/4"	1	13	\$1,497
FRP1.50-QT-LL	1 1/2"	1	17	\$1,624
FRP2.00-QT-LL	2"	1	26	\$1,867

WITH 1/4 TURN SHUTOFF VALVES AND LOCKING HANDLES

Model Number	Size	Qty. per Carton	Weight per Carton (Lbs.)	List Price (Each)
FRP.50-QT-LH-LL	1/2"	1	6	\$418
FRP.75-QT-LH-LL	3/4"	1	6	\$444
FRP1.00-QT-LH-LL	1"	1	9	\$636
FRP1.25-QT-LH-LL	1 1/4"	1	13	\$1,647
FRP1.50-QT-LH-LL	1 1/2"	1	17	\$1,786
FRP2.00-QT-LH-LL	2"	1	26	\$2,054

WITH 1/4 TURN SHUTOFF VALVES AND STAINLESS STEEL HANDLES

Model Number	Size	Qty. per Carton	Weight per Carton (Lbs.)	List Price (Each)
FRP.50-QT-SH-LL	1/2"	1	6	\$418
FRP.75-QT-SH-LL	3/4"	1	6	\$444
FRP1.00-QT-SH-LL	1"	1	9	\$636
FRP1.25-QT-SH-LL	1 1/4"	1	13	\$1,647
FRP1.50-QT-SH-LL	1 1/2"	1	17	\$1,786
FRP2.00-QT-SH-LL	2"	1	26	\$2,054

WITH 1/4 TURN SHUTOFF VALVES AND WYE TYPE STRAINER

Model Number	Size	Qty. per Carton	Weight per Carton (Lbs.)	List Price (Each)
FRP.50-QT-S-LL	1/2"	1	7	\$406
FRP.75-QT-S-LL	3/4"	1	7	\$446
FRP1.00-QT-S-LL	1"	1	10	\$644
FRP1.25-QT-S-LL	1 1/4"	1	15	\$1,595
FRP1.50-QT-S-LL	1 1/2"	1	19	\$1,763
FRP2.00-QT-S-LL	2"	1	31	\$2,092

LESS SHUTOFFS				
Model Number	Size	Qty. per Carton	Weight per Carton (Lbs.)	List Price (Each)
FRP.50-LF-LL	1/2"	1	5	\$290
FRP.75-LF-LL	3/4"	1	5	\$308
FRP1.00-LF-LL	1"	1	7	\$442
FRP1.25-LF-LL	1 1/4"	1	10	\$1,144
FRP1.50-LF-LL	1 1/2"	1	13	\$1,240
FRP2.00-LF-LL	2"	1	20	\$1,426

"Mifab's line of Beeco backflow devices equals quality at an affordable price"

- Jeff Cisar, Prochazka Plumbing

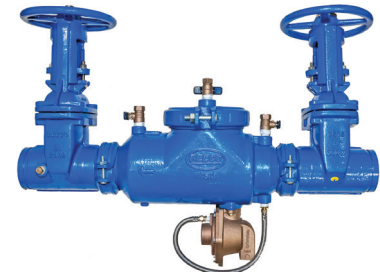

FRP4.00-NRS (ILLUSTRATED)

FOR SPEC. SHEETS GO TO www.beecobackflow.com

FRP (LARGE)

REDUCED PRESSURE ZONE BACKFLOW PREVENTER

WITH FLANGED CONNECTIONS, DUCTILE IRON SHUTOFF DEVICES NRS RESILIENT SEATED SHUTOFF VALVES

Model Number	Size	Qty. per Carton	Weight per Carton (Lbs.)	List Price (Each)
FRP2.50-NRS	2 1/2"	1	193	\$4,378
FRP3.00-NRS	3"	1	210	\$4,529
FRP4.00-NRS	4"	1	232	\$5,090
FRP6.00-NRS	6"	1	390	\$7,535
FRP8.00-NRS	8"	1	940	\$20,758
FRP10.00-NRS	10"	1	1210	\$24,622



FRP3.00-NRS (ILLUSTRATED)

FOR SPEC. SHEETS GO TO www.beecobackflow.com

OSY RESILIENT SEATED SHUTOFF VALVES

Model Number	Size	Qty. per Carton	Weight per Carton (Lbs.)	List Price (Each)
FRP2.50-OSY	2 1/2"	1	201	\$4,444
FRP3.00-OSY	3"	1	216	\$4,670
FRP4.00-OSY	4"	1	247	\$5,267
FRP6.00-OSY	6"	1	396	\$7,628
FRP8.00-OSY	8"	1	990	\$21,757
FRP10.00-OSY	10"	1	1310	\$25,621

All BEECO FRP valves 2 1/2" thru 4" can be installed in the vertical position.

BEECO Reduced Pressure Backflow Prevention Devices are designed to protect against contamination of potable water. Installation and selection of the proper device should be made by a qualified licensed professional.



APPROVALS:

Tested and certified to A.S.S.E. Standard 1013, CSA B64.4 and listed with IAPMO.

APPROVALS:

Tested and certified to A.S.S.E. Standard 1013, CSA B64.4 and listed with IAPMO. Valves are tested and listed to UL

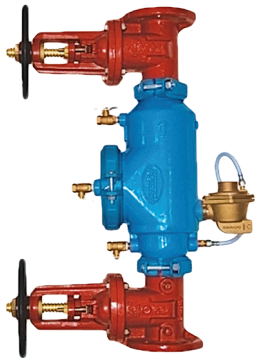
FRP4.00-OSY-UL (ILLUSTRATED)

FOR SPEC. SHEETS GO TO www.beecobackflow.com

All BEECO FRP valves 2 1/2" thru 4" can be installed in the vertical position.

RATINGS:

Maximum working water pressure 175 PSI, Maximum working temperature 140° F, Hydrostatic test pressure 350 PSI, Flanged end connection meet ANSI B16.1 and all grooved dimensions comply with AWWA C606.

Complies with AWWA-C511. All RP devices must be install where a drain is available to cover the discharge in the event there is a backflow condition and the relief valve discharges.

DISCHARGE RATES ARE AS FOLLOWS:

1/2" to 1" 5 GPM,
1 1/4" to 2" 20 GPM,
2 1/2" to 6" 20 GPM, and
8" to 10" 60 GPM.

OSY RESILIENT SEATED SHUTOFF VALVES, FLANGED CONNECTIONS COMPLIES WITH AND IS LISTED TO UL

Model Number	Size	Qty. per Carton	Weight per Carton (Lbs.)	List Price (Each)
FRP2.50-OSY-UL	2 1/2"	1	201	\$4,578
FRP3.00-OSY-UL	3"	1	216	\$4,811
FRP4.00-OSY-UL	4"	1	247	\$5,424
FRP6.00-OSY-UL	6"	1	396	\$7,858
FRP8.00-OSY-UL	8"	1	990	\$22,410
FRP10.00-OSY-UL	10"	1	1310	\$26,389

OSY RESILIENT SEATED SHUTOFF VALVES, WITH A FLANGED STRAINER

Model Number	Size	Qty. per Carton	Weight per Carton (Lbs.)	List Price (Each)
FRP2.50-OSY-S	2 1/2"	1	237	\$4,784
FRP3.00-OSY-S	3"	1	259	\$5,137
FRP4.00-OSY-S	4"	1	315	\$5,822
FRP6.00-OSY-S	6"	1	556	\$8,934
FRP8.00-OSY-S	8"	1	1265	\$23,636
FRP10.00-OSY-S	10"	1	1820	\$28,844

NRS RESILIENT SEATED SHUTOFF VALVES, WITH A FLANGED STRAINER

Model Number	Size	Qty. per Carton	Weight per Carton (Lbs.)	List Price (Each)
FRP2.50-NRS-S	2 1/2"	1	237	\$4,957
FRP3.00-NRS-S	3"	1	259	\$5,250
FRP4.00-NRS-S	4"	1	315	\$5,938
FRP6.00-NRS-S	6"	1	556	\$9,289
FRP8.00-NRS-S	8"	1	1215	\$23,819
FRP10.00-NRS-S	10"	1	1620	\$29,287

FRP SERIES

REDUCED PRESSURE ZONE BACKFLOW PREVENTER

WITH GROOVED CONNECTIONS, DUCTILE IRON SHUTOFF DEVICES NRS RESILIENT SEATED SHUTOFF VALVES

Model Number	Size	Qty. per Carton	Weight per Carton (Lbs.)	List Price (Each)
FRP2.50-NRS-G	2 1/2"	1	183	\$4,378
FRP3.00-NRS-G	3"	1	200	\$4,529
FRP4.00-NRS-G	4"	1	220	\$5,090
FRP6.00-NRS-G	6"	1	371	\$7,535
FRP8.00-NRS-G	8"	1	920	\$20,758
FRP10.00-NRS-G	10"	1	1180	\$24,622

"Performing maintenance on Beeco backflows is simplistic and fast"

- Joe Hallman, All City Bckflow

BEECO Reduced Pressure Backflow Prevention Devices are designed to protect against contamination of potable water. Installation and selection of the proper device should be made by a qualified licensed professional.



FRP4.00-OSY-G (ILLUSTRATED)
FOR SPEC. SHEETS GO TO
www.beecobackflow.com

OSY RESILIENT SEATED SHUTOFF VALVES WITH GROOVED CONNECTIONS

Model Number	Size	Qty. per Carton	Weight per Carton (Lbs.)	List Price (Each)
FRP2.50-OSY-G	2 1/2"	1	191	\$4,444
FRP3.00-OSY-G	3"	1	205	\$4,670
FRP4.00-OSY-G	4"	1	235	\$5,267
FRP6.00-OSY-G	6"	1	376	\$7,628
FRP8.00-OSY-G	8"	1	970	\$21,757
FRP10.00-OSY-G	10"	1	1280	\$25,621



APPROVALS:

Tested and certified to A.S.S.E. Standard 1013, AWWA Compliant C510 (with gates only), CSA B64.4 and listed with IAPMO.



FRP4.00-OSY-G-BA (ILLUSTRATED)
FOR SPEC. SHEETS GO TO
www.beecobackflow.com

LESS SHUT OFF DEVICES, GROOVED CONNECTIONS				
Model Number	Size	Qty. per Carton	Weight per Carton (Lbs.)	List Price (Each)
FRP2.50-LF	2 1/2"	1	82	\$4,513
FRP3.00-LF	3"	1	82	\$4,513
FRP4.00-LF	4"	1	82	\$4,513
FRP6.00-LF	6"	1	150	\$7,510
FRP8.00-LF	8"	1	300	\$10,627
FRP10.00-LF	10"	1	300	\$14,218

All FDC and FRP devices 2 1/2" thru 10" are available to meet the BUY AMERICA ACT and the PENNSYLVANIA STEEL ACT call customer service for pricing and lead times.



FRP4.00-LF (ILLUSTRATED)
FOR SPEC. SHEETS GO TO
www.beecobackflow.com

BEECO Reduced Pressure Backflow Prevention Devices are designed to protect against contamination of potable water. Installation and selection of the proper device should be made by a qualified licensed professional.

SUFFIX	OPTIONAL VARIATIONS
-BA	Meets Buy America and Pennsylvania Steel Act
-DCDA	Double Check Detector Assembly
-G	Grooved Flange Connection
-LF	No Gate Valves
-NRS	Non Rising Stem Gate Valve
-OSY	Outside Stem and Yoke Gate Valve
-S	Strainer Attached
-UL	UL tested and approved



APPROVALS:

Tested and certified to A.S.S.E. Standard 1013, AWWA Compliant C510 (with gates only), CSA B64.4 and listed with IAPMO.

RPDA SERIES

REDUCED PRESSURE DETECTOR ASSEMBLIES (RPDA)

OSY RESILIENT SEATED SHUTOFF VALVES, COMPLIES AND IS LISTED WITH UL FLANGED CONNECTIONS

Model Number	Size	Qty. per Carton	Weight per Carton (Lbs.)	List Price (Each)
FRP2.50-OSY-RPDA-UL	2 1/2"	1	211	\$5,956
FRP3.00-OSY-RPDA-UL	3"	1	225	\$6,182
FRP4.00-OSY-RPDA-UL	4"	1	255	\$6,779
FRP6.00-OSY-RPDA-UL	6"	1	396	\$9,140
FRP8.00-OSY-RPDA-UL	8"	1	990	\$24,277
FRP10.00-OSY-RPDA-UL	10"	1	1300	\$28,141

"we have installed many of the 4" RPZ in our hotel and we value the quality of the product and the ease of installation"

- Sal, Pipeline Services

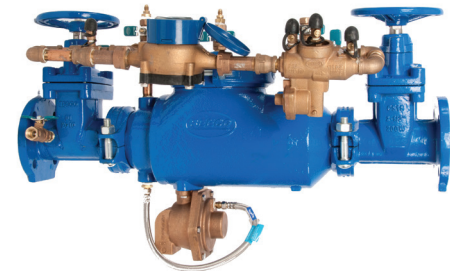

FRP3.00-OSY-RPDA (ILLUSTRATED)
FOR SPEC. SHEETS GO TO www.beecobackflow.com



APPROVALS:

Tested and certified to A.S.S.E. Standard 1013, AWWA Compliant C510 (with gates only), CSA B64.4 and listed with IAPMO. Valves are tested and listed to UL

REDUCED PRESSURE DETECTOR ASSEMBLIES (RPDA)

OSY RESILIENT SEATED SHUTOFF VALVES, GROOVED CONNECTIONS COMPLIES AND IS LISTED WITH UL

Model Number	Size	Qty. per Carton	Weight per Carton (Lbs.)	List Price (Each)
FRP2.50-OSYG-RPDA-UL	2 1/2"	1	200	\$5,956
FRP3.00-OSYG-RPDA-UL	3"	1	214	\$6,182
FRP4.00-OSYG-RPDA-UL	4"	1	242	\$6,779
FRP6.00-OSYG-RPDA-UL	6"	1	376	\$9,140
FRP8.00-OSYG-RPDA-UL	8"	1	941	\$24,277
FRP10.0-OSYG-RPDA-UL	10"	1	1235	\$28,141



FRP4.00-RPDA-BA (ILLUSTRATED)
FOR SPEC. SHEETS GO TO www.beecobackflow.com

Location: _____



Barracuda 40

REDUCED PRESSURE VALVE PREVENTER (RPZ)

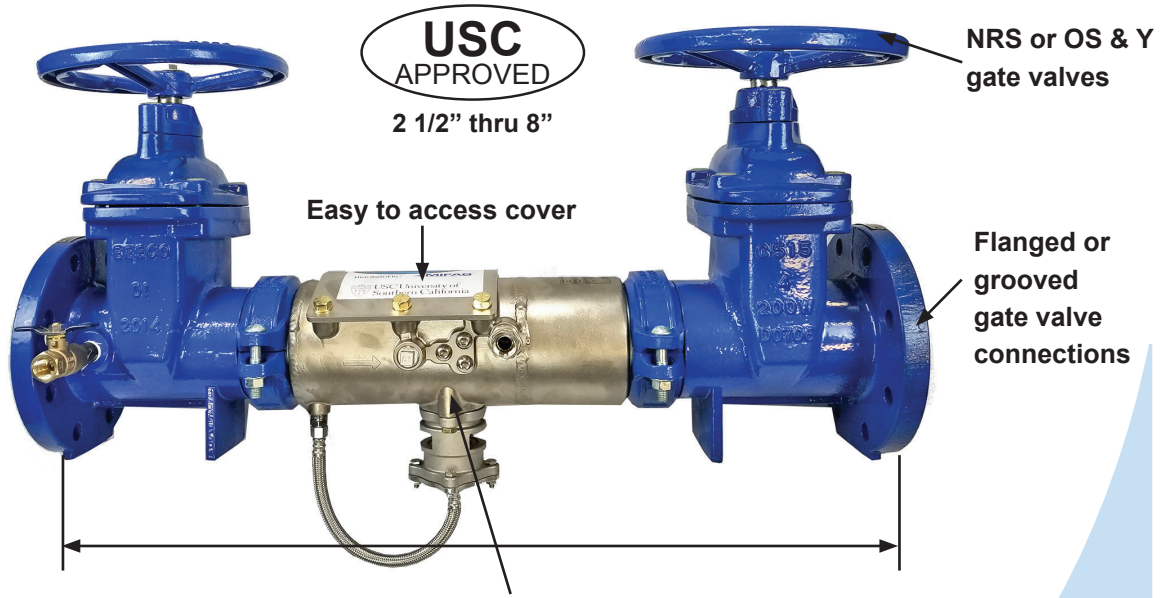

Short lay length with light weight

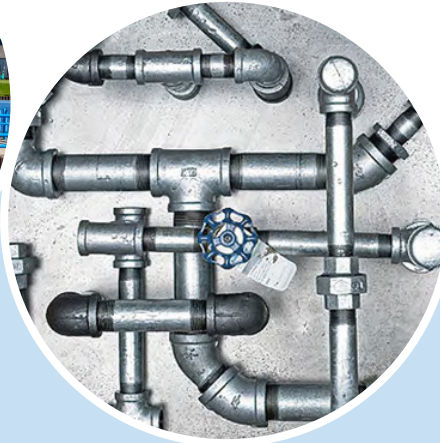

Introducing the Barracuda 40(x):

- The Shortest
- Lightest
- Most Economical
- Best Performing
- And ONLY All Stainless Steel Backflow Preventer

Specifically Designed For:

- Plumbing
- Irrigation
- Waterworks

CALIFORNIA PROPOSITION 65 WARNING. This product contains chemicals known to the State of California to cause cancer and birth defects or other reproductive harm.

Job Name: _____ Page No: _____
 Section No: _____ Contractor: _____
 Schedule No: _____ Purchase Order No: _____

BEECO® reserves the right to make changes in material and design without formal notice and obligation. USA: 1-800-465-2736 www.beecobackflow.com CAN: 1-800-387-3880

Location: _____



Barracuda 40

REDUCED PRESSURE VALVE PREVENTER (RPZ)



Flow Performance:

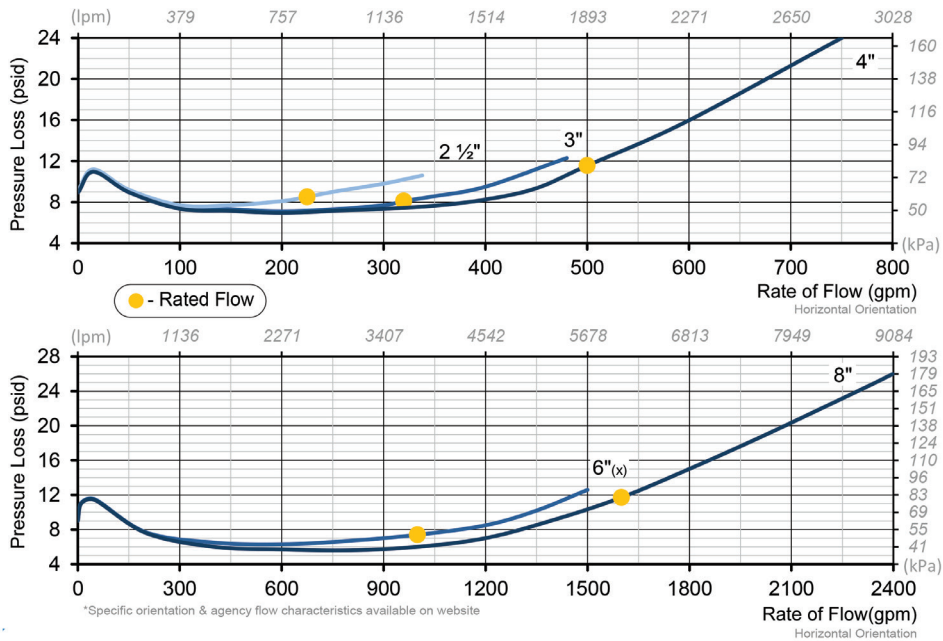

Measures and Materials:

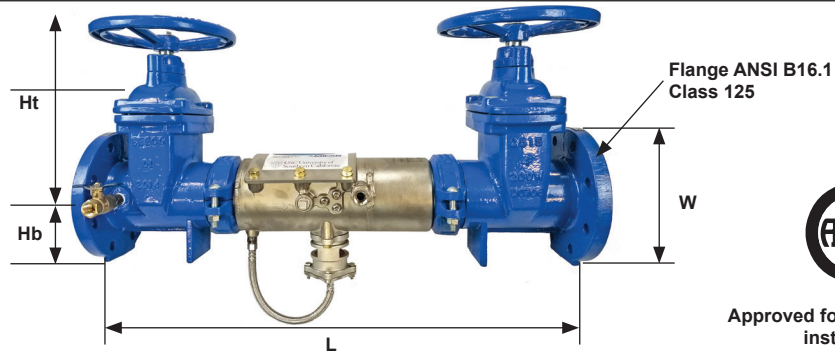

Approved for indoor/outdoor installation:

SIZE		MODEL	Ht.		Hb.		Ht. + Hb.		L		FLANGE		W		WEIGHT		RP ASSEMBLY WEIGHT (lbs.)		
IN	MM		IN	MM	IN	MM	IN	MM	IN	MM	IN	MM	IN	MM	Lbs.	Kg.	Model	OS&Y	NRS
2 1/2	65	40	12.5	318	9.9	251	22.4	569	31.9	810	2 1/2	65	11.0	279	106	48	GV2.5	124	104
3	80	40	13.5	343	10.1	257	23.6	599	31.9	810	3	80	11.0	279	110	50	GV3	148	120
4	100	40	14.0	356	10.8	274	24.8	630	33.9	861	4	100	11.0	279	152	69	GV4	169	153
6	150	40	18.1	460	11.8	300	29.9	759	44.8	1138	6	150	14.1	358	294	133	GV6	331	298
8	200	40	22.0	559	13.1	333	35.1	892	44.8	1138	8	200	14.6	371	420	191	GV8	414	404

- | | | |
|---|---|--|
| Valve Housing: 304 Stainless Steel | SOV Bearings: Teflon/Bronze | Check Springs: 17-7 Stainless Steel |
| Valve Cover: 304 Stainless Steel | Non Wetted Bolts: Grade 8 Zinc Plated | Check Pins: 17-7/18-8 Stainless Steel |
| SOV Disks: EPDM/304SS | Wetted Fasteners: 18-8 Stainless Steel | Check Seats: Noryl Polymer |
| SOV Shafts: 304 Stainless Steel | All Check Disks: Silicone | O-Rings: Buna-N |
| RV Spring: 302 Stainless Steel | RV Housing: 302 Stainless Steel | RV Hose: Braided Stainless Steel Wire |

CALIFORNIA PROPOSITION 65 WARNING. This product contains chemicals known to the State of California to cause cancer and birth defects or other reproductive harm.

Job Name: _____ Page No: _____
 Section No: _____ Contractor: _____
 Schedule No: _____ Purchase Order No: _____

BEECO® reserves the right to make changes in material and design without formal notice and obligation. USA: 1-800-465-2736 www.beecobackflow.com CAN: 1-800-387-3880

Design and dimensions are subject to modification. Prices do not include applicable taxes.

Visit www.beecobackflow.com for the most recent product information.

BEECO, Inc., 1321 West 119th Street, Chicago, Illinois 60643-5109, USA

Toll Free: 1-800-465-2736, Fax: 1-773-341-3049

All sales subject to BEECO's Terms and Warranties. Please refer to page no. 64.

sales@mifab.com • Canada Toll Free: 1-800-387-3880



2 1/2" thru 8"

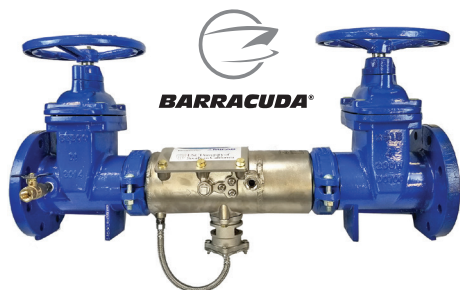

Function: The BEECO® Series Barracuda 40 REDUCED PRESSURE VALVE Backflow Prevention Valve prevents non-health hazard pollutants and hazardous contaminants from entering a potable water supply system when backpressure and/or backsiphonage conditions occur. This product is designed for the waterwork, plumbing, and irrigation markets only.

Sizes: 2 1/2", 3", 4", 6"(x), 8"

Working Pressure:
10-175psi (0.7-12.1 bar)

Temperature Range:
33°-140°F (1°-60°C)

Flanged Ends:
ANSI B16.1 Class 125

Lead Free: Patents:
0.25% Maximum by Weight

"We have installed many of the 4" Beeco RPZ in our hotel projects and we value the quality of the product and the easy installation."

- Sal from Pipeline Services

BARRACUDA 40 FRP

REDUCED PRESSURE ZONE BACKFLOW PREVENTOR

STAINLESS STEEL BODY AND NRS GATE VALVES FLANGED CONNECTIONS				
Model Number	Size	Qty. per Carton	Weight per Carton (Lbs.)	List Price (Each)
FRP2.50-SS-NRS	2/1/2"	1	104	\$4,378
FRP3.00-SS-NRS	3"	1	120	\$4,529
FRP4.00-SS-NRS	4"	1	153	\$5,090
FRP6.00-SSX-NRS	6"	1	298	\$7,535
FRP8.00-SS-NRS	8"	1	404	\$20,758

REDUCED PRESSURE ZONE BACKFLOW PREVENTOR

STAINLESS STEEL BODY AND NRS GATE VALVES GROOVED CONNECTIONS				
Model Number	Size	Qty. per Carton	Weight per Carton (Lbs.)	List Price (Each)
FRP2.50-SS-NRS-G	2/1/2"	1	99	\$4,378
FRP3.00-SS-NRS-G	3"	1	114	\$4,529
FRP4.00-SS-NRS-G	4"	1	143	\$5,090
FRP6.00-SSX-NRS-G	6"	1	283	\$7,535
FRP8.00-SS-NRS-G	8"	1	384	\$20,758

REDUCED PRESSURE ZONE BACKFLOW PREVENTOR

STAINLESS STEEL BODY AND NRS GATE VALVES FLANGED CONNECTIONS STRAINER ATTACHED				
Model Number	Size	Qty. per Carton	Weight per Carton (Lbs.)	List Price (Each)
FRP2.50-SS-NRS-S	2/1/2"	1	139	\$4,784
FRP3.00-SS-NRS-S	3"	1	158	\$5,137
FRP4.00-SS-NRS-S	4"	1	213	\$5,822
FRP6.00-SSX-NRS-S	6"	1	428	\$8,934
FRP8.00-SS-NRS-S	8"	1	679	\$23,636

REDUCED PRESSURE ZONE BACKFLOW PREVENTOR

STAINLESS STEEL BODY AND OSY GATE VALVES FLANGED CONNECTIONS				
Model Number	Size	Qty. per Carton	Weight per Carton (Lbs.)	List Price (Each)
FRP2.50-SS-OSY	2/1/2"	1	124	\$4,444
FRP3.00-SS-OSY	3"	1	148	\$4,670
FRP4.00-SS-OSY	4"	1	169	\$5,267
FRP6.00-SSX-OSY	6"	1	331	\$7,628
FRP8.00-SS-OSY	8"	1	414	\$21,757

USC
APPROVED
2 1/2" thru 8"

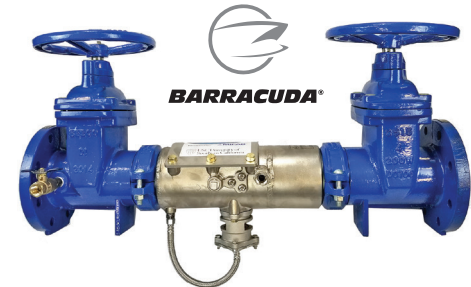

Function: The BEECO® Series Barracuda 40 REDUCED PRESSURE VALVE Backflow Prevention Valve prevents non-health hazard pollutants and hazardous contaminants from entering a potable water supply system when backpressure and/ or backsiphonage conditions occur. This product is designed for the waterwork, plumbing, and irrigation markets only.

REDUCED PRESSURE ZONE BACKFLOW PREVENTOR

STAINLESS STEEL BODY AND OSY GATE VALVES GROOVED CONNECTIONS				
Model Number	Size	Qty. per Carton	Weight per Carton (Lbs.)	List Price (Each)
FRP2.50-SS-OSY-G	2/1/2"	1	119	\$4,444
FRP3.00-SS-OSY-G	3"	1	142	\$4,670
FRP4.00-SS-OSY-G	4"	1	159	\$5,267
FRP6.00-SSX-OSY-G	6"	1	316	\$7,628
FRP8.00-SS-OSY-G	8"	1	394	\$21,757

Sizes: 2½", 3", 4", 6"(x), 8"

Working Pressure: 10-175psi (0.7-12.1 bar)

Temperature Range: 33°-140°F (1°-60°C)

Flanged Ends: ANSI B16.1 Class 125

Lead Free: Patents: 0.25% Maximum by Weight

Valve Housing: 304 Stainless Steel

Valve Cover: 304 Stainless Steel

SOV Disks: EPDM/304SS

SOV Shafts: 304 Stainless Steel

RV Spring: 302 Stainless Steel

SOV Bearings: Teflon/Bronze

Non Wetted Bolts: Grade 8 Zinc Plated

Wetted Fasteners: 18-8 Stainless Steel

All Check Disks: Silicone

RV Housing: 302 Stainless

Steel Check Springs: 17-7 Stainless Steel

Check Pins: 17-7/18-8
Stainless Steel

Check Seats: Noryl Polymer

O-Rings: Buna-N

RV Hose: Braided Stainless Steel Wire

REDUCED PRESSURE ZONE BACKFLOW PREVENTOR

STAINLESS STEEL BODY AND OSY GATE VALVES FLANGED CONNECTIONS STRAINER ATTACHED				
Model Number	Size	Qty. per Carton	Weight per Carton (Lbs.)	List Price (Each)
FRP2.50-SS-OSY-S	2/1/2"	1	159	\$4,957
FRP3.00-SS-OSY-S	3"	1	186	\$5,250
FRP4.00-SS-OSY-S	4"	1	229	\$5,938
FRP6.00-SSX-OSY-S	6"	1	461	\$9,289
FRP8.00-SS-OSY-S	8"	1	689	\$23,819





2 1/2" thru 8"

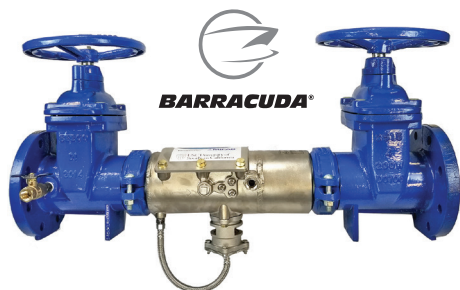

Function: The BEECO® Series Barracuda 40 REDUCED PRESSURE VALVE Backflow Prevention Valve prevents non-health hazard pollutants and hazardous contaminants from entering a potable water supply system when backpressure and/or backsiphonage conditions occur. This product is designed for the waterwork, plumbing, and irrigation markets only.

Sizes: 2½", 3", 4", 6"(x), 8"

Working Pressure:
10-175psi (0.7-12.1 bar)

Temperature Range:
33°-140°F (1°-60°C)

Flanged Ends:
ANSI B16.1 Class 125

Lead Free: Patents:
0.25% Maximum by Weight

Valve Housing: 304 Stainless Steel

Valve Cover: 304 Stainless Steel

SOV Disks: EPDM/304SS

SOV Shafts: 304 Stainless Steel

RV Spring: 302 Stainless Steel

SOV Bearings: Teflon/Bronze

Non Wetted Bolts: Grade 8 Zinc Plated

Wetted Fasteners: 18-8 Stainless Steel

All Check Disks: Silicone

RV Housing: 302 Stainless

Steel Check Springs: 17-7 Stainless Steel

Check Pins: 17-7/18-8
Stainless Steel

Check Seats: Noryl Polymer

O-Rings: Buna-N

RV Hose: Braided Stainless Steel Wire

REDUCED PRESSURE ZONE BACKFLOW PREVENTOR MEETS BUY AMERICA AND PSA STANDARDS

STAINLESS STEEL BODY AND NRS GATE VALVES FLANGED CONNECTIONS				
Model Number	Size	Qty. per Carton	Weight per Carton (Lbs.)	List Price (Each)
FRP2.50-SS-NRS-BA	2/1/2"	1	104	\$5,078
FRP3.00-SS-NRS-BA	3"	1	120	\$5,229
FRP4.00-SS-NRS-BA	4"	1	153	\$5,790
FRP6.00-SSX-NRS-BA	6"	1	298	\$8,235
FRP8.00-SS-NRS-BA	8"	1	404	\$21,458

REDUCED PRESSURE ZONE BACKFLOW PREVENTOR MEETS BUY AMERICA AND PSA STANDARDS

STAINLESS STEEL BODY AND NRS GATE VALVES GROOVED CONNECTIONS				
Model Number	Size	Qty. per Carton	Weight per Carton (Lbs.)	List Price (Each)
FRP2.50-SS-NRS-G-BA	2/1/2"	1	99	\$5,078
FRP3.00-SS-NRS-G-BA	3"	1	114	\$5,229
FRP4.00-SS-NRS-G-BA	4"	1	143	\$5,790
FRP6.00-SSX-NRS-G-BA	6"	1	283	\$8,235
FRP8.00-SS-NRS-G-BA	8"	1	384	\$21,458

REDUCED PRESSURE ZONE BACKFLOW PREVENTOR MEETS BUY AMERICA AND PSA STANDARDS

STAINLESS STEEL BODY AND NRS GATE VALVES FLANGED CONNECTIONS STRAINER ATTACHED				
Model Number	Size	Qty. per Carton	Weight per Carton (Lbs.)	List Price (Each)
FRP2.50-SS-NRS-S-BA	2/1/2"	1	139	\$5,484
FRP3.00-SS-NRS-S-BA	3"	1	158	\$5,837
FRP4.00-SS-NRS-S-BA	4"	1	213	\$6,522
FRP6.00-SSX-NRS-S-BA	6"	1	428	\$9,634
FRP8.00-SS-NRS-S-BA	8"	1	679	\$24,336

REDUCED PRESSURE ZONE BACKFLOW PREVENTOR MEETS BUY AMERICA AND PSA STANDARDS

STAINLESS STEEL BODY AND OSY GATE VALVES FLANGED CONNECTIONS				
Model Number	Size	Qty. per Carton	Weight per Carton (Lbs.)	List Price (Each)
FRP2.50-SS-OSY-BA	2 1/2"	1	124	\$5,144
FRP3.00-SS-OSY-BA	3"	1	148	\$5,370
FRP4.00-SS-OSY-BA	4"	1	169	\$5,967
FRP6.00-SSX-OSY-BA	6"	1	331	\$8,328
FRP8.00-SS-OSY-BA	8"	1	414	\$22,457

REDUCED PRESSURE ZONE BACKFLOW PREVENTOR MEETS BUY AMERICA AND PSA STANDARDS

STAINLESS STEEL BODY AND OSY GATE VALVES GROOVED CONNECTIONS				
Model Number	Size	Qty. per Carton	Weight per Carton (Lbs.)	List Price (Each)
FRP2.50-SS-OSY-G-BA	2 1/2"	1	119	\$5,144
FRP3.00-SS-OSY-G-BA	3"	1	142	\$5,370
FRP4.00-SS-OSY-G-BA	4"	1	159	\$5,967
FRP6.00-SSX-OSY-G-BA	6"	1	316	\$8,328
FRP8.00-SS-OSY-G-BA	8"	1	394	\$22,457

REDUCED PRESSURE ZONE BACKFLOW PREVENTOR MEETS BUY AMERICA AND PSA STANDARDS

STAINLESS STEEL BODY AND OSY GATE VALVES FLANGED CONNECTIONS STRAINER ATTACHED				
Model Number	Size	Qty. per Carton	Weight per Carton (Lbs.)	List Price (Each)
FRP2.50-SS-OSY-S-BA	2 1/2"	1	159	\$5,657
FRP3.00-SS-OSY-S-BA	3"	1	186	\$5,950
FRP4.00-SS-OSY-S-BA	4"	1	229	\$6,638
FRP6.00-SSX-OSY-S-BA	6"	1	461	\$9,989
FRP8.00-SS-OSY-S-BA	8"	1	689	\$24,519



2 1/2" thru 8"

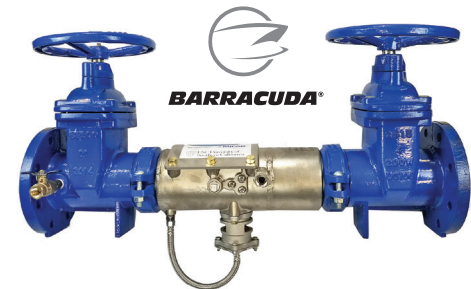

Function: The BEECO® Series Barracuda 40 REDUCED PRESSURE VALVE Backflow Prevention Valve prevents non-health hazard pollutants and hazardous contaminants from entering a potable water supply system when backpressure and/or backsiphonage conditions occur. This product is designed for the waterwork, plumbing, and irrigation markets only.

Sizes: 2 1/2", 3", 4", 6"(x), 8"

Working Pressure:
10-175psi (0.7-12.1 bar)

Temperature Range:
33°-140°F (1°-60°C)

Flanged Ends:
ANSI B16.1 Class 125

Lead Free: Patents:
0.25% Maximum by Weight

"As someone representing their products, MIFAB makes me feel like they are in the trenches with me. They are a partner who understands and supports us."

- Tom Babcock of Kast Marketing, Chicago, IL



Maximum working water pressure 150 PSI.
 Maximum working water temperature 140° F.
 Hydrostatic test pressure 300 PSI.

MATERIALS: Main valve body Cast Bronze
 ASTM B584, Fasteners Stainless Steel, 300 Series.

Elastomers Silicone (FDA approved) , Buna Nitrile (FDA approved), Polymers Polypropylene (FDA approved).

Delrin® (FDA approved), Springs Stainless Steel, 300 series.

“Plumbers like Beeco products It’s comparable with the competitors product and a great product well-made works well”

- Terry Zhang,
L.C. Plumbing & Electrical Supply

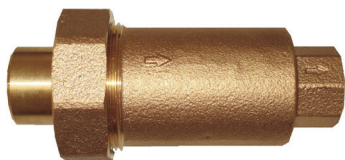

DC.50-NPTX.50-NPT-LL (ILLUSTRATED)
 FOR SPEC. SHEETS GO TO
www.beecobackflow.com



DC.75-SWTX.75-NPT-LL (ILLUSTRATED)
 FOR SPEC. SHEETS GO TO
www.beecobackflow.com

DC SERIES

DUAL CHECK VALVES
 IN LINE DOUBLE CHECK VALVE. DUAL CHECK VALVES LOW LEAD.
 IN LINE DOUBLE CHECK VALVE CONFORMS WITH AB 1953

FEMALE NPT BY FEMALE NPT

Model Number	Size	Qty. per Carton	Weight per Carton (Lbs.)	List Price (Each)
DC.50-NPTX.50-NPT-LL	1/2"	1	1.5	\$79
DC.75-NPTX.75-NPT-LL	3/4"	1	1.6	\$79
DC1.0-NPTX.75-NPT-LL	1" Inlet by 3/4"	1	1.7	\$83
DC1.0-NPTX1.0-NPT-LL	1"	1	2	\$85

DUAL CHECK VALVES LOW LEAD
 IN LINE DOUBLE CHECK VALVE CONFORMS WITH AB 1953

FEMALE SWT INLET BY FEMALE NPT

Model Number	Size	Qty. per Carton	Weight per Carton (Lbs.)	List Price (Each)
DC.50-SWTX.50-NPT-LL	1/2"	1	1.5	\$79
DC.75-SWTX.75-NPT-LL	3/4"	1	1.6	\$79
DC1.0-SWTX.75-NPT-LL	1" Inlet by 3/4"	1	1.7	\$83
DC1.0-SWTX1.0-NPT-LL	1"	1	2	\$85

DUAL CHECK VALVES LOW LEAD
 IN LINE DOUBLE CHECK VALVE CONFORMS WITH AB 1953

FEMALE IPS INLET BY FEMALE WATER METER CONNECTION

Model Number	Size	Qty. per Carton	Weight per Carton (Lbs.)	List Price (Each)
DC.75-FWMX.75-NPT-LL	3/4"	1	1.5	\$83
DC.75-FWMX1.0-NPT-LL	1"	1	1.5	\$85
DC1.0-FWMX.75-NPT-LL	3/4"	1	1.6	\$85
DC1.25-FWMX-1.0-NPT-LL	1"	1	2	\$109

AG SERIES

AIR GAPS FOR FRP VALVES

AIR GAPS FOR RELIEF VALVES				
Model Number	Size	Qty. per Carton	Weight per Carton (Lbs.)	List Price (Each)
AG1.00	1/2" thru 1"	1	2	\$ 60
AG2.00	1 1/4" thru 2"	1	3	\$ 68
AG6.00	2 1/2" thru 6"	1	5	\$ 78
AG6.00-90	2 1/2" thru 6"	1	5	\$ 49
AG10.00	8" and 10"	1	8	\$ 97
AG10.00-90	8" and 10"	1	8	\$ 67



AG1.00 (ILLUSTRATED)
FOR SPEC. SHEETS GO TO
www.beecobackflow.com

FUNCTION: BEECO Air Gaps provides the unobstructed, physical separation between the discharge end of a potable water supply line and an open receiving vessel.

MATERIAL: The BEECO Air Gaps are made of cast iron and fused bonded epoxy coating to keep them rust free.

AIR GAPS FOR BARRACUDA 40 FRP SERIES				
Model Number	Size	Qty. per Carton	Weight per Carton (Lbs.)	List Price (Each)
AG4.00-SS	2 1/2" thru 4"	1	2	\$ 196
AG8.00-SS	8" and 10"	1	3	\$ 236

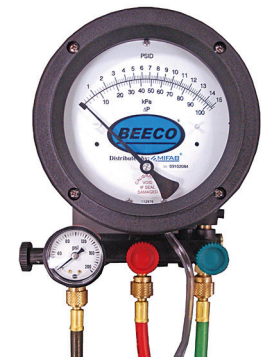

TK5-BACKFLOW-TEST (ILLUSTRATED)
FOR SPEC. SHEETS GO TO
www.beecobackflow.com

Call factory for lead times on backflow preventer enclosures.

TK SERIES

BACKFLOW PREVENTER TEST KITS

Model Number	Size	Qty. per Carton	Weight per Carton (Lbs.)	List Price (Each)
TK5-BACKFLOW-TEST	ALL	1	10	\$ 2,500

SPECIFICATION: Gauge

TYPE: Diaphragm Differential Pressure,

DIFFERENTIAL PRESSURE ACCURACY: ±0.2 P.S.I.D. (Descending),

WORKING PRESSURE: 200 P.S.I.G.

FUNCTION: The BEECO Test Kit is a compact portable device made for testing, reduced pressure zone assemblies, and double check valve assemblies, pressure vacuum breakers, and anti-spill vacuum breakers.

TEMPERATURE LIMITATIONS: Maximum 150°F/65°C.

FREEZING TEMPERATURES MUST BE AVOIDED!

"Thanks to your catalogue, we find it easy to navigate the pages and place an order. The detailed information shown there helps us to match the size of the unit for replacement of existing grease traps. The plastic grease trap distribution program is very user friendly and has helped to increase our sales dramatically."

- Bill Cornwell,
Manager, Bucks Wholesale Supply, Tampa, FL

RATINGS: 2 1/2" - 4" 750 P.S.I., 5" - 6" 700 P.S.I. 8" 600 P.S.I., 10" 500 P.S.I., 12" 400 P.S.I. Reducing Couplings 300 P.S.I.

GASKET:

MATERIAL: EPDM Temperature Rating: -30°C to +110°C; -20°F to +230°F. Applications: Water, diluted acids, oil free air, waste, high temperature vapors, etc.

DESIGN: "C" Type Gasket standard design, provides a pressure responsive, leak-tight seal in both pressure and vacuum applications without the aid of external forces.

Ductile cast iron conforming to ASTM A536, Grade 65-45-12 equal to QT 450-12. Surface Finish: Standard dip painted.

Optional fused bonded epoxy coated in various colors. Vacuum applications without the aid of external forces.



SP6.00 (ILLUSTRATED)
FOR SPEC. SHEETS GO TO
www.beecobackflow.com

BEECO Spools and Spacers are designed for retrofitting backflow prevention assemblies, Automatic Control Valves or other piping system installations into spaces where a longer lay length exists. Spools are available in fused bonded epoxy coated carbon steel and come standard with AWWA 150# class "D" carbon steel flanges.

REPLACEMENT CHECKS FOR BARRACUDA VALVES

REPLACEMENT CHECKS FOR BARRACUDA VALVES				
Model Number	Size	Qty. per Carton	Weight per Carton (Lbs.)	List Price (Each)
FRP4.00-SS-CHECK-1ST	2 1/2"-4"	1	2	\$716.00
FRP4.00-SS-CHECK-2ND	2 1/2"-4"	1	2	\$884.00
FDC4.00-SS-CHECK-1ST	2 1/2"-4"	1	2	\$716.00
FDC4.00-SS-CHECK-2ND	2 1/2"-4"	1	2	\$884.00
FRP8.00-SS-CHECK-1ST	6"-8"	1	4	\$1,596.00
FRP8.00-SS-CHECK-2ND	6"-8"	1	4	\$1,412.00
FDC8.00-SS-CHECK-1ST	6"-8"	1	4	\$1,412.00
FDC8.00-SS-CHECK-2ND	6"-8"	1	4	\$1,412.00

RUBBER REPAIR KITS FOR BARACUDA VALVES

Model Number	Size	Qty. per Carton	Weight per Carton (Lbs.)	List Price (Each)
FDC-FRP4.0-SS-RUBKIT	2 1/2"-4"	1	1	\$304.00
FDC-FRP8.0-SS-RUBKIT	6"-8"	1	1	\$572.00
FRP2-8-SS-RELIEF-KIT	2 1/2"-8"	1	2	\$476.00
FRP4.00-SS-REL-VLV	2 1/2"-4"	1	2	\$1,724.00
FRP8.00-SS-REL-VLV	6"-8"	1	2	\$1,724.00

SPOOLS AND SPACERS

DUAL FLANGED PIPE SPACERS MADE TO FIT YOUR APPLICATION

RIGID PIPE COUPLINGS				
Model Number	Size	Qty. per Carton	Weight per Carton (Lbs.)	List Price (Each)
SP2.50	2 1/2"	1		\$1,150
SP3.00	3"	1		\$1,304
SP4.00	4"	1		\$2,042
SP6.00	6"	1		\$3,260
SP8.00	8"	1		\$4,462
SP10.00	10"	1		\$5,663

FDC-RK SERIES

REPAIR KITS & PARTS FOR DOUBLE CHECK BACKFLOW PREVENTERS

ALL RUBBER SEATS AND SEALS				
Model Number	Size	Qty. per Carton	Weight per Carton (Lbs.)	List Price (Each)
FDC.75-RUBBER-KIT	1/2", 3/4"	1	1	\$28
FDC1.00-RUBBER-KIT	1"	1	1	\$34
FDC1.50-RUBBER-KIT	1 1/4", 1 1/2"	1	1	\$41
FDC2.00-RUBBER-KIT	2"	1	1	\$53
FDC4.00-RUBBER-KIT	2 1/2", 3", 4"	1	1	\$242
FDC6.00-RUBBER-KIT	6"	1	1	\$292
FDC10.00-RUBBER-KIT	8", 10"	1	1	\$431

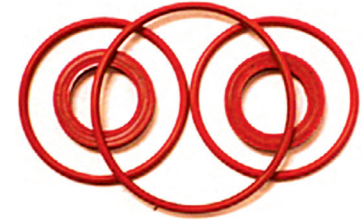

FDC2.00-RUBBER-KIT (ILLUSTRATED)

REPLACEMENT CHECK				
Model Number	Size	Qty. per Carton	Weight per Carton (Lbs.)	List Price (Each)
FDC.75-CHECK	1/2", 3/4"	1	1	\$31
FDC1.00-CHECK	1"	1	1	\$70
FDC1.50-CHECK	1 1/4", 1 1/2"	1	1	\$127
FDC2.00-CHECK	2"	1	1	\$140
FDC4.00-CHECK	2 1/2", 3", 4"	1	1	\$661
FDC6.00-CHECK	6"	1	1	\$1,072
FDC10.00-CHECK	8", 10"	1	1	\$1,661



FDC2.00-CHECK (ILLUSTRATED)

FRP-RK SERIES

KITS FOR REDUCED PRESSURE ZONE BACKFLOW PREVENTERS

ALL RUBBER SEATS AND SEALS EXCEPT RELIEF VALVE				
Model Number	Size	Qty. per Carton	Weight per Carton (Lbs.)	List Price (Each)
FRP.75-RUBBER-KIT	1/2", 3/4"	1	1	\$26
FRP1.00-RUBBER-KIT	1"	1	1	\$31
FRP2.00-RUBBER-KIT	1 1/4", 1 1/2", 2"	1	1	\$38
FRP4.00-RUBBER-KIT	2 1/2", 3", 4"	1	1	\$233
FRP6.00-RUBBER-KIT	6"	1	1	\$281
FRP10.00-RUBBER-KIT	8", 10"	1	1	\$414



FRP2.00-RUBBER-KIT (ILLUSTRATED)

FRP1.00-RV-KIT (ILLUSTRATED)

"The Beeco Backflow is very easy to service and the repair parts are very reasonably priced."

- Frank Paulette, Correct Mechanical

FRP2.00-CHECK-1ST (ILLUSTRATED)

FRP4.00-CHECK-2ND (ILLUSTRATED)
ALL RUBBER SEATS AND SEALS, RELIEF VALVE ONLY

Model Number	Size	Qty. per Carton	Weight per Carton (Lbs.)	List Price (Each)
FRP1.00-RV-KIT	1/2", 3/4", 1"	1	1	\$50
FRP2.00-RV-KIT	1 1/4", 1 1/2", 2"	1	1	\$59
FRP6.00-RV-KIT	2 1/2", 3", 4", 6"	1	1	\$269
FRP10.00-RV-KIT	8", 10"	1	1	\$414

REPLACEMENT FOR FIRST CHECK

Model Number	Size	Qty. per Carton	Weight per Carton (Lbs.)	List Price (Each)
FRP.75-CHECK-1ST	1/2", 3/4"	1	1	\$36
FRP1.00-CHECK-1ST	1"	1	1	\$68
FRP2.00-CHECK-1ST	1 1/4", 1 1/2", 2"	1	1	\$134
FRP4.00-CHECK-1ST	2 1/2", 3", 4"	1	3	\$677
FRP6.00-CHECK-1ST	6"	1	5	\$1,168
FRP10.00-CHECK-1ST	8", 10"	1	7	\$1,662

PLASTIC REPLACEMENT PARTS FOR RELIEF VALVES

Model Number	Size	Weight per Carton (Lbs.)	List Price (Each)
FRP1.00-RV-PARTS	1/2", 3/4", 1"	1	\$49
FRP2.00-RV-PARTS	1 1/4", 1 1/2", 2"	1	\$58
FRP6.00-RV-PARTS	2 1/2", 3", 4", 6"	2	\$86

REPLACEMENT BACKFLOW CHECKS
REPLACEMENT FOR SECOND CHECK

Model Number	Size	Qty. per Carton	Weight per Carton (Lbs.)	List Price (Each)
FRP.75-CHECK-2ND	1/2", 3/4"	1	1	\$31
FRP1.00-CHECK-2ND	1"	1	1	\$70
FRP2.00-CHECK-2ND	1 1/4", 1 1/2", 2"	1	1	\$127
FRP4.00-CHECK-2ND	2 1/2", 3", 4"	1	3	\$661
FRP6.00-CHECK-2ND	6"	1	5	\$1,072
FRP10.00-CHECK-2ND	8", 10"	1	7	\$1,661

OLD HERSEY BEECO REPAIR KITS

RUBBER REPAIR KITS. OLD STYLE HERSEY BEECO BACKFLOW PREVENTERS

RUBBER REPAIR KIT, FDC MODEL (2006 AND PRIOR)				
Model Number	Size	Qty. per Carton	Weight per Carton (Lbs.)	List Price (Each)
65671-FDC-BASIC-KIT	3/4"&1"	1	1	\$132
65672-FDC-BASIC-KIT	1 1/2"	1	1	\$194
65673-FDC-BASIC-KIT	2"	1	1	\$210



65673-FDC-BASIC-KIT (ILLUSTRATED)

RUBBER REPAIR KIT, FDC MODEL 2 AND DDC II MODEL (2006 AND PRIOR)				
Model Number	Size	Qty. per Carton	Weight per Carton (Lbs.)	List Price (Each)
63351-FDC-RUB-KIT	3"	1	1	\$448
63451-FDC-RUB-KIT	4"	1	1	\$613
63651-FDC-RUB-KIT	6"	1	1	\$723
63851-FDC-RUB-KIT	8"	1	1	\$1,384
63951-FDC-RUB-KIT	10"	1	1	\$3,985



63351-FDC-RUB-KIT (ILLUSTRATED)

RUBBER REPAIR KIT, FRP II (2006 AND PRIOR)				
Model Number	Size	Qty. per Carton	Weight per Carton (Lbs.)	List Price (Each)
65668-FRP-II-RUB-KIT	3/4"&1"	1	1	\$152
65669-FRP-II-RUB-KIT	1 1/4" & 1 1/2"	1	1	\$205
65670-FRP-II-RUB-KIT	2"	1	1	\$221



65668-FRP-II-RUB-KIT (ILLUSTRATED)

63543-CI-6CM-RUB-KIT (ILLUSTRATED)

RUBBER REPAIR KIT, FRP #6CM CAST IRON DESIGN (2006 AND PRIOR)				
Model Number	Size	Qty. per Carton	Weight per Carton (Lbs.)	List Price (Each)
63543-CI-6CM-RUB-KIT	2 1/2"	1	1	\$754
63350-CI-6CM-RUB-KIT	3"	1	1	\$782
63450-CI-6CM-RUB-KIT	4"	1	1	\$926
63650-CI-6CM-RUB-KIT	6"	1	1	\$1,271
63850-CI-6CM-RUB-KIT	8"	1	1	\$1,833
63950-CI-6CM-RUB-KIT	10"	1	1	\$4,381

63550-BRZ-6CM-KIT (ILLUSTRATED)

RUBBER REPAIR KIT, FRP #6CM BRONZE DESIGN (2006 AND PRIOR)				
Model Number	Size	Qty. per Carton	Weight per Carton (Lbs.)	List Price (Each)
63550-BRZ-6CM-KIT	2 1/2"	1	1	\$729
63343-BRZ-6CM-KIT	3"	1	1	\$744
63443-BRZ-6CM-KIT	4"	1	1	\$793
63643-BRZ-6CM-KIT	6"	1	1	\$1,239

61231-CI-6C-RUB-KIT (ILLUSTRATED)

RUBBER REPAIR KIT, FRP 6C CAST IRON DESIGN (2006 AND PRIOR)				
Model Number	Size	Qty. per Carton	Weight per Carton (Lbs.)	List Price (Each)
61231-CI-6C-RUB-KIT	6"	1	1	\$899
61233-CI-6C-RUB-KIT	8"	1	1	\$2,280
61234-CI-6C-RUB-KIT	10"	1	1	\$3,114

61225-BRZ-6C-RUB-KIT (ILLUSTRATED)

RUBBER REPAIR KIT, FRP 6C BRONZE DESIGN (2006 AND PRIOR)				
Model Number	Size	Qty. per Carton	Weight per Carton (Lbs.)	List Price (Each)
61225-BRZ-6C-RUB-KIT	1"	1	1	\$457
61226-BRZ-6C-RUB-KIT	1 1/2"	1	1	\$495
61227-BRZ-6C-RUB-KIT	2"	1	1	\$543
61228-BRZ-6C-RUB-KIT	2 1/2"	1	1	\$603
61229-BRZ-6C-RUB-KIT	3"	1	1	\$633
61230-BRZ-6C-RUB-KIT	4"	1	1	\$672
61232-BRZ-6C-RUB-KIT	6"	1	1	\$867

MI-CONTROL SERIES

Model Number	Size	Qty. per Carton	Weight per Carton (Lbs.)	List Price (Each)
MI-CONTROL-LL	3/4"	20	21	\$ 68
MI-CONTROL-LL-CP	3/4"	20	21	\$ 68

Note: -CP is a 3/8" Compression fitting.

NPT CONNECTIONS ADJUSTABLE FROM 80PSI TO 150PSI RELIEF

Model Number	Size	Qty. per Carton	Weight per Carton (Lbs.)	List Price (Each)
MI-CONTROL-NPT-LL	3/4"	20	25	\$ 68

PEX CONNECTIONS ADJUSTABLE FROM 80PSI TO 150PSI RELIEF

Model Number	Size	Qty. per Carton	Weight per Carton (Lbs.)	List Price (Each)
MI-CONTROL-PEX-LL	3/4"	20	25	\$ 71

SWEAT CONNECTIONS ADJUSTABLE FROM 80PSI TO 150PSI RELIEF

Model Number	Size	Qty. per Carton	Weight per Carton (Lbs.)	List Price (Each)
MI-CONTROL-SWT-LL	3/4"	20	25	\$ 68

CV SERIES

BRONZE SILENT CHECK VALVE THREADED CONNECTIONS

Model Number	Size	Qty. per Carton	Weight per Carton (Lbs.)	List Price (Each)
CV.25-IPS-LL	1/4"	20	10	\$ 22
CV.375-IPS-LL	3/8"	20	12	\$ 22
CV.50-IPS-LL	1/2"	20	14	\$ 22
CV.75-IPS-LL	3/4"	20	16	\$ 44
CV1.00-IPS-LL	1"	20	24	\$ 55

BRONZE SILENT CHECK VALVE SWEAT CONNECTIONS

Model Number	Size	Qty. per Carton	Weight per Carton (Lbs.)	List Price (Each)
CV.50-SWT-LL	1/2"	20	14	\$ 22
CV.75-SWT-LL	3/4"	20	16	\$ 44
CV1.00-SWT-LL	1"	20	24	\$ 66

ASVB SERIES

ANTI-SIPHON VACUUM BREAKER.

BRASS BODY DESIGN

Model Number	Size	Qty. per Carton	Weight per Carton (Lbs.)	List Price (Each)
ASVB.25-B-LL	1/4"	24	10	\$ 28
ASVB.375-B-LL	3/8"	24	10	\$ 28
ASVB.50-B-LL	1/2"	16	8	\$ 35
ASVB.75-B-LL	3/4"	16	12	\$ 43

CHROME PLATED BODY DESIGN

Model Number	Size	Qty. per Carton	Weight per Carton (Lbs.)	List Price (Each)
ASVB.25-CP-LL	1/4"	24	10	\$ 40
ASVB.375-CP-LL	3/8"	24	10	\$ 40
ASVB.50-CP-LL	1/2"	16	8	\$ 48
ASVB.75-CP-LL	3/4"	16	12	\$ 58



MI-CONTROL-LL (ILLUSTRATED)

FOR SPEC. SHEETS GO TO www.beecobackflow.com

"The unique riser systems on the MIFAB plastic interceptor line makes our installations quick and easy."

- Larry Medlen, Project Manager, Rock City Mechanical, Nashville, TN

Under CV add maximum working pressure 400 psi (27.6 bars); temperature rating -20° to 100° F (-29° C to 38° C). Maximum temperature rating is 400° F.

Under ASVB add maximum temperature 180°F (82°C); maximum working pressure 125 psi (8.6 bar).

BEECO's Anti-Siphon Vacuum Breaker is designed to meet the requirements of ASSE Standard 1001, CSA B64 and ANSI A112.1.1. Device must be installed 6" above the highest point of the downstream piping. There can be no shutoff devices downstream of the ASVB.



CV1.00-IPS-LL (ILLUSTRATED)

FOR SPEC. SHEETS GO TO www.beecobackflow.com



ASVB.75-B-LL (ILLUSTRATED)

FOR SPEC. SHEETS GO TO www.beecobackflow.com



APPROVALS:

Tested and certified to A.S.S.E. Standard 1015, CSA B64.5 and listed with IAPMO.



HVB.75-X.75M-RB-LL (ILLUSTRATED)
FOR SPEC. SHEETS GO TO
www.beecobackflow.com



HBVBSD.75-RB-LL (ILLUSTRATED)
FOR SPEC. SHEETS GO TO
www.beecobackflow.com



STR2.50-IRON-FLG (ILLUSTRATED)
FOR SPEC. SHEETS GO TO
www.beecobackflow.com

The ductile iron "Y" type strainer shall be in 125 class and conform to ANSI B16.1, and both the body and access cover shall be made of ductile iron A536 65-45 12. The valve shall be supplied with a drain/blow-off valve with a ductile iron closure plug and will have an FDA approved epoxy coating inside and out. The integral strainer screen shall be accessible for cleaning without removing the device from the line.

BODY: Ductile Iron A536 65-45 12

COVER: Ductile Iron A536 65-45 12

GASKET: Teflon/Graphite Standard

SCREEN: 304 Stainless Steel working pressure PN16/Class 125. Temperatures to 270° F (120° C).



STR6.00-IRON-FLG-PC (ILLUSTRATED)
FOR SPEC. SHEETS GO TO
www.beecobackflow.com

HBVB SERIES

HOSE CONNECTION VACUUM BREAKERS

HOSE CONNECTION ATMOSPHERIC VACUUM BREAKER

Model Number	Size	Qty. per Carton	Weight per Carton (Lbs.)	List Price (Each)
HVB.75F-X-.75M-RB-LL	3/4"	1	1	\$14
HVB.75F-X-.75M-CP-LL	3/4"	1	1	\$15

SELF DRAINING HOSE VACUUM BREAKER

Model Number	Size	Qty. per Carton	Weight per Carton (Lbs.)	List Price (Each)
HBVBSD.75-CP-LL	3/4"	1	1	\$32
HBVBSD.75-RB-LL	3/4"	1	1	\$30

STR-DI-SERIES

DUCTILE IRON STRAINERS

FLANGED (200WOG-125WSP), ANSI 125 WITH TAPPED CLOSURE PLUG

Model Number	Size	Qty. per Carton	Weight per Carton (Lbs.)	List Price (Each)
STR2.00-IRON-FLG	2"	1	20	\$196
STR2.50-IRON-FLG	2 1/2"	1	35	\$283
STR3.00-IRON-FLG	3"	1	38	\$355
STR4.00-IRON-FLG	4"	1	65	\$452
STR6.00-IRON-FLG	6"	1	150	\$1,021
STR8.00-IRON-FLG	8"	1	275	\$1,509
STR10.00-IRON-FLG	10"	1	410	\$2,620
STR12.00-IRON-FLG	12"	1	600	\$4,399

STR-DI-PC SERIES

FLANGED (200WOG-125WSP), ANSI 125 WITH TAPPED CLOSURE PLUG FUSED EPOXY POWDER COATED

Model Number	Size	Qty. per Carton	Weight per Carton (Lbs.)	List Price (Each)
STR2.00-IRON-FLG-PC	2"	1	22	\$303
STR2.50-IRON-FLG-PC	2 1/2"	1	35	\$342
STR3.00-IRON-FLG-PC	3"	1	38	\$466
STR4.00-IRON-FLG-PC	4"	1	65	\$548
STR6.00-IRON-FLG-PC	6"	1	150	\$1,146
STR8.00-IRON-FLG-PC	8"	1	275	\$1,719
STR10.00-IRON-FLG-PC	10"	1	410	\$3,100
STR12.00-IRON-FLG-PC	12"	1	600	\$4,619

STR-IPS-LL SERIES

LOW LEAD CALIFORNIA AB 1953 COMPLIANT. BRONZE STRAINERS

WYE TYPE, THREADED CONNECTIONS				
Model Number	Size	Qty. per Carton	Weight per Carton (Lbs.)	List Price (Each)
STR.50-IPS-BRZ-LL	1/2"	12	7	\$34
STR.75-IPS-BRZ-LL	3/4"	8	7	\$53
STR1.00-IPS-BRZ-LL	1"	8	11	\$83
STR1.25-IPS-BRZ-LL	1 1/4"	6	13	\$124
STR1.50-IPS-BRZ-LL	1 1/2"	2	6	\$188
STR2.00-IPS-BRZ-LL	2"	2	12	\$329

STR-SWT-LL SERIES

WYE TYPE, SWEAT CONNECTIONS				
Model Number	Size	Qty. per Carton	Weight per Carton (Lbs.)	List Price (Each)
STR.50-SWT-BRZ-LL	1/2"	12	7	\$34
STR.50-SWT-BRZ-LL-.25	1/2"	12	7	\$36
STR.75-SWT-BRZ-LL	3/4"	8	7	\$53
STR.75-SWT-BRZ-LL-.25	3/4"	8	7	\$55
STR1.00-SWT-BRZ-LL	1"	8	11	\$83
STR1.25-SWT-BRZ-LL	1 1/4"	6	13	\$124
STR1.50-SWT-BRZ-LL	1 1/2"	2	6	\$171
STR2.00-SWT-BRZ-LL	2"	2	12	\$300

NOTE: .25 SUFFIX MEANS THE DRAIN PLUG ON THE STRAINER CAP IS 1/4" NPT ALL OTHER STRAINERS HAVE A STANDARD CLEAN OUT PLUG THAT IS 3/8" NPT.

BV-IPS-BRZ SERIES

BRONZE NO LEAD BALL VALVES LOW LEAD CALIFORNIA AB 1953 COMPLIANT

THREADED CONNECTIONS				
Model Number	Size	Qty. per Carton	Weight per Carton (Lbs.)	List Price (Each)
BV.50-IPS-BRZ-LL	1/2"	6	6	\$25
BV.75-IPS-BRZ-LL	3/4"	6	8	\$34
BV1.00-IPS-BRZ-LL	1"	2	4	\$72
BV1.25-IPS-BRZ-LL	1 1/4"	2	6	\$77
BV1.50-IPS-BRZ-LL	1 1/2"	2	8	\$113
BV2.00-IPS-BRZ-LL	2"	1	6	\$190



STR.50-SWT-BRZ-LL (ILLUSTRATED)

FOR SPEC. SHEETS GO TO www.beecobackflow.com

The "Y" type strainer shall be a NO-LEAD strainer with a brass cap and a stainless steel mess screen. The valve shall be designed so the screen can be cleaned without removal of the valve from the pipe line and shall be equipped with a enclosure plug in the brass clean out cap for the addition of a test gauge or secondary water line.

BRONZE BODY: Standard NO-LEAD

RETAINER CAP: Brass Cap Gasket: NBR
STANDARD SCREEN: 304 Stainless Steel 20 Mesh

MAXIMUM WORKING PRESSURE:
400 P.S.I. (27.6 bar) WOG @ 210° F (99° C)

"We really like the C-PORT products. MIFAB overall has a great product offering with a wide selection. I have not had any issues with using MIFAB on a job. Also, the local representative is great!"

- Mike Bright, Arizona Pinnacle Engineering



BV.50-IPS-BRZ-LL (ILLUSTRATED)

FOR SPEC. SHEETS GO TO www.beecobackflow.com



BV.50-IPS-BRZ-SH-LL (ILLUSTRATED)
FOR SPEC. SHEETS GO TO
www.beecobackflow.com

"The convenience of a local stocking warehouse is a great incentive to sell"

- Tim Galbally, Pennypack Plumbing Supply

The BEECO Full Port Ball Valve is a two piece Bronze Ball Valve with a chrome plated ball. The valve has a blow out proof stem with adjustable packing. Its full port design eliminates the significant pressure losses caused by standard reduced port valves.

The BEECO Full Port Ball Valve is used in commercial and industrial applications on a wide variety of liquids and gases.

Each valve is 100 percent factory tested; standard options are locking handle, Stainless Steel Handle and stainless steel handle nut. Blow out proof pressure retaining stem, adjustable stem packing, heavy duty handle with slip resistant vinyl insulator.

600 WOG and 150 SWP. Conforms to Federal Specification WW-V-35, Type II class A, Style 3 & MSS SP-110. Temperature Range 0° F to 450° F.



BV1.00-IPS-BRZ-LH-LL (ILLUSTRATED)
FOR SPEC. SHEETS GO TO
www.beecobackflow.com



BV.50-SWT-BRZ-SH-LL (ILLUSTRATED)
FOR SPEC. SHEETS GO TO
www.beecobackflow.com

THREADED CONNECTIONS, STAINLESS STEEL HANDLES

Model Number	Size	Qty. per Carton	Weight per Carton (Lbs.)	List Price (Each)
BV.50-IPS-BRZ-SH-LL	1/2"	20	12	\$34
BV.75-IPS-BRZ-SH-LL	3/4"	20	22	\$44
BV1.00-IPS-BRZ-SH-LL	1"	12	25	\$80
BV1.25-IPS-BRZ-SH-LL	1 1/4"	6	18	\$96
BV1.50-IPS-BRZ-SH-LL	1 1/2"	6	24	\$131
BV2.00-IPS-BRZ-SH-LL	2"	6	28	\$215

THREADED CONNECTIONS, LOCKING HANDLES

Model Number	Size	Qty. per Carton	Weight per Carton (Lbs.)	List Price (Each)
BV.50-IPS-BRZ-LH-LL	1/2"	20	12	\$34
BV.75-IPS-BRZ-LH-LL	3/4"	20	22	\$44
BV1.00-IPS-BRZ-LH-LL	1"	12	25	\$80
BV1.25-IPS-BRZ-LH-LL	1 1/4"	6	18	\$96
BV1.50-IPS-BRZ-LH-LL	1 1/2"	6	24	\$131
BV2.00-IPS-BRZ-LH-LL	2"	6	28	\$215

BV-SWT-BRZ SERIES LOW LEAD BRONZE NO LEAD BALL VALVES. LOW LEAD CALIFORNIA AB 1953 COMPLIANT

SOLDER CONNECTIONS

Model Number	Size	Qty. per Carton	Weight per Carton (Lbs.)	List Price (Each)
BV.50-SWT-BRZ-LL	1/2"	20	12	\$26
BV.75-SWT-BRZ-LL	3/4"	20	22	\$35
BV1.00-SWT-BRZ-LL	1"	12	25	\$51
BV1.25-SWT-BRZ-LL	1 1/4"	6	18	\$79
BV1.50-SWT-BRZ-LL	1 1/2"	6	24	\$108
BV2.00-SWT-BRZ-LL	2"	6	28	\$193

SOLDER CONNECTIONS, STAINLESS STEEL HANDLES

Model Number	Size	Qty. per Carton	Weight per Carton (Lbs.)	List Price (Each)
BV.50-SWT-BRZ-SH-LL	1/2"	20	12	\$35
BV.75-SWT-BRZ-SH-LL	3/4"	20	22	\$44
BV1.00-SWT-BRZ-SH-LL	1"	12	25	\$59
BV1.25-SWT-BRZ-SH-LL	1 1/4"	6	18	\$97
BV1.50-SWT-BRZ-SH-LL	1 1/2"	6	24	\$113
BV2.00-SWT-BRZ-SH-LL	2"	6	28	\$210

SOLDER CONNECTIONS, LOCKING HANDLES				
Model Number	Size	Qty. per Carton	Weight per Carton (Lbs.)	List Price (Each)
BV.50-SWT-BRZ-LH-LL	1/2"	20	12	\$35
BV.75-SWT-BRZ-LH-LL	3/4"	20	22	\$44
BV1.00-SWT-BRZ-LH-LL	1"	12	25	\$59
BV1.25-SWT-BRZ-LH-LL	1 1/4"	6	18	\$97
BV1.50-SWT-BRZ-LH-LL	1 1/2"	6	24	\$113
BV2.00-SWT-BRZ-LH-LL	2"	6	28	\$210



PG2.50-0-160-BTM-25 (ILLUSTRATED)

FOR SPEC. SHEETS GO TO www.beecobackflow.com

PG-BTM SERIES

PRESSURE GAUGES

BOTTOM ENTRY PRESSURE GAUGES, 2 1/2" FACE, 1/4" NPT				
Model Number	Size	Qty. per Carton	Weight per Carton (Lbs.)	List Price (Each)
PG2.50-0-30-BTM-25	0-30	100	27	\$13
PG2.50-0-60-BTM-25	0-60	100	27	\$13
PG2.50-0-100-BTM-25	0-100	100	27	\$13
PG2.50-0-160-BTM-25	0-160	100	27	\$13
PG2.50-0-200-BTM-25	0-200	100	27	\$13
PG2.50-0-300-BTM-25	0-300	100	27	\$13

Gauges come in ranges from 0-30 psi up to 0-300 psi. In Top, Bottom and Back mounting options. In both 1/8" NPT and 1/4" NPT connections. Operating Temperatures Ambient -40°F to 140°F (-40°C to 60°C).

CLASS: F+ 3/2/3% (ASMA B40.100 Grade B), KI 2.5 FOR 1/1/2" & 2", KI 1.6 for 3" & 4" Vacuum compound 0 to 60psi Accuracy

BOTTOM ENTRY PRESSURE GAUGES, 4" FACE, 1/4" NPT				
Model Number	Size	Qty. per Carton	Weight per Carton (Lbs.)	List Price (Each)
PG4.00-0-30-BTM-25	0-30	50	34	\$26
PG4.00-0-60-BTM-25	0-60	50	34	\$26
PG4.00-0-100-BTM-25	0-100	50	34	\$26
PG4.00-0-160-BTM-25	0-160	50	34	\$26
PG4.00-0-200-BTM-25	0-200	50	34	\$26
PG4.00-0-300-BTM-25	0-300	50	34	\$26

PG-BK SERIES

CENTER BACK ENTRY PRESSURE GAUGES, 2" FACE, 1/4" NPT				
Model Number	Size	Qty. per Carton	Weight per Carton (Lbs.)	List Price (Each)
PG2.00-0-60-BK-.25	0-60	100	25	\$12
PG2.00-0-160-BK-.25	0-160	100	25	\$12



PG2.00-160-BK-25 (ILLUSTRATED)

FOR SPEC. SHEETS GO TO www.beecobackflow.com



PG2.00-160-BK-.125 (ILLUSTRATED)
FOR SPEC. SHEETS GO TO
www.beecobackflow.com



PG2.00-160-T-.125 (ILLUSTRATED)
FOR SPEC. SHEETS GO TO
www.beecobackflow.com

BEECO Pressure Gauges are designed for use in residential, commercial, industrial and HVAC applications.

Accuracy to ASME type B with a copper alloy NPT connection in various sizes and ratings. These are used for all suitable air and liquid systems for medium which does not clog connection ports or corrode copper alloy. Can be used in all water applications and can be used in both pneumatic systems and compressed air systems.



GV6.00-FXF-OSY (ILLUSTRATED)
FOR SPEC. SHEETS GO TO
www.beecobackflow.com

CENTER BACK ENTRY PRESSURE GAUGES, 2" FACE, 1/8" NPT

Model Number	Size	Qty. per Carton	Weight per Carton (Lbs.)	List Price (Each)
PG2.00-0-60-BK-.125	0-60	100	25	\$12
PG2.00-0-160-BK-.125	0-160	100	25	\$12

PG-TOP SERIES
TOP ENTRY PRESSURE GAUGES, 2" FACE, 1/4" NPT

Model Number	Size	Qty. per Carton	Weight per Carton (Lbs.)	List Price (Each)
PG2.00-0-60-T-.25	0-60	100	25	\$12
PG2.00-0-160-T-.25	0-160	100	25	\$12

TOP ENTRY PRESSURE GAUGES, 2" FACE, 1/8" NPT

Model Number	Size	Qty. per Carton	Weight per Carton (Lbs.)	List Price (Each)
PG2.00-0-60-T-.125	0-60	100	25	\$12
PG2.00-0-160-T-.125	0-160	100	25	\$12

GATE VALVE SERIES OSY STYLE
FLANGED BY FLANGED, OSY RESILIENT WEDGE, EPOXY COATED

Model Number	Size	Qty. per Carton	Weight per Carton (Lbs.)	List Price (Each)
GV2.50-FXF-OSY	2 1/2"	1	50	\$666
GV3.00-FXF-OSY	3"	1	60	\$850
GV4.00-FXF-OSY	4"	1	100	\$1,125
GV6.00-FXF-OSY	6"	1	160	\$1,792
GV8.00-FXF-OSY	8"	1	280	\$3,086
GV10.00-FXF-OSY	10"	1	440	\$4,695

GROOVED BY GROOVED, OSY RESILIENT WEDGE, EPOXY COATED				
Model Number	Size	Qty. per Carton	Weight per Carton (Lbs.)	List Price (Each)
GV2.50-GXG-OSY	2 1/2"	1	40	\$554
GV3.00-GXG-OSY	3"	1	50	\$668
GV4.00-GXG-OSY	4"	1	85	\$886
GV6.00-GXG-OSY	6"	1	135	\$1,415
GV8.00-GXG-OSY	8"	1	220	\$2,443
GV10.00-GXG-OSY	10"	1	380	\$3,721



GV4.00-GXG-OSY (ILLUSTRATED)

FOR SPEC. SHEETS GO TO www.beecobackflow.com

The BEECO® Series GV-FXF-OSY is a Flanged by Flanged OS&Y (Outside Screw and Yoke) Resilient Seated Gate Valve. It is manufactured in compliance with AWWA C515 Standard. Flanges are to ANSI B16.1, Class 125 drilling pattern. The body, bonnet, and wedge (disc) are of high strength ductile-iron, ASTM A536, Grade 65-45-12. The wedge is encapsulated with EPDM rubber. The stem and bolts are of stainless steel.

Function: Used in irrigation and water distribution systems as main shut off valves. The BEECO Series GV-FXF-OSY is best used in the fully opened or fully closed position, but can be used as a throttling valve as required.

Features:

- UL Listed / FM Approved at 300 P.S.I. (20.8 bar) water working pressure rating.
- Fusion Bonded Interior and Exterior to AWWA C550 Standard.
- Pre-Grooved Stems for Installation of Tamper Switch.
- Complies with MSS SP-70 Standard.

GROOVED BY GROOVED, OSY, UL & FM APPROVED				
Model Number	Size	Qty. per Carton	Weight per Carton (Lbs.)	List Price (Each)
GV2.50-GXG-UL-OSY	2 1/2"	1	50	\$872
GV3.00-GXG-UL-OSY	3"	1	60	\$989
GV4.00-GXG-UL-OSY	4"	1	100	\$1,311
GV6.00-GXG-UL-OSY	6"	1	160	\$1,993
GV8.00-GXG-UL-OSY	8"	1	240	\$3,058
GV10.00-GXG-UL-OSY	10"	1	400	\$4,952

FLANGED BY FLANGED, OSY, UL & FM APPROVED				
Model Number	Size	Qty. per Carton	Weight per Carton (Lbs.)	List Price (Each)
GV2.50-FXF-UL-OSY	2 1/2"	1	50	\$1,089
GV3.00-FXF-UL-OSY	3"	1	60	\$1,156
GV4.00-FXF-UL-OSY	4"	1	100	\$1,361
GV6.00-FXF-UL-OSY	6"	1	160	\$2,046
GV8.00-FXF-UL-OSY	8"	1	280	\$3,303
GV10.00-FXF-UL-OSY	10"	1	440	\$5,084

"You can see and feel our business grow because of MIFAB."

- Dan Thomas of Ben Thomas and Associates, Shade Gap, PA

FLANGED BY GROOVED, OSY, UL & FM APPROVED				
Model Number	Size	Qty. per Carton	Weight per Carton (Lbs.)	List Price (Each)
GV2.50-FXG-UL-OSY	2 1/2"	1	45	\$894
GV3.00-FXG-UL-OSY	3"	1	55	\$999
GV4.00-FXG-UL-OSY	4"	1	90	\$1,338
GV6.00-FXG-UL-OSY	6"	1	145	\$2,016
GV8.00-FXG-UL-OSY	8"	1	260	\$3,168
GV10.00-FXG-UL-OSY	10"	1	420	\$4,992



GV6.00-FXF-UL-OSY (ILLUSTRATED)

FOR SPEC. SHEETS GO TO www.beecobackflow.com



**USC
APPROVED**
2 1/2" thru 6"

GV3.00-FXG-NRS (ILLUSTRATED)
FOR SPEC. SHEETS GO TO
www.beecobackflow.com

The BEECO® Series GV-FXF-NRS is an AWWA C515 flange x flange resilient seated gate valve with a non-rising stem. Flanges are to ANSI B16.1, Class 125 drilling pattern. The body, bonnet, and wedge (disc) are of high strength ductile iron, ASTM A536, Grade 65-45-12. The wedge is encapsulated with EPDM rubber. The stem and bolts are of stainless steel.

Function: Used in irrigation and water distribution. The BEECO® Series GV-FXF-NRS is best used in the fully opened or fully closed position but can be used as a throttling valve.

Features:

- Available with Handwheel or Operating Nut.
- 300 P.S.I. (20.8 bar) water working pressure rating.
- Fusion Bonded Interior and Exterior to AWWA C550 Standard.

Ratings:

- Stems are heat treated stainless steel, more than twice as strong as brass stems. Highest working pressure rating of any valve in its class 100% of all valves are hydrostatically tested at 2 x full rated working pressure. Proof of design tests include 5x working pressure and 1000 cycle tests. Temperature rated up to 180° F. (82° C)



GV2.50-FXF-NRS (ILLUSTRATED)
FOR SPEC. SHEETS GO TO
www.beecobackflow.com

FLANGED BY GROOVED, OSY RESILIENT WEDGE, EPOXY COATED

Model Number	Size	Qty. per Carton	Weight per Carton (Lbs.)	List Price (Each)
GV2.50-FXG-OSY	2 1/2"	1	45	\$666
GV3.00-FXG-OSY	3"	1	55	\$850
GV4.00-FXG-OSY	4"	1	90	\$1,125
GV6.00-FXG-OSY	6"	1	145	\$1,792
GV8.00-FXG-OSY	8"	1	240	\$3,086
GV10.00-FXG-OSY	10"	1	400	\$4,695

GATE VALVE SERIES NRS STYLE

GATE VALVES FLANGED BY GROOVED SERIES

FLANGED BY GROOVED, NRS RESILIENT WEDGE, EPOXY COATED

Model Number	Size	Qty. per Carton	Weight per Carton (Lbs.)	List Price (Each)
GV2.50-FXG-NRS	2 1/2"	1	40	\$569
GV3.00-FXG-NRS	3"	1	55	\$724
GV4.00-FXG-NRS	4"	1	80	\$961
GV6.00-FXG-NRS	6"	1	140	\$1,527
GV8.00-FXG-NRS	8"	1	230	\$2,858
GV10.00-FXG-NRS	10"	1	365	\$3,996

GATE VALVES, CAST IRON C515 CLASS 150

FLANGED BY FLANGED, NRS RESILIENT WEDGE, EPOXY COATED

Model Number	Size	Qty. per Carton	Weight per Carton (Lbs.)	List Price (Each)
GV2.00-FXF-NRS	2"	1	33	\$521
GV2.50-FXF-NRS	2 1/2"	1	37	\$569
GV3.00-FXF-NRS	3"	1	44	\$724
GV4.00-FXF-NRS	4"	1	57	\$961
GV6.00-FXF-NRS	6"	1	101	\$1,527
GV8.00-FXF-NRS	8"	1	154	\$2,858
GV10.00-FXF-NRS	10"	1	231	\$3,996
GV12.00-FXF-NRS	12"	1	350	\$5,500
GV14.00-FXF-NRS	14"	1	480	\$8,500
GV16.00-FXF-NRS	16"	1	616	\$11,700

GV-MECHANICAL JOINT SERIES

GATE VALVES, CAST IRON C515 CLASS 150

FLANGED BY FLANGED, NRS RESILIENT WEDGE, EPOXY COATED

Model Number	Size	Qty. per Carton	Weight per Carton (Lbs.)	List Price (Each)
GV2.00-MJ-NRS	2"	1	32	\$561
GV2.50-MJ-NRS	2 1/2"	1	37	\$618
GV3.00-MJ-NRS	3"	1	44	\$798
GV4.00-MJ-NRS	4"	1	53	\$1,054
GV6.00-MJ-NRS	6"	1	94	\$1,683
GV8.00-MJ-NRS	8"	1	150	\$2,842
GV10.00-MJ-NRS	10"	1	247	\$4,378
GV12.00-MJ-NRS	12"	1	330	\$5,574
GV14.00-MJ-NRS	14"	1	480	\$14,094
GV16.00-MJ-NRS	16"	1	610	\$17,450

GROOVED BY GROOVED, NRS RESILIENT WEDGE, EPOXY COATED

Model Number	Size	Qty. per Carton	Weight per Carton (Lbs.)	List Price (Each)
GV2.00-GXG-NRS	2"	1	25	\$510
GV2.50-GXG-NRS	2 1/2"	1	35	\$594
GV3.00-GXG-NRS	3"	1	45	\$648
GV4.00-GXG-NRS	4"	1	80	\$864
GV6.00-GXG-NRS	6"	1	120	\$1,376
GV8.00-GXG-NRS	8"	1	200	\$2,347
GV10.00-GXG-NRS	10"	1	355	\$3,616

SWING CHECK VALVES

SWING CHECK VALVE (ANSI 125)

Model Number	Size	Qty. per Carton	Weight per Carton (Lbs.)	List Price (Each)
CV2.00-FLG-RD	2"	1	25	\$477
CV2.50-FLG-RD	2 1/2"	1	29	\$547
CV3.00-FLG-RD	3"	1	37	\$655
CV4.00-FLG-RD	4"	1	55	\$919
CV6.00-FLG-RD	6"	1	110	\$1,572
CV8.00-FLG-RD	8"	1	128	\$2,721
CV10.00-FLG-RD	10"	1	480	\$4,435
CV12.00-FLG-RD	12"	1	620	\$6,336
CV14.00-FLG-RD	14"	1	1100	\$13,416
CV16.00-FLG-RD	16"	1	1496	\$20,449



GV2.50-MJ-NRS (ILLUSTRATED)

FOR SPEC. SHEETS GO TO www.beecobackflow.com

The BEECO® Series GV-FXF-NRS-MJ is an AWWA C515 Mechanical Joint x Mechanical Joint resilient seated gate valve with a non-rising stem. MJ bells are to AWWA C153 Standard. The body, bonnet, and wedge (disc) are of high strength ductile-iron, ASTM A536, Grade 65-45-12. The wedge is encapsulated with EPDM rubber. The stem and bolts are of stainless steel.

Function: Used in irrigation and water distribution. The BEECO Series GV-FXF-NRS-MJ is best used in the fully opened or fully closed position, but can be used as a throttling valve.

Features:

- 2" Square Operating Nut.
- 300 P.S.I. (20.8 bar) water working pressure rating.
- Fusion Bonded Interior and Exterior to AWWA C550 Standard.

"MIFAB wants to be a leader. To achieve this they continue to innovate and find new products."

- Tom Babcock of Kast Marketing, Chicago, IL



CV4.00-FLG-RD (ILLUSTRATED)

FOR SPEC. SHEETS GO TO www.beecobackflow.com

BEECO CV Series Swing Check Valves are full port valves that provide maximum flow with very low headloss. Top entry access for inspection and cleaning.

WORKING PRESSURE: 200 psi

BODY & COVER: Epoxy Coated Cast Iron

FLANGES: ANSI 125 B16.1

DISC TRIM: EPDM

TEMPERATURE: 15 F to 180 F



CV4.00-FLG-RD-WS (ILLUSTRATED)
FOR SPEC. SHEETS GO TO
www.beecobackflow.com

BEECO CV Series Lever & Weight Check Valves are full port valves that provide maximum flow with very low headloss. The Lever & Weight allow for adjustable valve speed. Top entry access for inspection and cleaning. Complies with AWWA C508.

WORKING PRESSURE: 200 psi

BODY & COVER: Epoxy Coated Cast Iron

FLANGES: ANSI 125 B16.1

DISC TRIM: EPDM

TEMPERATURE: 15°F to 250°F

SWING CHECK VALVE WITH LEVER & WEIGHT (ANSI 125)				
Model Number	Size	Qty. per Carton	Weight per Carton (Lbs.)	List Price (Each)
CV2.00-FLG-RD-WS	2"	1	37	\$622
CV2.50-FLG-RD-WS	2 1/2"	1	50	\$697
CV3.00-FLG-RD-WS	3"	1	58	\$815
CV4.00-FLG-RD-WS	4"	1	92	\$1,100
CV6.00-FLG-RD-WS	6"	1	170	\$1,886
CV8.00-FLG-RD-WS	8"	1	286	\$3,269
CV10.00-FLG-RD-WS	10"	1	452	\$5,323
CV12.00-FLG-RD-WS	12"	1	659	\$7,603
CV14.00-FLG-RD-WS	14"	1	1155	\$16,099
CV16.00-FLG-RD-WS	16"	1	1562	\$24,546



SCV4.00-FLG-SS (ILLUSTRATED)
FOR SPEC. SHEETS GO TO
www.beecobackflow.com

BEECO SCV Series Flanged Silent Check Valves are spring loaded double guided check valves which close quickly preventing reverse flow and reduce water hammer.

WORKING PRESSURE: 200 psi

BODY: Epoxy Coated Cast Iron

FLANGES: ANSI 125 B16.1

DISC & SEAT: 304 Stainless Steel

DISC TRIM: EPDM

TEMPERATURE: 15°F to 250°F

SILENT CHECK VALVES

FLANGED SILENT CHECK VALVE (ANSI 125)				
Model Number	Size	Qty. per Carton	Weight per Carton (Lbs.)	List Price (Each)
SCV2.00-FLG-SS	2"	1	17	\$521
SCV2.50-FLG-SS	2 1/2"	1	23	\$679
SCV3.00-FLG-SS	3"	1	30	\$862
SCV4.00-FLG-SS	4"	1	40	\$1,218
SCV6.00-FLG-SS	6"	1	75	\$2,143
SCV8.00-FLG-SS	8"	1	133	\$3,625
SCV10.00-FLG-SS	10"	1	176	\$6,026
SCV12.00-FLG-SS	12"	1	275	\$9,318
SCV14.00-FLG-SS	14"	1	407	\$16,258
SCV16.00-FLG-SS	16"	1	565	\$18,454

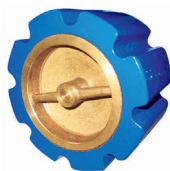

WSCV10.00 (ILLUSTRATED)
FOR SPEC. SHEETS GO TO
www.beecobackflow.com

BEECO WSCV Series Wafer Silent Check Valves are spring loaded double guided check valves which close quickly preventing reverse flow and reduce water hammer.

WORKING PRESSURE: 200 psi

BODY: Epoxy Coated Cast Iron

BOLT PATTERN: ANSI 125 B16.1

DISC & SEAT: 304 Stainless Steel

DISC TRIM: EPDM

TEMPERATURE: 15°F to 250°F

WAFER SILENT CHECK VALVE				
Model Number	Size	Qty. per Carton	Weight per Carton (Lbs.)	List Price (Each)
WSCV2.00	2"	1	6	\$346
WSCV2.50	2 1/2"	1	9	\$415
WSCV3.00	3"	1	13	\$545
WSCV4.00	4"	1	20	\$749
WSCV6.00	6"	1	48	\$1,458
WSCV8.00	8"	1	72	\$2,537
WSCV10.00	10"	1	123	\$4,556
WSCV12.00	12"	1	216	\$7,069

FLEX CHECK VALVES

FLEX CHECK VALVE (ANSI 150)				
Model Number	Size	Qty. per Carton	Weight per Carton (Lbs.)	List Price (Each)
FCV2.00	2"	1	29	\$643
FCV2.50	2 1/2"	1	32	\$784
FCV3.00	3"	1	51	\$967
FCV4.00	4"	1	70	\$1,370
FCV6.00	6"	1	128	\$2,442
FCV8.00	8"	1	264	\$4,786
FCV10.00	10"	1	396	\$6,852
FCV12.00	12"	1	528	\$9,136
FCV14.00	14"	1	660	\$11,995
FCV16.00	16"	1	792	\$16,352



FCV6.00 (ILLUSTRATED)
FOR SPEC. SHEETS GO TO
www.beecobackflow.com

BEECO Series FCV Flex Check Valve are designed to close quickly to reduce water hammer. The disc an approximate 35 degree travel from the full open to closed position. The valve has top entry access for ease of cleaning and inspection, and has a bottom plug for the addition of a back-flushing attachment.

"We have used the Mifab products for many years, especially the MR500 trap primer units. We have found them to be very reliable and competitively priced. We will continue to use them in the future."

- Marc Griffin @ Texas PS

BALL CHECK VALVES

BALL CHECK VALVE (THREADED)				
Model Number	Size	Qty. per Carton	Weight per Carton (Lbs.)	List Price (Each)
BCV1.00-IPS	1"	1	8	\$124
BCV1.25-IPS	1 1/4"	1	10	\$132
BCV1.50-IPS	1 1/2"	1	12	\$180
BCV2.00-IPS	2"	1	15	\$235
BCV2.50-IPS	2 1/2"	1	19	\$336
BCV3.00-IPS	3"	1	24	\$496



BCV2.00-IPS (ILLUSTRATED)
FOR SPEC. SHEETS GO TO
www.beecobackflow.com

BEECO BCV Series Ball Check Valves are full port valves that provide maximum flow with very low headloss. Fully EPDM coated aluminum ball is self centering allowing positive closure at very low pressures. Top entry access for inspection and cleaning.

BALL CHECK VALVE (ANSI 125)				
Model Number	Size	Qty. per Carton	Weight per Carton (Lbs.)	List Price (Each)
BCV2.00	2"	1	20	\$380
BCV2.50	2 1/2"	1	24	\$481
BCV3.00	3"	1	29	\$574
BCV4.00	4"	1	44	\$784
BCV6.00	6"	1	92	\$1,606
BCV8.00	8"	1	163	\$2,927
BCV10.00	10"	1	304	\$5,353
BCV12.00	12"	1	440	\$9,136



BCV4.00 (ILLUSTRATED)
FOR SPEC. SHEETS GO TO
www.beecobackflow.com

EPV12.00-FLG (ILLUSTRATED)

 FOR SPEC. SHEETS GO TO
www.beecobackflow.com

BEECO EPV Eccentric Plug Valves are used as isolation valves in wastewater systems. They feature a round port Ductile Iron EPDM coated plug and a 90% Nickel fully welded seat overlay for long seal life. 316 Stainless Steel Bearing is oil impregnated, permanently lubricated.

WORKING PRESSURE: 250 psi

BODY & BONNET: Epoxy Coated Ductile Iron ASTM B536

FLANGES: ANSI 150 B16.5

SHAFT SEAL: EPDM V-Packing

TEMPERATURE: 15°F to 250°F

4" and smaller with Lever Handle

6" and larger with Gear Actuator

"We receive very little negative feedback coming in for MIFAB."

- Dan Thomas, Ben Thomas and Associates,
Shade Gap, PA

DU.75-IPS-X-IPS (ILLUSTRATED)

 FOR SPEC. SHEETS GO TO
www.beecobackflow.com

Note: Dielectric Unions that are IPS by IPS are not designated as -LL (no Lead) because they do not have any copper or brass component's.

ECCENTRIC PLUG VALVE
ECCENTRIC PLUG VALVE (ANSI 150)

Model Number	Size	Qty. per Carton	Weight per Carton (Lbs.)	List Price (Each)
EPV2.00-FLG	2"	1	26	\$784
EPV2.50-FLG	2 1/2"	1	30	\$1,328
EPV3.00-FLG	3"	1	40	\$1,500
EPV4.00-FLG	4"	1	70	\$2,027
EPV6.00-FLG	6"	1	136	\$3,947
EPV8.00-FLG	8"	1	190	\$5,798
EPV10.00-FLG	10"	1	344	\$8,323
EPV12.00-FLG	12"	1	439	\$11,279

ECCENTRIC PLUG VALVE (MECHANICAL JOINT)

Model Number	Size	Qty. per Carton	Weight per Carton (Lbs.)	List Price (Each)
EPV3.00-MJ	3"	1	50	\$1,522
EPV4.00-MJ	4"	1	80	\$2,096
EPV6.00-MJ	6"	1	125	\$4,087
EPV8.00-MJ	8"	1	200	\$5,939
EPV10.00-MJ	10"	1	359	\$8,468
EPV12.00-MJ	12"	1	479	\$11,626

DU SERIES
DIELECTRIC UNIONS NO LEAD
DIELECTRIC UNIONS, GALVANIZED, FEMALE IRON PIPE BY COPPER SOLDER JOINT

Model Number	Size	Qty. per Carton	Weight per Carton (Lbs.)	List Price (Each)
DU.50-IPS-X-SWT-LL	1/2"	10	5	\$7
DU.75-IPS-X-SWT-LL	3/4"	10	7	\$10
DU1.00-IPS-X-SWT-LL	1"	5	5	\$14
DU1.25-IPS-X-SWT-LL	1 1/4"	5	13	\$24
DU1.50-IPS-X-SWT-LL	1 1/2"	5	14	\$30
DU2.00-IPS-X-SWT-LL	2"	2	8	\$62

DIELECTRIC UNIONS, GALVANIZED, FEMALE IRON PIPE BY FEMALE IRON PIPE

Model Number	Size	Qty. per Carton	Weight per Carton (Lbs.)	List Price (Each)
DU.50-IPS-X-IPS	1/2"	10	5	\$8
DU.75-IPS-X-IPS	3/4"	10	7	\$12
DU1.00-IPS-X-IPS	1"	5	5	\$15
DU1.25-IPS-X-IPS	1 1/4"	5	12	\$25
DU1.50-IPS-X-IPS	1 1/2"	5	15	\$28
DU2.00-IPS-X-IPS	2"	2	8	\$53

CROSS REFERENCE

AUTOMATIC CONTROL VALVES (ACV)

BEECO **CLA-VAL**

Ref. means the product can be supplied call your rep for price and delivery.

HF-RF.....Ref.....	40-01, Rate Of Flow Control Valve
HF-PS.....Pg. 4.....	50-01, Pressure Relief Control Valve
HF-PS-CV.....Ref.....	50-01D, Pressure Sustaining And Check Valve
HF-RE.....Ref.....	52-03, Surge Anticipator Control Valve
HF-PS-EL.....Ref.....	58-01, Pressure Sustaining And Solenoid Shutoff
HF-BC-DC.....Ref.....	60-11, Dual Chamber Booster Pump Control Valve
HF-BC.....Ref.....	60-31, Single Chamber Booster Pump Control Valve
HF-DW.....Ref.....	61-02, Deep Well Pump Control Valve
HF-CV.....Ref.....	81-02, Check Valve
HF-PR.....Pg. 4.....	90-01, Pressure Reducing Control Valve
HF-PR-CV.....Ref.....	90-01D, Pressure Reducing And Check Valve
HF-PR-PS.....Ref.....	92-01, Pressure Reducing And Sustaining Control
HF-PR-EL.....Ref.....	93-01, Pressure Reducing And Solenoid Shutoff
HF-FLDI.....Pg. 5.....	124-01, On - Off Float Valve (6" And Smaller)
HF-FLDI.....Pg. 5.....	124-02, On - Off Float Valve (8" And Larger)
HF-FL.....Ref.....	129-01, Modulating Float Valve
HF-EL.....Ref.....	136-01A, Solenoid Control Valve (3" And Smaller)
HF-EL.....Pg. 5.....	136-03, ABC Solenoid Control (W/ High Capacity Controls)
HF-AL.....Ref.....	210-01, One Way Flow Altitude Valve
HF-AL-BD.....Ref.....	210-06, Two Way Flow Altitude Valve
HF-AL.....Ref.....	210-03, One Way Flow Altitude Control (Delayed Opening)

BEECO **WATTS**

Ref. means the product can be supplied call your rep for price and delivery.

HF-RF.....Ref.....	114, Rate Of Flow Control Valve
HF-PS.....Pg. 4.....	116, Pressure Relief Control Valve
HF-PS-CV.....Ref.....	116-5, Pressure Sustaining And Check Valve
HF-RE.....Ref.....	116-52, Surge Anticipator Control Valve
HF-PS-EL.....Ref.....	116-31, Pressure Sustaining And Solenoid Shutoff
HF-BC-DC.....Ref.....	513-5, Dual Chamber Booster Pump Control Valve
HF-BC.....Ref.....	413-21, Single Chamber Booster Pump Control Valve
HF-DW.....Ref.....	513-6, Deep Well Pump Control Valve
HF-CV.....Ref.....	118-3, Check Valve
HF-PR.....Ref.....	115, Pressure Reducing Control Valve
HF-PR-CV.....Ref.....	115-3, Pressure Reducing And Check Valve
HF-PR-PS.....Ref.....	115-2, Pressure Reducing And Sustaining Control
HF-PR-EL.....Ref.....	115-4, Pressure Reducing And Solenoid Shutoff
HF-FLDI.....Pg. 5.....	110-14, On - Off Float Valve (6" And Smaller)
HF-FLDI.....Pg. 5.....	110-14, On - Off Float Valve (8" And Larger)
HF-FL.....Pg. 5.....	110-10, Modulating Float Valve
HF-EL.....Pg. 5.....	113-12, Solenoid Control Valve (3" And Smaller)
HF-EL.....Ref.....	113-6, Solenoid Control (W/ High Capacity Controls)
HF-AL.....Ref.....	127-1, One Way Flow Altitude Valve
HF-AL-BD.....Ref.....	127-2, Two Way Flow Altitude Valve
HF-AL.....Ref.....	127-11, One Way Flow Altitude Control (Delayed Opening)

BEECO **BERMAD**

Ref. means the product can be supplied call your rep for price and delivery.

HF-RF.....Ref.....	770, Rate Of Flow Control Valve
--------------------	---------------------------------

HF-PS.....Pg. 4.....	730, Pressure Relief Control Valve
HF-PS-CV.....Ref.....	730-20, Pressure Sustaining And Check Valve
HF-RE.....Ref.....	735-M, Surge Anticipator Control Valve
HF-PS-EL.....Ref.....	730-55, Pressure Sustaining And Solenoid Shutoff
HF-BC-DC.....Ref.....	740Q, Dual Chamber Booster Pump Control Valve
HF-BC.....Ref.....	NA, Single Chamber Booster Pump Control Valve
HF-DW.....Ref.....	745, Deep Well Pump Control Valve
HF-CV.....Ref.....	760-03-V, Check Valve
HF-PR.....Pg. 4.....	720, Pressure Reducing Control Valve
HF-PR-CV.....Ref.....	720-20, Pressure Reducing And Check Valve
HF-PR-PS.....Ref.....	723, Pressure Reducing And Sustaining Control
HF-PR-EL.....Ref.....	720-55, Pressure Reducing And Solenoid Shutoff
HF-FLDI.....Pg. 5.....	750-66-B, On - Off Float Valve (6" And Smaller)
HF-FLDI.....Pg. 5.....	750-66-B, On - Off Float Valve (8" And Larger)
HF-FL.....Ref.....	750-67, Modulating Float Valve
HF-EL.....Pg. 5.....	710, Solenoid Control Valve (3" And Smaller)
HF-EL.....Pg. 5.....	710, Solenoid Control (W/ High Capacity Controls)
HF-AL.....Ref.....	750, One Way Flow Altitude Valve
HF-AL-BD.....Ref.....	750-80, Two Way Flow Altitude Valve
HF-AL.....Ref.....	750-86, One Way Flow Altitude Control (Delayed Opening)

AIR AND VACUUM VALVES

BEECO # **A.R.I. #**

AV2.00-MH-K..... Pg. 17.....	K060, 2" Air & Vacuum Valve (ANSI 150)
AV2.00-MH-K-HP..... Pg. 20.....	K060 2" Air & Vacuum Valve (ANSI 300)
AV3.00-MH-K..... Pg. 17.....	K060 3" Air & Vacuum Valve (ANSI 150)
AV3.00-MH-K-HP..... Pg. 20.....	K060 3" Air & Vacuum Valve (ANSI 300)
AV4.00-MH-K..... Pg. 17.....	K060 4" Air & Vacuum Valve (ANSI 150)
AV4.00-MH-K-HP..... Pg. 20.....	K060 4" Air & Vacuum Valve (ANSI 300)
AV6.00-MH-K..... Pg. 17.....	K060 6" Air & Vacuum Valve (ANSI 150)
AV6.00-MH-K-HP..... Pg. 20.....	K060 6" Air & Vacuum Valve (ANSI 300)
AV8.00-MH-K..... Pg. 17.....	K060 8" Air & Vacuum Valve (ANSI 150)
AV8.00-MH-K-HP..... Pg. 20.....	K060 8" Air & Vacuum Valve (ANSI 300)
AV10.00-MH-K..... Pg. 17.....	K060 10" Air & Vacuum Valve (ANSI 150)
AV10.00-MH-K-HP..... Pg. 20.....	K060 10" Air & Vacuum Valve (ANSI 300)
AV12.00-MS-K..... Pg. 17.....	K060 12" Air & Vacuum Valve (ANSI 150)
AV12.00-MS-K-HP..... Pg. 20.....	K060 12" Air & Vacuum Valve (ANSI 300)

BEECO # **CRISPIN #**

AV.50-P-K..... Pg. 22.....	A5 1/2" Air & Vacuum Valve (NPT)
AV.75-P-K..... Pg. 22.....	AL10 3/4" Air & Vacuum Valve (NPT)
AV2.00-P-K..... Pg. 22.....	AL20 2" Air & Vacuum Valve (NPT)
AV2.00-MH-K..... Pg. 17.....	AL21 2" Air & Vacuum Valve (ANSI 150)
AV2.00-MH-K-HP..... Pg. 20.....	AL22 2" Air & Vacuum Valve (ANSI 300)
AV3.00-MH-K..... Pg. 17.....	AL31 3" Air & Vacuum Valve (ANSI 150)
AV3.00-MH-K-HP..... Pg. 20.....	AL32 3" Air & Vacuum Valve (ANSI 300)
AV4.00-MH-K..... Pg. 17.....	AL41 4" Air & Vacuum Valve (ANSI 150)
AV4.00-MH-K-HP..... Pg. 20.....	AL42 4" Air & Vacuum Valve (ANSI 300)
AV6.00-MH-K..... Pg. 17.....	AL61 6" Air & Vacuum Valve (ANSI 150)
AV6.00-MH-K-HP..... Pg. 20.....	AL62 6" Air & Vacuum Valve (ANSI 300)
AV8.00-MH-K..... Pg. 17.....	AL81 8" Air & Vacuum Valve (ANSI 150)
AV8.00-MH-K-HP..... Pg. 20.....	AL82 8" Air & Vacuum Valve (ANSI 300)
AV10.00-MH-K..... Pg. 17.....	AL101 10" Air & Vacuum Valve (ANSI 150)
AV10.00-MH-K-HP..... Pg. 20.....	AL102 10" Air & Vacuum Valve (ANSI 300)

AV12.00-MS-K..... Pg. 17.....	AL121 12" Air & Vacuum Valve (ANSI 150)
AV12.00-MS-K-HP..... Pg. 20.....	AL122 12" Air & Vacuum Valve (ANSI 300)

BEECO # **APCO #**

AV.50-P-K..... Pg. 22.....	141, 141.2 1/2" Air & Vacuum Valve (NPT)
AV.75-P-K..... Pg. 22.....	142, 142.2 3/4" Air & Vacuum Valve (NPT)
AV2.00-P-K..... Pg. 22.....	144, 144.2 2" Air & Vacuum Valve (NPT)
AV2.00-MH-K..... Pg. 17.....	144, 144.3 2" Air & Vacuum Valve (ANSI 150)
AV2.00-MH-K-HP..... Pg. 20.....	N/A 2" Air & Vacuum Valve (ANSI 300)
AV3.00-MH-K..... Pg. 17.....	146, 146.3 3" Air & Vacuum Valve (ANSI 150)
AV3.00-MH-K-HP..... Pg. 20.....	146, 146.4 3" Air & Vacuum Valve (ANSI 300)
AV4.00-MH-K..... Pg. 17.....	152, 152.1 4" Air & Vacuum Valve (ANSI 150)
AV4.00-MH-K-HP..... Pg. 20.....	152, 152.2 4" Air & Vacuum Valve (ANSI 300)
AV6.00-MH-K..... Pg. 17.....	153, 153.1 6" Air & Vacuum Valve (ANSI 150)
AV6.00-MH-K-HP..... Pg. 20.....	153, 153.2 6" Air & Vacuum Valve (ANSI 300)
AV8.00-MH-K..... Pg. 17.....	154, 154.1 8" Air & Vacuum Valve (ANSI 150)
AV8.00-MH-K-HP..... Pg. 20.....	154, 154.2 8" Air & Vacuum Valve (ANSI 300)
AV10.00-MH-K..... Pg. 17.....	155, 155.1 10" Air & Vacuum Valve (ANSI 150)
AV10.00-MH-K-HP..... Pg. 20.....	155, 155.2 10" Air & Vacuum Valve (ANSI 300)
AV12.00-MS-K..... Pg. 17.....	156, 156.1 12" Air & Vacuum Valve (ANSI 150)
AV12.00-MS-K-HP..... Pg. 20.....	156, 156.2 12" Air & Vacuum Valve (ANSI 300)

BEECO # **VAL-MATIC #**

AV.50-P-K..... Pg. 22.....	100, 150, 1/2" Air & Vacuum Valve (NPT)
AV.75-P-K..... Pg. 22.....	101, 151, 3/4" Air & Vacuum Valve (NPT)
AV2.00-P-K..... Pg. 22.....	102, 152, 2" Air & Vacuum Valve (NPT)
AV2.00-MH-K..... Pg. 17.....	N/A, 2" Air & Vacuum Valve (ANSI 150)
AV2.00-MH-K-HP..... Pg. 20.....	N/A, 2" Air & Vacuum Valve (ANSI 300)
AV3.00-MH-K..... Pg. 17.....	N/A, 3" Air & Vacuum Valve (ANSI 150)
AV3.00-MH-K-HP..... Pg. 20.....	N/A, 3" Air & Vacuum Valve (ANSI 300)
AV4.00-MH-K..... Pg. 17.....	104, 4" Air & Vacuum Valve (ANSI 150)
AV4.00-MH-K-HP..... Pg. 20.....	154, 4" Air & Vacuum Valve (ANSI 300)
AV6.00-MH-K..... Pg. 17.....	106, 6" Air & Vacuum Valve (ANSI 150)
AV6.00-MH-K-HP..... Pg. 20.....	156, 6" Air & Vacuum Valve (ANSI 300)
AV8.00-MH-K..... Pg. 17.....	108, 8" Air & Vacuum Valve (ANSI 150)
AV8.00-MH-K-HP..... Pg. 20.....	158, 8" Air & Vacuum Valve (ANSI 300)
AV10.00-MH-K..... Pg. 17.....	110, 10" Air & Vacuum Valve (ANSI 150)
AV10.00-MH-K-HP..... Pg. 20.....	160, 10" Air & Vacuum Valve (ANSI 300)
AV12.00-MS-K..... Pg. 17.....	112, 12" Air & Vacuum Valve (ANSI 150)
AV12.00-MS-K-HP..... Pg. 20.....	162, 12" Air & Vacuum Valve (ANSI 300)

BEECO # **GA #**

AV.50-P-K..... Pg. 22.....	930, 1/2" Air & Vacuum Valve (NPT)
AV.75-P-K..... Pg. 22.....	930, 3/4" Air & Vacuum Valve (NPT)
AV2.00-P-K..... Pg. 22.....	930, 2" Air & Vacuum Valve (NPT)
AV2.00-MH-K..... Pg. 17.....	930, 2" Air & Vacuum Valve (ANSI 150)
AV2.00-MH-K-HP..... Pg. 20.....	930, 2" Air & Vacuum Valve (ANSI 300)
AV3.00-MH-K..... Pg. 17.....	930, 3" Air & Vacuum Valve (ANSI 150)
AV3.00-MH-K-HP..... Pg. 20.....	930, 3" Air & Vacuum Valve (ANSI 300)
AV4.00-MH-K..... Pg. 17.....	930, 4" Air & Vacuum Valve (ANSI 150)
AV4.00-MH-K-HP..... Pg. 20.....	930, 4" Air & Vacuum Valve (ANSI 300)
AV6.00-MH-K..... Pg. 17.....	930, 6" Air & Vacuum Valve (ANSI 150)
AV6.00-MH-K-HP..... Pg. 20.....	930, 6" Air & Vacuum Valve (ANSI 300)
AV8.00-MH-K..... Pg. 17.....	930, 8" Air & Vacuum Valve (ANSI 150)
AV8.00-MH-K-HP..... Pg. 20.....	930, 8" Air & Vacuum Valve (ANSI 300)
AV10.00-MH-K..... Pg. 17.....	930, 10" Air & Vacuum Valve (ANSI 150)



Distributed by: MIFAB®

AV10.00-MH-K-HP...Pg. 20 930, 10" Air & Vacuum Valve (ANSI 300)
 AV12.00-MS-K.....Pg. 17 930, 12" Air & Vacuum Valve (ANSI 150)
 AV12.00-MS-K-HP..Pg. 20 930, 12" Air & Vacuum Valve (ANSI 300)

BEECO # CLA-VAL #

AV.50-P-K.....Pg. 22 350-AV, 1/2" Air & Vacuum Valve (NPT)
 AV.75-P-K.....Pg. 22 351-AV, 3/4" Air & Vacuum Valve (NPT)
 AV2.00-P-K.....Pg. 22 352-AV, 2" Air & Vacuum Valve (NPT)
 AV2.00-MH-K.....Pg. 17 N/A, 2" Air & Vacuum Valve (ANSI 150)
 AV2.00-MH-K-HP...Pg. 20 N/A, 2" Air & Vacuum Valve (ANSI 300)
 AV3.00-MH-K.....Pg. 17 N/A, 3" Air & Vacuum Valve (ANSI 150)
 AV3.00-MH-K-HP...Pg. 20 N/A, 3" Air & Vacuum Valve (ANSI 300)
 AV4.00-MH-K.....Pg. 17 354-AV, 4" Air & Vacuum Valve (ANSI 150)
 AV4.00-MH-K-HP...Pg. 20 354-AV.3, 4" Air & Vacuum Valve (ANSI 300)
 AV6.00-MH-K.....Pg. 17 356-AV, 6" Air & Vacuum Valve (ANSI 150)
 AV6.00-MH-K-HP...Pg. 20 356-AV.3, 6" Air & Vacuum Valve (ANSI 300)
 AV8.00-MH-K.....Pg. 17 358-AV, 8" Air & Vacuum Valve (ANSI 150)
 AV8.00-MH-K-HP...Pg. 20 358-AV.3, 8" Air & Vacuum Valve (ANSI 300)
 AV10.00-MH-K.....Pg. 17 3510-AV, 10" Air & Vacuum Valve (ANSI 150)
 AV10.00-MH-K-HP..Pg. 20 3510-AV.3, 10" Air & Vacuum Valve (ANSI 300)
 AV12.00-MS-K.....Pg. 17 3512-AV, 12" Air & Vacuum Valve (ANSI 150)
 AV12.00-MS-K-HP..Pg. 20 3512-AV.3, 12" Air & Vacuum Valve (ANSI 300)

COMBINATION AIR VALVES

BEECO # A.R.I. #

AV.50-P-KA.....Pg. 22 D040, 1/2" Combination Air Valve (NPT)
 AV1.00-P-KA.....Pg. 20 D040, 1" Combination Air Valve (NPT) P
 AV2.00-P-KA.....Pg. 22 D040, 2" Combination Air Valve (NPT)
 AV2.00-MH-KA.....Pg. 17 D060, 2" Combination Air Valve (ANSI 150)
 AV2.00-MH-KA-HP..Pg. 20 D060, 2" Combination Air Valve (ANSI 300)
 AV3.00-MH-KA.....Pg. 17 D060, 3" Combination Air Valve (ANSI 150)
 AV3.00-MH-KA-HP..Pg. 20 D060, 3" Combination Air Valve (ANSI 300)
 AV4.00-MH-KA.....Pg. 17 D060, 4" Combination Air Valve (ANSI 150)
 AV4.00-MH-KA-HP..Pg. 20 D060, 4" Combination Air Valve (ANSI 300)
 AV6.00-MH-KA.....Pg. 17 D060, 6" Combination Air Valve (ANSI 150)
 AV6.00-MH-KA-HP..Pg. 20 D060, 6" Combination Air Valve (ANSI 300)
 AV8.00-MH-KA.....Pg. 17 D060, 8" Combination Air Valve (ANSI 150)
 AV8.00-MH-KA-HP..Pg. 20 D060, 8" Combination Air Valve (ANSI 300)
 AV10.00-MH-KA.....Pg. 17 D060, 10" Combination Air Valve (ANSI 150)
 AV10.00-MH-KA-HP..Pg. 20 D060, 10" Combination Air Valve (ANSI 300)
 AV12.00-MS-KA.....Pg. 17 D060, 12" Combination Air Valve (ANSI 150)
 AV3.00-MS-KA-HP..Pg. 19 D060, 12" Combination Air Valve (ANSI 300)
 AV12.00-MS-K-HP..Pg. 19 K060, 12" Air & Vacuum Valve (ANSI 300)

BEECO # CRISPIN #

AV.50-P-KA.....Pg. 22 C5, 1/2" Combination Air Valve (NPT)
 AV1.00-P-KA.....Pg. 22 C10, 1" Combination Air Valve (NPT)
 AV2.00-P-KA.....Pg. 22 C20, 2" Combination Air Valve (NPT)
 AV2.00-MH-KA.....Pg. 17 C21, 2" Combination Air Valve (ANSI 150)
 AV2.00-MH-KA-HP..Pg. 20 C22, 2" Combination Air Valve (ANSI 300)
 AV3.00-MH-KA.....Pg. 17 C31, 3" Combination Air Valve (ANSI 150)
 AV3.00-MH-KA-HP..Pg. 20 C32, 3" Combination Air Valve (ANSI 300)
 AV4.00-MH-KA.....Pg. 17 C41, 4" Combination Air Valve (ANSI 150)
 AV4.00-MH-KA-HP..Pg. 20 C42, 4" Combination Air Valve (ANSI 300)
 AV6.00-MH-KA.....Pg. 17 C61, 6" Combination Air Valve (ANSI 150)
 AV6.00-MH-KA-HP..Pg. 20 C62, 6" Combination Air Valve (ANSI 300)
 AV8.00-MH-KA.....Pg. 17 C81, 8" Combination Air Valve (ANSI 150)

AV8.00-MH-KA-HP...Pg. 20 C82, 8" Combination Air Valve (ANSI 300)
 AV10.00-MH-KA.....Pg. 17 C101, 10" Combination Air Valve (ANSI 150)
 AV10.00-MH-KA-HP..Pg. 20 C102, 10" Combination Air Valve (ANSI 300)
 AV12.00-MS-KA.....Pg. 17 C121, 12" Combination Air Valve (ANSI 150)
 AV3.00-MS-KA-HP...Pg. 19 C122, 12" Combination Air Valve (ANSI 300)
 AV12.00-MS-K-HP...Pg. 19 AL122, 12" Air & Vacuum Valve (ANSI 300)

BEECO # APCO #

AV.50-P-KA.....Pg. 22 N/A, 1/2" Combination Air Valve (NPT)
 AV1.00-P-KA.....Pg. 22 N/A, 1" Combination Air Valve (NPT)
 AV2.00-P-KA.....Pg. 22 N/A, 2" Combination Air Valve (NPT)
 AV2.00-MH-KA.....Pg. 17 N/A, 2" Combination Air Valve (ANSI 150)
 AV2.00-MH-KA-HP..Pg. 20 N/A, 2" Combination Air Valve (ANSI 300)
 AV3.00-MH-KA.....Pg. 17 N/A, 3" Combination Air Valve (ANSI 150)
 AV3.00-MH-KA-HP..Pg. 20 N/A, 3" Combination Air Valve (ANSI 300)
 AV4.00-MH-KA.....Pg. 17 N/A, 4" Combination Air Valve (ANSI 150)
 AV4.00-MH-KA-HP..Pg. 20 N/A, 4" Combination Air Valve (ANSI 300)
 AV6.00-MH-KA.....Pg. 17 150C, 150C.1, 6" Combination Air Valve (ANSI 150)
 AV6.00-MH-KA-HP..Pg. 20 150C, 150C.2, 6" Combination Air Valve (ANSI 300)
 AV8.00-MH-KA.....Pg. 17 151C, 150C.1, 8" Combination Air Valve (ANSI 150)
 AV8.00-MH-KA-HP..Pg. 20 151C, 150C.2, 8" Combination Air Valve (ANSI 300)
 AV10.00-MH-KA.....Pg. 17 N/A, 10" Combination Air Valve (ANSI 150)
 AV10.00-MH-KA-HP..Pg. 20 N/A, 10" Combination Air Valve (ANSI 300)
 AV12.00-MS-KA.....Pg. 17 N/A, 12" Combination Air Valve (ANSI 150)
 AV3.00-MS-KA-HP...Pg. 19 N/A, 12" Combination Air Valve (ANSI 300)
 AV12.00-MS-K-HP..Pg. 19 156, 156.2, 12" Air & Vacuum Valve (ANSI 300)

BEECO # VAL-MATIC #

AV.50-P-KA.....Pg. 22 N/A, 1/2" Combination Air Valve (NPT)
 AV1.00-P-KA.....Pg. 22 N/A, 1" Combination Air Valve (NPT)
 AV2.00-P-KA.....Pg. 22 N/A, 2" Combination Air Valve (NPT)
 AV2.00-MH-KA.....Pg. 17 N/A, 2" Combination Air Valve (ANSI 150)
 AV2.00-MH-KA-HP..Pg. 20 N/A, 2" Combination Air Valve (ANSI 300)
 AV3.00-MH-KA.....Pg. 17 N/A, 3" Combination Air Valve (ANSI 150)
 AV3.00-MH-KA-HP..Pg. 20 N/A, 3" Combination Air Valve (ANSI 300)
 AV4.00-MH-KA.....Pg. 17 N/A, 4" Combination Air Valve (ANSI 150)
 AV4.00-MH-KA-HP..Pg. 20 N/A, 4" Combination Air Valve (ANSI 300)
 AV6.00-MH-KA.....Pg. 17 206C, 6" Combination Air Valve (ANSI 150)
 AV6.00-MH-KA-HP..Pg. 20 256C, 6" Combination Air Valve (ANSI 300)
 AV8.00-MH-KA.....Pg. 17 208C, 8" Combination Air Valve (ANSI 150)
 AV8.00-MH-KA-HP..Pg. 20 258C, 8" Combination Air Valve (ANSI 300)
 AV10.00-MH-KA.....Pg. 17 N/A, 10" Combination Air Valve (ANSI 150)
 AV10.00-MH-KA-HP..Pg. 20 N/A, 10" Combination Air Valve (ANSI 300)
 AV12.00-MS-KA.....Pg. 17 N/A, 12" Combination Air Valve (ANSI 150)
 AV3.00-MS-KA-HP..Pg. 19 N/A, 12" Combination Air Valve (ANSI 300)
 AV12.00-MS-K-HP..Pg. 19 162, 12" Air & Vacuum Valve (ANSI 300)

BEECO # GA #

AV.50-P-KA.....Pg. 22 Fig. 945, 1/2" Combination Air Valve (NPT)
 AV1.00-P-KA.....Pg. 22 Fig. 945, 1" Combination Air Valve (NPT)
 AV2.00-P-KA.....Pg. 22 Fig. 945, 2" Combination Air Valve (NPT)
 AV2.00-MH-KA.....Pg. 17 N/A, 2" Combination Air Valve (ANSI 150)
 AV2.00-MH-KA-HP..Pg. 20 N/A, 2" Combination Air Valve (ANSI 300)
 AV3.00-MH-KA.....Pg. 17 N/A, 3" Combination Air Valve (ANSI 150)
 AV3.00-MH-KA-HP..Pg. 20 N/A, 3" Combination Air Valve (ANSI 300)
 N/A.....Fig. 945, 4" Combination Air Valve (NPT)

AV4.00-MH-KA.....Pg. 17 Fig. 945, 4" Combination Air Valve (ANSI 150)
 AV4.00-MH-KA-HP..Pg. 20 Fig. 945, 4" Combination Air Valve (ANSI 300)
 AV6.00-MH-KA.....Pg. 17 Fig. 960, 6" Combination Air Valve (ANSI 150)
 AV6.00-MH-KA-HP..Pg. 20 Fig. 960, 6" Combination Air Valve (ANSI 300)
 AV8.00-MH-KA.....Pg. 17 Fig. 960, 8" Combination Air Valve (ANSI 150)
 AV8.00-MH-KA-HP..Pg. 20 Fig. 960, 8" Combination Air Valve (ANSI 300)
 AV10.00-MH-KA.....Pg. 17 N/A, 10" Combination Air Valve (ANSI 150)
 AV10.00-MH-KA-HP..Pg. 20 N/A, 10" Combination Air Valve (ANSI 300)
 AV12.00-MS-KA.....Pg. 17 N/A, 12" Combination Air Valve (ANSI 150)
 AV3.00-MS-KA-HP...Pg. 19 N/A, 12" Combination Air Valve (ANSI 300)
 AV12.00-MS-K-HP...Pg. 19 930, 12" Air & Vacuum Valve (ANSI 300)

UNIVERSAL AIR RELEASE VALVES

BEEECO # A.R.I. #

AV1.00-P-KA.....Pg. 22 D040, 1" Combination Air Valve (NPT)
 AV2.00-P-KA.....Pg. 22 D040, 2" Combination Air Valve (NPT)
 AV2.00-MH-KA.....Pg. 17 D060, 2" Combination Air Valve (ANSI 150)
 AV2.00-MH-KA-HP..Pg. 20 D060, 2" Combination Air Valve (ANSI 300)
 AV3.00-MH-KA.....Pg. 17 D060, 3" Combination Air Valve (ANSI 150)
 AV3.00-MH-KA-HP..Pg. 20 D060, 3" Combination Air Valve (ANSI 300)

BEEECO # CRISPIN #

AV1.00-P-KA.....Pg. 22 UL10, 1" Combination Air Valve (NPT)
 AV2.00-P-KA.....Pg. 22 UL20, 2" Combination Air Valve (NPT)
 AV2.00-MH-KA.....Pg. 17 UL21, 2" Combination Air Valve (ANSI 150)
 AV2.00-MH-KA-HP..Pg. 20 UL22, 2" Combination Air Valve (ANSI 300)
 AV3.00-MH-KA.....Pg. 17 UL31, 3" Combination Air Valve (ANSI 150)
 AV3.00-MH-KA-HP..Pg. 20 UL31, 3" Combination Air Valve (ANSI 300)

BEEECO # APCO #

AV1.00-P-KA.....Pg. 22 143C, 1" Combination Air Valve (NPT)
 AV2.00-P-KA.....Pg. 22 145C, 2" Combination Air Valve (NPT)
 AV2.00-MH-KA.....Pg. 17 N/A, 2" Combination Air Valve (ANSI 150)
 AV2.00-MH-KA-HP..Pg. 20 N/A, 2" Combination Air Valve (ANSI 300)
 AV3.00-MH-KA.....Pg. 17 147C, 3" Combination Air Valve (ANSI 150)
 AV3.00-MH-KA-HP..Pg. 20 147C, 3" Combination Air Valve (ANSI 300)

BEEECO # VAL-MATIC #

AV1.00-P-KA.....Pg. 22 201C.2, 1" Combination Air Valve (NPT)
 AV2.00-P-KA.....Pg. 22 202C.2, 2" Combination Air Valve (NPT)
 AV2.00-MH-KA.....Pg. 17 N/A, 2" Combination Air Valve (ANSI 150)
 AV2.00-MH-KA-HP..Pg. 20 N/A, 2" Combination Air Valve (ANSI 300)
 AV3.00-MH-KA.....Pg. 17 203C.14, 3" Combination Air Valve (ANSI 150)
 AV3.00-MH-KA-HP..Pg. 20 203C.15, 3" Combination Air Valve (ANSI 300)

BEEECO # GA #

AV1.00-P-KA.....Pg. 22 N/A, 1" Combination Air Valve (NPT)
 AV2.00-P-KA.....Pg. 22 N/A, 2" Combination Air Valve (NPT)
 AV2.00-MH-KA.....Pg. 17 N/A, 2" Combination Air Valve (ANSI 150)
 AV2.00-MH-KA-HP..Pg. 20 N/A, 2" Combination Air Valve (ANSI 300)
 AV3.00-MH-KA.....Pg. 17 945J, 3" Combination Air Valve (ANSI 150)
 AV3.00-MH-KA-HP..Pg. 20 N/A, 3" Combination Air Valve (ANSI 300)



Distributed by: **MIFAB**

BEECO #	CLA-VAL #
AV1.00-P-KA	Pg. 22361-CAV564.3, 1" Combination Air Valve (NPT)
AV2.00-P-KA	Pg. 22362-CAV332.3, 2", Combination Air Valve (NPT)
AV2.00-MH-KA	Pg. 17N/A, 2" Combination Air Valve (ANSI 150)
AV2.00-MH-KA-HP	Pg. 20 N/A, 2" Combination Air Valve (ANSI 300)
AV3.00-MH-KA	Pg. 17363-CAV332F, 3", Combination Air Valve (ANSI 150)
AV3.00-MH-KA-HP	Pg. 20363-CAV332.3, 3", Combination Air Valve (ANSI 300)

AIR RELEASE VALVES

BEECO #	A.R.I. #
AV.50-P-A	Pg. 22S050, 1/2" Air Release Valve (NPT)
AV.75-P-A	Pg. 22S050, 3/4" Air Release Valve (NPT)
AV1.00-P-A	Pg. 22S050, 1" Air Release Valve (NPT)
AV.50-P-A	Pg. 22S050, 1/2" Air Release Valve (NPT)
AV.75-P-A	Pg. 22S050, 3/4" Air Release Valve (NPT)
AV1.00-P-A	Pg. 22S050, 1" Air Release Valve (NPT)

BEECO #	CRISPIN #
AV.50-P-A	Pg. 22AR5, 1/2" Air Release Valve (NPT)
AV.75-P-A	Pg. 22AR8, 3/4" Air Release Valve (NPT)
AV1.00-P-A	Pg. 22AR10, 1" Air Release Valve (NPT)
AV.50-P-A	Pg. 22M5, 1/2" Air Release Valve (NPT)
AV.75-P-A	Pg. 22M8, 3/4" Air Release Valve (NPT)
AV1.00-P-A	Pg. 22M10, 1" Air Release Valve (NPT)

BEECO #	APCO #
AV.50-P-A	Pg. 2250, 50.1, 1/2" Air Release Valve (NPT)
AV.75-P-A	Pg. 2250, 50.2, 3/4" Air Release Valve (NPT)
AV1.00-P-A	Pg. 2250, 50.3, 1" Air Release Valve (NPT)
AV.50-P-A	Pg. 22N/A, 1/2" Air Release Valve (NPT)
AV.75-P-A	Pg. 2265, 65.1, 3/4" Air Release Valve (NPT)
AV1.00-P-A	Pg. 22N/A, 1" Air Release Valve (NPT)

BEECO #	VAL-MATIC #
AV.50-P-A	Pg. 2215, 15A, 1/2" Air Release Valve (NPT)
AV.75-P-A	Pg. 2215, 15A.2, 3/4" Air Release Valve (NPT)
AV1.00-P-A	Pg. 2215, 15A.3, 1" Air Release Valve (NPT)
AV.50-P-A	Pg. 2222, 1/2" Air Release Valve (NPT)
AV.75-P-A	Pg. 2222, 25, 3/4" Air Release Valve (NPT)
AV1.00-P-A	Pg. 2222, 25, 1" Air Release Valve (NPT)

BEECO #	GA #
AV.50-P-A	Pg. 22905, 1/2" Air Release Valve (NPT)
AV.75-P-A	Pg. 22905, 3/4" Air Release Valve (NPT)
AV1.00-P-A	Pg. 22910, 912, 1" Air Release Valve (NPT)
AV.50-P-A	Pg. 22910, 912, 1/2" Air Release Valve (NPT)
AV.75-P-A	Pg. 22910, 912, 3/4" Air Release Valve (NPT)
AV1.00-P-A	Pg. 22910, 912, 1" Air Release Valve (NPT)

BEECO #	CLA-VAL #
AV.50-P-A	Pg. 22N/A, 1/2" Air Release Valve (NPT)
AV.75-P-A	Pg. 22N/A, 3/4" Air Release Valve (NPT)
AV1.00-P-A	Pg. 22N/A, 1" Air Release Valve (NPT)
AV.50-P-A	Pg. 2234AR-116, 34AR-332, 1/2" Air Release Valve (NPT)
AV.75-P-A	Pg. 2234AR-116, 34AR-332,34AR-018, 3/4" Air Release Valve (NPT)
AV1.00-P-A	Pg. 2234AR-116, 34AR-332, 34AR-018, 1" Air Release Valve (NPT)

DEEP WELL VALVES

BEECO #	A.R.I. #
AV2.00-MH-KA-SA	Pg. 17N/A, 2" Combination Air Valve with Surge Arresting Feature (ANSI 150)
AV2.00-MH-KA-SA-HP	Pg. 19N/A, 2" Combination Air Valve with Surge Arresting Feature (ANSI 300)
AV3.00-MH-KA-SA	Pg. 17N/A, 3" Combination Air Valve with Surge Arresting Feature (ANSI 150)
AV3.00-MH-KA-SA-HP	Pg. 19N/A, 3" Combination Air Valve with Surge Arresting Feature (ANSI 300)
AV4.00-MH-KA-SA	Pg. 17N/A, 4" Combination Air Valve with Surge Arresting Feature (ANSI 150)
AV4.00-MH-KA-SA-HP	Pg. 19N/A, 4" Combination Air Valve with Surge Arresting Feature (ANSI 300)
AV6.00-MH-KA-SA	Pg. 17N/A, 6" Combination Air Valve with Surge Arresting Feature (ANSI 150)
AV6.00-MH-KA-SA-HP	Pg. 19N/A, 6" Combination Air Valve with Surge Arresting Feature (ANSI 300)

BEECO #	CRISPIN #
AV2.00-MH-KA-SA	DL21, 2" Combination Air Valve with Surge Arresting Feature (ANSI 150)
AV2.00-MH-KA-SA-HP	DL22, 2" Combination Air Valve with Surge Arresting Feature (ANSI 300)
AV3.00-MH-KA-SA	DL31, 3" Combination Air Valve with Surge Arresting Feature (ANSI 150)
AV3.00-MH-KA-SA-HP	DL32, 3" Combination Air Valve with Surge Arresting Feature (ANSI 300)
AV4.00-MH-KA-SA	DL41, 4" Combination Air Valve with Surge Arresting Feature (ANSI 150)
AV4.00-MH-KA-SA-HP	DL42, 4" Combination Air Valve with Surge Arresting Feature (ANSI 300)
AV6.00-MH-KA-SA	DL61, 6" Combination Air Valve with Surge Arresting Feature (ANSI 150)
AV6.00-MH-KA-SA-HP	DL62, 6" Combination Air Valve with Surge Arresting Feature (ANSI 300)

BEECO #	APCO #
AV2.00-MH-KA-SA	Pg. 17144WDT, 144WDT.1, 2" Combination Air Valve with Surge Arresting Feature (ANSI 150)
AV2.00-MH-KA-SA-HP	Pg. 19N/A, 2" Combination Air Valve with Surge Arresting Feature (ANSI 300)
AV3.00-MH-KA-SA	Pg. 17146WDT, 146WDT.1, 3" Combination Air Valve with Surge Arresting Feature (ANSI 150)
AV3.00-MH-KA-SA-HP	Pg. 19N/A, 3" Combination Air Valve with Surge Arresting Feature (ANSI 300)
AV4.00-MH-KA-SA	Pg. 17N/A, 4" Combination Air Valve with Surge Arresting Feature (ANSI 150)
AV4.00-MH-KA-SA-HP	Pg. 19N/A, 4" Combination Air Valve with Surge Arresting Feature (ANSI 300)
AV6.00-MH-KA-SA	Pg. 17N/A, 6" Combination Air Valve with Surge Arresting Feature (ANSI 150)
AV6.00-MH-KA-SA-HP	Pg. 19N/A, 6" Combination Air Valve with Surge Arresting Feature (ANSI 300)

BEECO #	VAL-MATIC #
AV2.00-MH-KA-SA	103WST, 153WST, 2" Combination Air Valve with Surge Arresting Feature (ANSI 300)
AV3.00-MH-KA-SA	Pg. 17N/A, 3" Combination Air Valve with Surge Arresting Feature (ANSI 150)
AV3.00-MH-KA-SA-HP	Pg. 19N/A, 3" Combination Air Valve with Surge Arresting Feature (ANSI 300)
AV4.00-MH-KA-SA	Pg. 17104WST, 104WST.2, 4" Combination Air Valve with Surge Arresting Feature (ANSI 150)
AV4.00-MH-KA-SA-HP	Pg. 19154WST, 154WST.2, 4" Combination Air Valve with Surge Arresting Feature (ANSI 300)
AV6.00-MH-KA-SA	Pg. 17106WST, 106WST.2, 6" Combination Air Valve with Surge Arresting Feature (ANSI 150)

AV6.00-MH-KA-SA-HP	Pg. 19156WST, 156WST.2, 6" Combination Air Valve with Surge Arresting Feature (ANSI 300)
--------------------	---

BEECO #	GA #
AV2.00-MH-KA-SA	Pg. 17Fig. 933, 2" Combination Air Valve with Surge Arresting Feature (ANSI 150)
AV2.00-MH-KA-SA-HP	Pg. 19Fig. 933, 2" Combination Air Valve with Surge Arresting Feature (ANSI 300)
AV3.00-MH-KA-SA	Pg. 17Fig. 933, 3" Combination Air Valve with Surge Arresting Feature (ANSI 150)
AV3.00-MH-KA-SA-HP	Pg. 19Fig. 933, 3" Combination Air Valve with Surge Arresting Feature (ANSI 300)
AV4.00-MH-KA-SA	Pg. 17Fig. 933, 4" Combination Air Valve with Surge Arresting Feature (ANSI 150)
AV4.00-MH-KA-SA-HP	Pg. 19Fig. 933, 4" Combination Air Valve with Surge Arresting Feature (ANSI 300)
AV6.00-MH-KA-SA	Pg. 17N/A, 6" Combination Air Valve with Surge Arresting Feature (ANSI 150)
AV6.00-MH-KA-SA-HP	Pg. 19N/A, 6" Combination Air Valve with Surge Arresting Feature (ANSI 300)

BEECO #	CLA-VAL #
AV2.00-MH-KA-SA	Pg. 17N/A, 2" Combination Air Valve with Surge Arresting Feature (ANSI 150)
AV2.00-MH-KA-SA-HP	Pg. 17N/A, 2" Combination Air Valve with Surge Arresting Feature (ANSI 300)
AV3.00-MH-KA-SA	Pg. 17N/A, 3" Combination Air Valve with Surge Arresting Feature (ANSI 150)
AV3.00-MH-KA-SA-HP	Pg. 19N/A, 3" Combination Air Valve with Surge Arresting Feature (ANSI 300)
AV4.00-MH-KA-SA	Pg. 1774-WS, 4" Combination Air Valve with Surge Arresting Feature (ANSI 150)
AV4.00-MH-KA-SA-HP	Pg. 1974-WS, 4" Combination Air Valve with Surge Arresting Feature (ANSI 300)
AV6.00-MH-KA-SA	Pg. 17376-WS, 6" Combination Air Valve with Surge Arresting Feature (ANSI 150)
AV6.00-MH-KA-SA-HP	Pg. 19376-WS, 6" Combination Air Valve with Surge Arresting Feature (ANSI 300)

BACKFLOW PREVENTERS

VALVE TYPES	BEECO	EBCO
DETECTOR CHECK VALVE		
DOUBLE CHECK	FDC Pg. 27 to 34805YD 21/2" - 10"	
VALVE	FDC Pg. 26850 1/2" - 2"	
ASSEMBLY	FDC Pg. 27 to 34850 21/2" - 10"	
ASSEMBLY	FDC Pg. 27 to 34870V 21/2" - 10"	
ASSEMBLY	FDC Pg. 27 to 34857 21/2" - 3"	
DOUBLE CHECK	DCDA Pg. 30806YD 3" - 10"	
DETECTOR	DCDA Pg. 30856 21/2" - 10"	
ASSEMBLY	DCDA Pg. 30876V 21/2" - 10"	
ASSEMBLY	DCDA Pg. 30858 21/2" - 3"	
REDUCED	RPZ Pg. 39860 1/2" - 2"	
PRESSURE	RPZ Pg. 39825YA 3/4" - 2"	
ZONE	RPZ Pg. 39825Y 3/4" - 2"	
ASSEMBLY	RPZ Pg. 40 to 50825YD 21/2" - 10"	
ASSEMBLY	RPZ Pg. 40 to 50860 21/2" - 10"	
ASSEMBLY	RPZ Pg. 40 to 50880V 21/2" - 10"	
ASSEMBLY	RPZ Pg. 40 to 50867 21/2" - 3"	
REDUCED	RPDA Pg. 44826YD	
PRESSURE	RPDA Pg. 4421/2" - 10"	
ATMOSPHERIC	ASVB Pg. 58710/715 1/2" - 2"	
DUAL CHECK	DC Pg. 51510 1/2", 3/4"	
VALVES	DC Pg. 51	

VALVE TYPES	BEECO	AMES
FDC SS	FDC Pg. 331000SS DCV 4" - 10"	
DOUBLE CHECK	FDC Pg. 262000B 1/2" - 2"	
VALVE	FDC Pg. 27 to 29C-200 21/2" - 10"	
ASSEMBLY	FDC Pg. 27 to 29C-200N 21/2" - 10"	

Design and dimensions are subject to modification. Prices do not include applicable taxes.

Visit www.beecockbackflow.com for the most recent product information.

BEECO, Inc., 1321 West 119th Street, Chicago, Illinois 60643-5109, USA

Toll Free: 1-800-465-2736, Fax: 1-773-341-3049

All sales subject to BEECO's Terms and Warranties. Please refer to page no. 64.

sales@mifab.com • Canada Toll Free: 1-800-387-3880



CROSS REFERENCE

BEECO-2019-07

Distributed by: **MIFAB**

ASSEMBLY.....FDC.....Pg. 33.....2000SS 21/2" - 12"
ASSEMBLY.....FDC.....Pg. 33.....2000SE 21/2"
ASSEMBLY.....FDC.....Pg. 26.....200B 1/2" - 2"
ASSEMBLY.....FDC.....Pg. 27 to 29.....M-200 21/2" - 10"
ASSEMBLY.....FDC.....None.....M-200N 21/2" - 10"
DOUBLE CHECK.....FDC.....Pg. 26.....3000B 2"
DETEC to R.....DCDA.....Pg. 30.....C-300 21/2" - 10"
ASSEMBLY.....DCDA.....Pg. 30.....C-300N 21/2" - 10"
ASSEMBLY.....DCDA.....Pg. 30.....3000SS 21/2" - 12"
ASSEMBLY.....DCDA.....Pg. 30.....3000SE 21/2"
ASSEMBLY.....DCDA.....Pg. 30.....M-300 21/2" - 10"
ASSEMBLY.....DCDA.....Pg. 30.....M-300N 21/2" - 10"
REDUCED.....RPZ.....Pg. 40 to 50.....C-400 21/2" - 10"
PRESSURE.....RPZ.....Pg. 40 to 50.....C-400N 21/2" - 10"
ZONE.....RPZ.....Pg. 40 to 50.....C-400Z 21/2" - 10"
ASSEMBLY.....RPZ.....Pg. 40 to 50.....4000SS 21/2" - 10"
ASSEMBLY.....RPZ.....Pg. 40.....4000B 1/2" - 2"
ASSEMBLY.....RPZ.....Pg. 40 to 50.....M-400 21/2" - 10"
ASSEMBLY.....RPZ.....None.....M-400N 21/2" - 10"
ASSEMBLY.....RPZ.....Pg. 40.....400B 1/2" - 2"
REDUCED.....RPDA.....Pg. 40 to 50.....C-500 21/2" - 10"
PRESSURE.....RPDA.....Pg. 40 to 50.....C-500N 21/2" - 10"
DETEC to R.....RPDA.....Pg. 40 to 50.....C-500Z 21/2" - 10"
ASSEMBLY.....RPDA.....Pg. 47.....5000 SS 21/2" - 10"
ASSEMBLY.....RPDA.....Pg. 47.....5000CIV 21/2" - 10"
ASSEMBLY.....RPDA.....Pg. 47.....M-500 21/2" - 10"
ASSEMBLY.....RPDA.....Pg. 47.....M-500N 21/2" - 10"
ASSEMBLY.....RPDA.....None.....M-500Z 21/2" - 10"
VACUUM BREAKER.....ASVB.....Pg. 58.....A100 1/2" - 2"
DUAL CHECK.....DC.....Pg. 51.....20 3/4", 1", 11/4"

VALVE TYPES..... BEECO..... WATTS

DETEC to R CHECK.....DCDA.....Pg. 30.....007/U007 1/2" - 3"
VALVE DOUBLE CHECK
ASSEMBLY.....FDC.....Pg. 27 to 34.....709 21/2" - 10"
ASSEMBLY.....FDC.....Pg. 27 to 34.....774 21/2" - 12"
ASSEMBLY.....FDC.....Pg. 25.....719 1/2" - 2"
ASSEMBLY.....FDC.....Pg. 25.....775 1/2" - 2"
ASSEMBLY.....FDC.....Pg. 27 to 34.....757 21/2" - 10"
ASSEMBLY.....FDC.....Pg. 27 to 34.....757N 21/2" - 10"
DOUBLE CHECK.....DCDA.....Pg. 30.....007DCDA 2" - 3"
DETEC to R.....DCDA.....Pg. 30.....709DCDA 3" - 10"
ASSEMBLY.....DCDA.....Pg. 30.....774DCDA 4" - 12"
ASSEMBLY.....DCDA.....Pg. 30.....757DCDA 21/2" - 10"
ASSEMBLY.....DCDA.....None.....757NDCDA 21/2" - 10"
REDUCED.....RPZ.....Pg. 39 to 43.....009 1/4" - 3"
PRESSURE.....RPZ.....Pg. 39 to 43.....909 3/4" - 10"
ZONE.....RPZ.....Pg. 39 to 43.....994 21/2" - 10"
ASSEMBLY.....RPZ.....Pg. 37.....919 1/2" - 2"
ASSEMBLY.....RPZ.....Pg. 39 to 43.....957 21/2" - 10"
ASSEMBLY.....RPZ.....Pg. 39 to 43.....957N 21/2" - 10"
ASSEMBLY.....RPZ.....None.....957Z 21/2" - 10"
REDUCED.....RPDA.....Pg. 42.....909RPDA 21/2" - 10"
PRESSURE.....RPDA.....Pg. 42.....957RPDA 21/2" - 10"
DETEC to R.....RPDA.....Pg. 42.....957NRPDA 21/2" - 10"
ASSEMBLY.....RPDA.....Pg. 42.....957ZRPDA 21/2" - 10"
VACUUM BREAKER.....ASVB.....Pg. 56.....188A 3/4" - 2"
VACUUM BREAKER.....ASVB.....Pg. 56.....288A 1/4" - 3"
DUAL CHECK.....DC.....Pg. 51.....3/8" - 11/4"
VALVES.....DC.....Pg. 51.....07S, 7, Cu7, L7

VALVE TYPES..... BEECO..... CONBRACO

DETEC to R CHECK.....FDC.....Pg. 26.....40-100
VALVE DOUBLE CHECK
VALVE.....FDC.....Pg. 26 to 29.....4S-100 21/2" 6"
DOUBLE CHECK.....DCDA.....Pg. 30.....40-600
DETEC to R.....DCDA.....Pg. 30.....3" - 10"
REDUCED.....RPZ.....Pg. 40 to 50.....40-200
PRESSURE.....RPZ.....Pg. 40 to 50.....1/2" - 10"
RPDA.....RPDA.....Pg. 44.....40-700
RPDA.....RPDA.....Pg. 44.....3" - 10"

VACUUM BREAKER.....ASVB.....Pg. 58.....38-100
VACUUM BREAKER.....ASVB.....Pg. 58.....1/4" - 2"
DUAL CHECK.....DC.....Pg. 51.....40-300
VALVES.....DC.....Pg. 51.....4P-300

VALVE TYPES..... BEECO..... HERSHEY

DOUBLE CHECK.....FDC.....Pg. 27 to 34.....#2 3" - 10"
VALVE.....FDC.....Pg. 27 to 34.....E-1 4" - 6"
ASSEMBLY.....FDC.....Pg. 26.....FDC 3/4" - 2"
ASSEMBLY.....FDC.....Pg. 26.....HDC 3/4" - 2"
ASSEMBLY.....FDC.....Pg. 26.....2
DOUBLE CHECK.....DCDA.....Pg. 30.....DDC-II 3" - 10"
DETEC to R.....DCDA.....Pg. 30.....DDC-II
REDUCED.....RPZ.....Pg. 39.....FRP II 3/4" - 2"
PRESSURE.....RPZ.....Pg. 40 to 50.....6CM 21/2" - 10"
REDUCED.....RPDA.....Pg. 44.....6CMDA
PRESSURE.....RPDA.....Pg. 44.....4" - 10"
DETEC to R.....RPDA.....Pg. 44.....6CM-RPDA

VALVE TYPES..... BEECO..... WILKINS

DOUBLE CHECK.....FDC.....Pg. 26.....950XL/XLU/ XLT/
DOUBLE CHECK.....FDC.....Pg. 26.....950XLUS
DOUBLE CHECK.....FDC.....Pg. 27 to 34.....21/2" - 10"
DOUBLE CHECK.....FDC.....Pg. 27 to 34.....950 21/2" - 10"
DOUBLE CHECK.....FDC.....Pg. 27 to 34.....950DA 21/2" - 10"
DOUBLE CHECK.....FDC.....Pg. 27 to 34.....350 21/2" - 8"
DOUBLE CHECK.....FDC.....Pg. 27 to 34.....450 21/2" - 10"
DOUBLE CHECK.....FDC.....Pg. 27 to 34.....350A/ADA
DOUBLE CHECK.....FDC.....Pg. 27 to 34.....21/2" - 10", 350 3/4" - 1"
DOUBLE CHECK.....DCDA.....Pg. 30.....950DA 21/2" - 10"
DETEC to R.....DCDA.....Pg. 30.....350DA 21/2" - 8"
ASSEMBLY.....DCDA.....Pg. 30.....450DA 4" - 10"
ASSEMBLY.....DCDA.....Pg. 30.....350DA 21/2" - 10"
REDUCED.....RPZ.....Pg. 39.....975XLS 3/4" - 2"
PRESSURE.....RPZ.....Pg. 39.....375
ZONE.....RPZ.....Pg. 39.....475 (N995)
ASSEMBLY.....RPZ.....Pg. 40 to 50.....475V 21/2" - 10"
ASSEMBLY.....RPZ.....Pg. 40 to 50.....375A 21/2" - 10"
ASSEMBLY.....RPZ.....Pg. 40 to 50.....375 21/2" - 10"
REDUCED.....RPDA.....Pg. 44.....975DA 21/2" - 10"
PRESSURE.....RPDA.....Pg. 44.....375DA, 475DA,
DETEC to R.....RPDA.....Pg. 44.....475DAV
ASSEMBLY.....RPDA.....Pg. 44.....375ADA 4" - 8"
VACUUM BREAKER.....ASVB.....Pg. 58.....35
DUAL CHECK.....DC.....Pg. 51.....700

VALVE TYPES..... BEECO..... CLA-VAL

DETEC to R CHECK.....FDC.....Pg. 26 to 34.....D-2
VALVE DOUBLE CHECK
VALVE.....FDC.....Pg. 26 to 34.....D-4
ASSEMBLY.....FDC.....Pg. 26 to 34.....DC6L
ASSEMBLY.....FDC.....Pg. 26 to 34.....DC7L
ASSEMBLY.....FDC.....Pg. 26 to 34.....DC8L
ASSEMBLY.....FDC.....Pg. 26 to 34.....DC8N
ASSEMBLY.....FDC.....Pg. 26 to 34.....DC8V
DETEC to R.....DCDA.....Pg. 30.....DD7L
ASSEMBLY.....DCDA.....Pg. 30.....DD8L
ASSEMBLY.....DCDA.....Pg. 30.....DD8N
REDUCED PRESSURE.....RPZ.....Pg. 40 to 50.....RP-2
REDUCED PRESSURE.....RPZ.....Pg. 40 to 50.....RP-4
REDUCED PRESSURE.....RPZ.....Pg. 40 to 50.....RP-4V
REDUCED PRESSURE.....RPZ.....Pg. 40 to 50.....RP-6L
REDUCED PRESSURE.....RPZ.....Pg. 40 to 50.....RP-7L
REDUCED PRESSURE.....RPZ.....Pg. 40 to 50.....RP-8L
REDUCED PRESSURE.....RPZ.....Pg. 40 to 50.....RP-8N
REDUCED PRESSURE.....RPZ.....Pg. 40 to 50.....RP-8V
DETEC to R.....RPDA.....Pg. 44.....18-4, RD7L

VALVE TYPES..... BEECO..... FLOMATIC

DETEC to R CHECK.....FDC.....Pg. 30.....DCV
VALVE DOUBLE CHECK

REDUCED.....RPZ.....Pg. 40 to 50.....RPZ
PRESSURE.....RPZ.....Pg. 40 to 50.....RPZB
DUAL CHECK.....DC.....Pg. 51.....810
GATE VALVES

BEECO..... AFC

GV.....Pg. 63 to 66.....Series 2500
GV-MJ.....Pg. 63 to 66.....Series 2500
GV-GXG.....Pg. 63 to 66.....N/A

BEECO..... MUELLER

GV.....Pg. 63 to 66.....Series 2300
GV-MJ.....Pg. 63 to 66.....Series 2300
GV-GXG.....Pg. 63 to 66.....N/A

BEECO..... M&H VALVE

GV.....Pg. 63 to 66.....Series 4067
GV-MJ.....Pg. 63 to 66.....Series 4067
GV-GXG.....Pg. 63 to 66.....N/A

BEECO..... KENNEDY

GV.....Pg. 63 to 66.....KS-RW
GV-MJ.....Pg. 63 to 66.....KS-RW
GV-GXG.....Pg. 63 to 66.....N/A
CHECK VALVES.....

BEECO..... AFC

CV.....Pg. 65 to 68.....Fig. 52
CV-WS.....Pg. 65 to 68.....Fig. 52
SCV.....Pg. 65 to 68.....N/A
FCV.....Pg. 65 to 68.....Fig. 2100
WSCV.....Pg. 65 to 68.....N/A
BCV.....Pg. 65 to 68.....N/A

BEECO..... MUELLER

CV.....Pg. 65 to 68.....A-2600
CV-WS.....Pg. 65 to 68.....A-2600
SCV.....Pg. 65 to 68.....N/A
FCV.....Pg. 65 to 68.....Flexible Disc
WSCV.....Pg. 65 to 68.....N/A
BCV.....Pg. 65 to 68.....N/A

BEECO..... APCO

CV.....Pg. 65 to 68.....Series 250
CV-WS.....Pg. 65 to 68.....Series 250
SCV.....Pg. 65 to 68.....Series 600
FCV.....Pg. 65 to 68.....Series 100
WSCV.....Pg. 65 to 68.....Series 300
BCV.....Pg. 65 to 68.....N/A

BEECO..... VALMATIC

CV.....Pg. 65 to 68.....Series 7800
CV-WS.....Pg. 65 to 68.....Series 7800LW
SCV.....Pg. 65 to 68.....Series 1800
FCV.....Pg. 65 to 68.....Series 500A
WSCV.....Pg. 65 to 68.....Series 1400
BCV.....Pg. 65 to 68.....N/A

BEECO..... CRISPIN

CV.....Pg. 65 to 68.....SWC Series
CV-WS.....Pg. 65 to 68.....SWL Series
SCV.....Pg. 65 to 68.....GC Series
FCV.....Pg. 65 to 68.....RF Series
WSCV.....Pg. 65 to 68.....WC Series
BCV.....Pg. 65 to 68.....N/A



Distributed by: **MIFAB**

BEECO FLOMATIC

CV	Pg. 65 to 68	90/92
CV-WS	Pg. 65 to 68	90/92 LW
SCV	Pg. 65 to 68	Series 402
FCV	Pg. 65 to 68	Flow Flex
WSCV	Pg. 65 to 68	Series 888
BCV	Pg. 65 to 68	Series 408

BEECO MILLIKEN

EPV	Pg. 69	Series 601
EPV-MJ	Pg. 69	Series 600

BEECO DEZURIK

EPV	Pg. 69	Series PEF
EPV-MJ	Pg. 69	Series PEF

BEECO VALMATIC

EPV	Pg. 69	Series 5800
EPV-MJ	Pg. 69	Series 5804

CASH ACME

ATMOSPHER- IC VACUUM BREAKERS

CASH ACME BEECO

V100, V100C	Pg. 58	ASVB
-------------------	--------------	------

DOUBLE CHECK BACKFLOW PREVENTERS (LARGE)

CASH ACME BEECO

DCV	Pg. 27 to 34	FDC
-----------	--------------------	-----

DOUBLE CHECK BACKFLOW PREVENTERS (SMALL)

CASH ACME BEECO

DCVE	Pg. 26	FDC
------------	--------------	-----

HOSE CON- NECTION VAC- UUM BREAKERS

CASH ACME BEECO

V3, V3C	Pg. 59	HVB
---------------	--------------	-----

IN LINE DUAL CHECK VALVES

CASH ACME BEECO

BF	Pg. 51	DC
----------	--------------	----

PIPELINE STRAINERS

CASH ACME BEECO

Y-STRAINER	Pg. 59-60	STR
------------------	-----------------	-----

REDUCED PRESSURE ZONE BACK FLOW (LARGE)

CASH ACME BEECO

RPZ	Pg. 40 to 50	FRP-NRS
RPZ	Pg. 40 to 50	FRP-OSY

REDUCED PRESSURE ZONE BACK-FLOW (SMALL)

CASH ACME BEECO

RPZ	Pg. 40	FRP
-----------	--------------	-----

WATER PRESSURE REDUCING VALVES, COMPACT

CASH ACME BEECO

EB-86U	Pg. 11 to 15	PRV-C
EB-87U	Pg. 11 to 15	PRV-C
EB86C	Pg. 11 to 15	PRV-C

CONBRACO

HOSE CON NECTION VAC UUM BREAKERS

CONBRACO BEECO

38-300	Pg. 59	HVB
38-400	Pg. 59	HVB
38-404	Pg. 59	HVB

IN LINE DUAL CHECK VALVES

CONBRACO BEECO

DUC-4N	Pg. 51	DC
--------------	--------------	----

PIPELINE STRAINERS (SMALL)

CONBRACO BEECO

YB, YBS	Pg. 60	STR
---------------	--------------	-----

PIPELINE STRAINERS (LARGE)

CONBRACO BEECO

YSCF	Pg. 59	STR
------------	--------------	-----

REDUCED PRESSURE ZONE BACK FLOW (LARGE)

CONBRACO BEECO

40-200-02	Pg. 40 to 50	FRP-NRS
40-200-03	Pg. 40 to 50	FRP-OSY

REDUCED PRESSURE ZONE BACKFLOW (SMALL)

CONBRACO BEECO

40-200-A2	Pg. 40	FRP
-----------------	--------------	-----

SILENT CHECK VALVES

CONBRACO BEECO

CVB	Pg. 67	CV-IPS
CVBM	Pg. 67	CV-SWT

WATER HEATER THERMAL EXPANSION CONTROL VALVES

CONBRACO BEECO

78-RV SERIES	Pg. 58	MI-CONTROL
--------------------	--------------	------------

WATER PRESSURE REDUCING VALVES, COMPACT

CONBRACO BEECO

36C-U	Pg. 11 to 15	PRV-C
36C-U2T	Pg. 11 to 15	PRV-C
36C-U2S	Pg. 11 to 15	PRV-C
36C	Pg. 11 to 15	PRV-C
36C-US	Pg. 11 to 15	PRV-C

WATTS GROUP, AMES

AU to MATIC CONTROL VALVES

AMES BEECO

6XX	Pg. 2 to 10	ACV
9XX	Pg. 2 to 10	ACV-HF

IN LINE DUAL CHECK VALVES

CONBRACO BEECO

DUC-4N	Pg. 51	DC
--------------	--------------	----

AU TO MATIC CONTROL VALVES (ACV)

ATMOSPHER- IC VACUUM BREAKERS

AMES BEECO

A100	Pg. 58	ASVB
------------	--------------	------

DOUBLE CHECK BACKFLOW PREVENTERS (SMALL)

AMES BEECO

2000SS	Pg. 26	FDC
--------------	--------------	-----

DOUBLE CHECK BACKFLOW PREVENTERS (LARGE)

AMES BEECO

2000, MAXIM, COLT	Pg. 27 to 34	FDC
-------------------------	--------------------	-----

IN LINE DUAL CHECK VALVES

AMES BEECO

20, 20S	Pg. 51	DC
---------------	--------------	----

REDUCED PRESSURE ZONE BACKFLOW (SMALL)

AMES BEECO

4000SS	Pg. 40	FRP
--------------	--------------	-----

REDUCED PRESSURE ZONE BACKFLOW (LARGE)

AMES BEECO

400, 4000, Maxim, Colt	Pg. 27 to 29	FRP-NRS
400, 4000, Maxim, Colt	Pg. 27 to 29	FRP-OSY

WATTS GROUP, FEBCO

ATMOSPHER- IC VACUUM BREAKERS

FEBCO BEECO

710, 715	Pg. 58	ASVB
----------------	--------------	------

DOUBLE CHECK BACKFLOW PREVENTERS (SMALL)

FEBCO BEECO

805Y, 850	Pg. 26	FDC
-----------------	--------------	-----

DOUBLE CHECK DETEC to R ASSEMBLIES

FEBCO BEECO

806YD, 858,856,876V	Pg. 30	FDC-DCDA
---------------------------	--------------	----------



Distributed by: MIFAB

DOUBLE CHECK BACKFLOW PREVENTERS (LARGE)

FE3BCOBEECO

850, 857 Pg. 27 to 34 FDC
 870 Pg. 27 to 34 FDC-NRS
 805YD Pg. 27 to 34 FDC-OSY

WATTS GROUP

GAUGES

WATTSBEECO

DPG1, DPG3, DPG5 Pg. 62-63 PG

GATE VALVES

WATTSBEECO

406 Pg. 63 to 66 GV-NRS
 408 Pg. 63 to 66 GV-OSY

HOSE CONNECTION VACUUM BREAKERS

WATTSBEECO

8 Pg. 69 HVB

IN LINE DUAL CHECK VALVES

WATTSBEECO

7, CU7 Pg. 51 DC

PIPELINE BRONZE STRAINERS

WATTSBEECO

777, 777S Pg. 59 STR

PIPELINE FLANGE IRON STRAINERS

WATTSBEECO

77F, 77CSI Pg. 60 STR

REDUCED PRESSURE ZONE BACKFLOW (LARGE)

WATTSBEECO

774, 775, 709, 770 Pg. 27 to 34 FRP-NRS
 774, 775, 708, 770 Pg. 27 to 34 FRP-OSY

REDUCED PRESSURE ZONE BACKFLOW (SMALL)

WATTSBEECO

909, 009, 995, 919 Pg. 40 to 50 FRP

SILENT CHECK VALVES

WATTSBEECO

600 Pg. 58 CV-IPS
 601, 601S Pg. 58 CV-SWT

THERMAL EXPANSION RELIEF VALVES

WATTSBEECO

BRVS, BRVT, BRVP Pg. 58 MI-CONTROL

WATTS PRESSURE REDUCING VALVES, COMPACT

WATTSBEECO

N35, N45 Pg. 11 to 15 PRV-C

N55, N65 Pg. 11 to 15 PRV-C
 WATTS GROUP
 RPZ BACKFLOW
WATTSBEECO

909, 009, 995, 919 Pg. 40 FRP

SILENT CHECK VALVES

WATTSBEECO

600 Pg. 58 CV-IPS
 601, 601S Pg. 58 CV-SWT

THERMAL EXPANSION RELIEF VALVES

WATTSBEECO

BRVS, BRVT, BRVP Pg. 58 MI-CONTROL

WATTS PRESSURE REDUCING VALVES, COMPACT

WATTSBEECO

N35, N45 Pg. 11 to 15 PRV-C
 N55, N65 Pg. 11 to 15 PRV-C
 WILKINS
REDUCED PRESSURE ZONE BACKFLOW (LARGE)

WILKINSBEECO

975, 375A, 475V, 475 Pg. 40 to 50 FRP-NRS
 975, 375A, 475V, 475 Pg. 40 to 50 FRP-OSY

REDUCED PRESSURE ZONE BACKFLOW (SMALL)

WILKINSBEECO

375, 975XL Pg. 40 FRP

SILENT CHECK VALVES

WILKINSBEECO

40-XL Pg. 58 CV-IPS
 40-XL Pg. 58 CV-SWT

WATTS PRESSURE REDUCING VALVES, COMPACT

WILKINSBEECO

BR4 Pg. 11 to 15 PRV-C
 70, 500 Pg. 11 to 15 PRV-C

CLA-VAL

AU to MATIC CONTROL VALVES

CLA-VAL Pg. 2 to 10 BEECO

DOUBLE CHECK BACKFLOW PREVENTERS (SMALL)

CLA-VALBEECO

DC6L Pg. 26 FDC

DOUBLE CHECK BACKFLOW PREVENTERS (LARGE)

CLA-VALBEECO

DC8N Pg. 30 to 40 FDC
 D-4, DC7-L, DC8L Pg. 30 to 40 FDC-NRS
 D-4, DC7-L, DC8L Pg. 30 to 40 FDC-OSY

DOUBLE CHECK DETEC to R ASSEMBLIES

CLA-VALBEECO

DD7L, DD8L, 16-4 Pg.30 FDC-DCDA

REDUCED PRESSURE ZONE BACKFLOW (SMALL)

CLA-VALBEECO

RP-2, RP-6L Pg. 40 FRP

REDUCED PRESSURE ZONE BACKFLOW (LARGE)

CLA-VALBEECO

RP-4, RP-7L, RP8L Pg.40 to 50 FRP-NRS

CONBRACO

ATMOSPHERIC VACUUM BREAKERS

CONBRACOBEECO

38-100 Pg. 58 ASVB

BRONZE BALL VALVES

CONBRACOBEECO

32-100 Pg. 60-61 BV-IPS-BRONZE
 32-200 Pg. 60-61 BV-SWT-BRONZE

DOUBLE CHECK BACKFLOW PREVENTERS (LARGE)

CONBRACOBEECO

4S-100 Pg. 27 to 34 FDC
 4S-100-02 Pg. 27 to 34 FDC-NRS
 4S-100-03 Pg. 27 to 34 FDC-OSY

DOUBLE CHECK BACKFLOW PREVENTERS (SMALL)

CONBRACOBEECO

40-100 Pg. 26 FDC

DOUBLE CHECK DETEC to R ASSEMBLIES

CONBRACOBEECO

46, 4SG Pg. 30 FDC-DCDA

WATTS GROUP, FLOWMATIC

ATMOSPHERIC VACUUM BREAKERS

FLOWMATICBEECO

AVB Pg. 58 ASVB

AU to MATIC CONTROL VALVES

FLOWMATICBEECO

MODEL C Pg. 2 to 10 ACV

HOSE CONNECTION VACUUM BREAKERS

FLOWMATICBEECO

HB8 Pg. 59 HVB

DOUBLE CHECK BACKFLOW PREVENTERS (LARGE) ..

FLOWMATICBEECO

DCV (Pg. 27 to 34 FDC



Distributed by: **MIFAB**

DOUBLE CHECK BACKFLOW PREVENTERS (SMALL)

FLOWMATIC BEECO
 DCVE.....Pg.26.....FDC

IN LINE DUAL CHECK VALVES

FLOWMATIC BEECO
 8080E.....Pg. 51.....DC

REDUCED PRESSURE ZONE BACKFLOW (LARGE)

FLOWMATIC BEECO
 RPZPg. 40 to 50.....FRP-NRS
 RPZPg. 40 to 50.....FRP-OSY

REDUCED PRESSURE ZONE BACKFLOW (SMALL)

FLOWMATIC BEECO
 RPZPg. 40.....FRP
 RPZ II.....Pg. 40.....FRP

HERSEY

DOUBLE CHECK BACKFLOW PREVENTERS (SMALL)

HERSEY BEECO
 DCPg. 26.....FDC
 FDCPg. 26.....FDC

DOUBLE CHECK BACKFLOW PREVENTERS (LARGE)

HERSEY BEECO
 #2.....Pg. 27 to 34.....FDC
 FDCPg. 27 to 34.....FDC
 HDC.....Pg. 27 to 34.....HDC

REDUCED PRESSURE ZONE BACKFLOW (SMALL)

HERSEY BEECO
 FRP I, FRP II.....Pg. 40.....FRP
 #6, #10, #12, #14.....Pg. 40.....FRP

REDUCED PRESSURE ZONE BACKFLOW (LARGE)

HERSEY BEECO
 6-C.....Pg. 40 to 50.....FRP
 6-CM.....Pg. 40 to 50.....FRP

WATTS GROUP, FEBCO

HOSE CONNECTION VACUUM BREAKERS

FEBCO BEECO
 731.....Pg. 59.....HVB
 731-FR.....Pg. 59.....HVB-FR

IN LINE DUAL CHECK VALVES

FEBCO BEECO
 510.....Pg. 51.....DC

REDUCED PRESSURE ZONE BACKFLOW (SMALL)

FEBCO BEECO
 825Y, 860.....Pg. 40.....FRP

REDUCED PRESSURE ZONE BACKFLOW (LARGE)

FEBCO BEECO
 8,60,867.....Pg. 40 to 50.....FRP-NRS
 880,825YD, 880V.....Pg. 40 to 50.....FRP-OSY

WATTS

ATMOSPHERIC VACUUM BREAKERS

WATTS..... BEECO
 288A.....Pg. 58.....ASVB

AU to MATIC CONTROL VALVES

WATTS..... BEECO
 110, 113, 115, 116.....Pg. 2-10.....ACV

BRONZE BALL VALVES

WATTS..... BEECO
 B6000.....Pg. 60 to 61.....BV-IPS-BRONZE
 B6001.....Pg. 60 to 61.....BV-SWT-BRONZE

DIELECTRIC UNIONS

WATTS..... BEECO
 3001A, 301, 3003.....Pg. 69.....DU

DOUBLE CHECK BACKFLOW PREVENTERS (LARGE)

WATTS..... BEECO
 774, 775, 709, 770.....Pg. 27 to 34.....FDC

DOUBLE CHECK BACKFLOW PREVENTERS (SMALL)

WATTS..... BEECO
 007, 775, 719.....Pg. 26.....FDC

DOUBLE CHECK DETEC to R ASSEMBLIES

WATTS..... BEECO
 007DCDA, 709DCDA.....Pg. 30.....FDC-DCDA
 774DCDA, 757DCDA.....Pg. 30.....FDC-DCDA

WILKINS

ATMOSPHERIC VACUUM BREAKERS

WILKINS..... BEECO
 740.....Pg. 58.....ASVB

AU to MATIC CONTROL VALVES

WILKINS..... BEECO
 ZW105, ZW106, ZW109.....Pg. 2 to 10.....ACV
 ZW169.....Pg. 2 to 10.....ACV

BRONZE BALL VALVES

WILKINS..... BEECO
 850.....Pg. 60-61.....BV-IPS- BRONZE

DIELECTRIC UNIONS

WILKINS..... BEECO
 DU,DUC, DUM.....Pg. 69.....DU

DOUBLE CHECK BACKFLOW PREVENTERS (LARGE)

WILKINS..... BEECO
 35,04,50,950.....Pg. 27 to 34.....FDC

DOUBLE CHECK BACKFLOW PREVENTERS (SMALL)

WILKINS..... BEECO
 350, 950.....Pg. 26.....FDC

DOUBLE CHECK DETEC to R ASSEMBLIES

WILKINS..... BEECO
 350DA, 450DA, 950DA.....Pg. 30.....FDC-DCDA

GATE VALVES

WILKINS..... BEECO
 48.....Pg. 63 to 66.....GV-NRS
 48OSY.....Pg. 63 to 66.....GV-OSY
 GAUGES.....

WILKINS..... BEECO

HGI-25, 92-25.....Pg. 62 to 63.....PG

HOSE CONNECTION VACUUM BREAKERS ...

WILKINS..... BEECO
 BFP-9.....Pg. 59.....HVB

IN LINE DUAL CHECK VALVES

WILKINS..... BEECO
 705.....Pg. 51.....DC

PIPELINE BRONZE STRAINERS

WILKINS..... BEECO
 YB, S.....Pg. 60.....STR

PIPELINE FLANGED IRON STRAINERS

WILKINS..... BEECO
 FS.....Pg. 59.....STR



ABBREVIATIONS

BEECO-2019-07

Distributed by: MIFAB®

Beeco Part Numbers. First set of letters Abbreviation for Valve followed by pipe size .75 = 3/4" 6 = 6" Followed by the following major features.

ACV (AUTOMATIC CONTROL VALVES)

- A..... Angle body design
- AL..... Altitude control valve (1 way flow)
- AL-BD..... Altitude control valve (2 way flow)
- BASIC..... Basic valve no pilot
- BC..... Pump control valve
- CV..... Check valve or check feature
- DW..... Deep well pump control valve
- EC..... Electric control (regulating) valve
- EL..... Electric (on/off) valve or feature
- EL..... (On-off) valve or feature
- EL-RFP..... Electric flood protection shut-down valve
- FE..... Excess flow shut-off valve
- FL..... Level control (modulating) valve
- FLDI1..... Level control (on-off) valve or feature
- FLEL..... Level control (electric on-off) valve
- FR..... Flow rate control valve
- HF..... High flow
- HP..... High pressure 300# valve
- HP..... High pressure (ANSI 300)
- PI..... Position indicator
- PR..... Pressure reducing valve or feature
- PR..... Pressure reducing
- PREL..... Pressure reducing / electric (on-off)
- PS..... Pressure sustaining
- PS..... Pressure sustaining
- PSDI..... Differential sustaining valve or feature
- PSEL..... Pressure sustaining / electric (on-off)
- PSR..... Pressure sustaining/relief valve or feature
- Q..... Quick closing feature
- QR..... Quick relief valve or feature
- RE..... Hydraulic surge anticipator valve
- REEL..... Electric surge anticipator valve
- SSV..... High pressure safety shut-down valve
- UL..... Underwriters laboratory approved

PRV (PRESSURE REDUCING VALVES)

- C..... Compact model
- CPVC..... Plastic connections
- DU..... Double unions
- F..... Full model (separate strainer cavity)
- IPS..... Internal pipe system (same as NPT)
- JK..... Jumper kit
- LL..... Low lead (ab 1953 compliant)
- PEX..... Pex connections
- SU..... Single union
- SWT..... Copper sweat fitting
- UK..... Union kit

FRP (FRIENDLY REDUCED PRESSURE BACKFLOW PREVENTERS)

- BA..... Buy america
- DCDA..... Double check detector assembly
- G..... Grooved end connections
- LF..... Less fittings (no ball valves attached)
- LH..... Locking handles on ball valves

- LL..... Low lead (ab 1953 compliant)
- NRS..... Non rising stem gate valve
- OSY..... Outside stem and yoke gate valve
- QT..... Quarter turn ball valves as shutoffs
- RPDA..... Reduced pressure detector assembly
- S..... Strainer attached
- SH..... Stainless handles on ball valves

PRB (PRESSURE VACUUM BREAKERS)

- LL..... Low lead (ab 1953 compliant)
- QT..... Quarter turn ball valves as shutoffs

DC (DOUBLE CHECK (IN LINE))

- FWM..... Female water meter
- LL..... Low lead
- NPT..... National pipe thread
- SWT..... Copper sweat fitting

AG

- AG..... Air Gap

GV (GATE VALVES)

- FM..... Factory mutual approved
- FXF..... Flanged by flanged
- FXG..... Flanged by grooved
- GXG..... Grooved by grooved
- MJ..... Mechanical joint
- NRS..... Non rising stem gate valve
- OSY..... Outside stem and yoke gate valve
- UL..... Underwriters laboratory approved

CV (CHECK VALVES)

- IPS..... Internal pipe system (same as NPT)
- LL..... Low lead (ab1953 compliant)
- RD..... Rubber disc
- SWT..... Copper sweat fitting
- WS..... Weight and spring

ASVB (ANTI-SIPHON VACUUM BREAKERS)

- B..... Brass finish
- CP..... Chrome plated finish
- LL..... Low lead (ab 1953 compliant)

ASVB (ANTI-SIPHON VACUUM BREAKERS)

- B..... Brass finish
- CP..... Chrome plated finish
- LL..... Low lead (ab 1953 compliant)

HVB (HOSE VACUUM BREAKERS)

- CP..... Chrome plated finish
- LL..... Low lead
- RB..... Rough brass finish

DU (DIELECTRIC UNIONS)

- IPS..... Internal pipe system (same as NPT)
- LL..... Low lead
- SWT..... Copper sweat fitting

EPV (ECCENTRIC PLUG VALVES)

- FLG..... Flanged (ANSI 150)
- MJ..... Mechanical joint

STR (STRAINERS)

- BRZ..... Bronze material (C84400)
- FLG..... Flanged
- IPS..... Internal pipe system (same as NPT)
- LL..... Low lead
- PC..... Epoxy coated
- SWT..... Copper sweat fitting

BV (BALL VALVES)

- BRZ..... Bronze material (C84400)
- IPS..... Internal pipe system (same as NPT)
- LH..... Locking handles on ball valves
- LL..... Low lead (ab 1953 compliant)
- SH..... Stainless handles on ball valves
- SWT..... Copper sweat fitting

PG (PRESSURE GAUGES)

- BK..... Back port
- BTM..... Bottom port
- T..... Top port

AV (AIR VENTS)

- FL..... Flanged (ANSI 150)
- HP..... High pressure (ANSI 300)
- K..... Air & vacuum
- KA..... Combination air release and air & vacuum
- MH..... Full port
- MS..... Reduced port
- P..... Plastic
- SA..... Surge arresting feature
- SS..... Stainless steel
- TH..... IPS threaded
- WP..... Wastewater



Distributed by: MIFAB®

TERMS AND CONDITIONS

BEECO-2019-07

WHOLESALE DISCOUNT: Contact BEECO® or your local representative for your applicable discount structure.

FREIGHT ALLOWANCE: Ex Works, BEECO's Chicago, Illinois Factory or Manufacturer Representative's warehouse with full motor freight allowed on shipments of \$2,500 Net or more, within the continental U.S.A. or Canada, except Alaska, Hawaii and Puerto Rico. BEECO® reserves the right to choose the carrier and route of shipment. Alaska: Ex Works, Seattle, WA. Hawaii: Freight allowed on shipments of \$3,500 or more only when shipped from West Coast, U.S. Puerto Rico: Ex Works, Miami, Florida. There is no allowance for United Parcel Service, Federal Express or Shipment by air service. Full motor freight is allowed on shipments of \$3,500 Net or more, within the continental U.S.A. and Canada for any combination of BEECO, Counterline, No Hub Coupling, Trench Drain, Access Door and Trap Seal Primer products. Shipping dates are estimates and time of delivery is not the essence of the sale of the contract. Therefore, under no circumstances will BEECO have any responsibility on account of any delays in manufacture, transportation, or otherwise. Additional freight services such as construction site delivery, lift gate delivery service, re-consigned freight or notification charges, are not included in full freight allowance terms, and will result in additional freight charges.

QUOTATION TERMS: List Price and discount protected for 30 days from date issued by BEECO®. Orders received within this period must be released for shipment within 30 days from date of purchase order, otherwise, prices will be those that are in effect at the time of shipment.

PAYMENT TERMS: Terms of payment are Net 30 days from the date of the invoice. All pricing in United States currency unless sold in Canada in which case Canadian dollars is the currency used. The Buyer shall pay all sales, consumers, and / or any other applicable taxes. Past due accounts will be subject to a 2% per month service charge from the date of the invoice. If any proceedings be instructed by or against Buyer under any bankruptcy or insolvency law, or if Buyer shall fail to make timely payment on this or any other order, or if, in MIFAB's judgment, Buyer's financial situation justifies such action, BEECO® may, at its election, require payment in advance or cancel the order as to any unshipped item and require payment of its reasonable cancellation charges. If Buyer delays completion of manufacture, BEECO® may elect to require payment according to percentage of completion. Equipment held for Buyer shall be at Buyer's risk and expense. In all cases, regardless of partial payment, title to the Products shall remain with BEECO® until payment for the Products (including any notes given therefore) has been made in full. Should legal action be necessary to enforce payment of an unpaid invoice, the Buyer will assume full responsibility for any court costs and reasonable attorney fees. All orders subject to credit check and approval prior to shipment. Confirmed irrevocable letter of credit or cash in advance of shipment is required for accounts without an established line of credit. Minimum invoice amount is \$100. BEECO reserves the right to apply a minimum order charge to equal \$100. BEECO's Accounting Department must be notified of potential pricing errors within 30 days of the invoice date. Any terms and conditions stated on Buyer's orders which are inconsistent with MIFAB's quotation and Terms and Warranties shall be of no effect.

RETURNED GOODS RESTOCKING CHARGE: Standard product may be returned within a one year period only with written permission from BEECO®. All products in catalog are not considered Standard. Standard product to be determined by BEECO®. Returned goods are subject to a 25% restocking charge, plus cost of reconditioning, if necessary, to make material saleable. Material must be returned to BEECO® freight prepaid only after written permission from BEECO® to accept the returned material. Buyer must provide copy of the original invoice on which the material was charged. The original outgoing freight cost to ship the order will be deducted from the credit. Credit allowance will be in the form of merchandise credit only-not cash credit which must be used within 12 months of the date of issue. The value of a return must total \$100 to qualify for credit allowance. Products designated non stock and / or that have been specially made (require a sign off drawing by BEECO®) are not subject to return or cancellation.

LIMITED WARRANTY: BEECO® warrants each product against defects in material and workmanship for a period of one year from the date of original shipment. In the event of such defects within the warranty period, BEECO® will, at its option, replace or recondition the product without charge. This shall constitute the exclusive remedy for breach of warranty, and BEECO® shall not be responsible for any incidental or consequential damages, including, without limitation, damages or other costs resulting from labor charges, delays, vandalism, negligence, fouling caused by foreign material, damage from adverse water conditions, chemicals, or any other circumstances over which BEECO® has no control. This warranty shall be invalidated by any abuse, misuse, misapplication or improper installation of the product. For inoperative products beyond the warranty period, we assume no liability for replacement of valves due to service conditions beyond our control. Consult local codes and specifications and have a qualified licensed professional install all BEECO® devices.

BEECO® MAKES NO OTHER WARRANTIES EXPRESSED OR IMPLIED AS PROVIDED IN THIS LIMITED WARRANTY.

ILLUSTRATIONS OR TYPICAL INSTALLATIONS: The typical installations for various products in each product section are intended to illustrate the products and their options. Under no circumstances are they to be construed as recommended installation procedures. Consult local codes and project specifications for proper installation instructions.

ALL SALES SUBJECT TO BEECO's TERMS AND WARRANTIES.

NOTE: Prices and terms are subject to change without notice and supersede all previous quotations. The right is reserved to change or modify product design or construction without prior notice and without incurring any obligation to make similar changes and modifications to product previously or subsequently sold. Contact BEECO® for any clarification.

CONTENTS © BEECO® INC. Copyright 2019

MIFAB® BINDER AND PRICE BOOKS



COMPLETE MIFAB BINDER
(with all product booklets inside)
Lit # 001B



MPB-2019-USA
Lit # 067



NH-2019
Lit # 044



CLPB-2019
Lit # 048



BEECO-2019-07
Lit # 071



AD-2017-USA
Lit # 043



TSP-2017
Lit # 062



TD-2017
Lit # 046



TDSS-2016
Lit # 072



ACV
Lit # 059



DB-2018
Lit # 070



CPORT-2019
Lit # 047



INT-2019
Lit # 095



HYDROMAX-2019
Lit # 082



FILCOTEN-2017
Lit # 076



ROOFGUARD-2018
Lit # 058

Design and dimensions are subject to modification. Prices do not include applicable taxes.

Visit www.beecobackflow.com for the most recent product information.

BEECO, Inc., 1321 West 119th Street, Chicago, Illinois 60643-5109, USA
All sales subject to BEECO's Terms and Warranties. Please refer to page no. 64.

Toll Free: 1-800-465-2736, Fax: 1-773-341-3049
sales@mifab.com • Canada Toll Free: 1-800-387-3880

- Backflow Preventers
- Pressure Reducing Valves
- Automatic Control Valves
- Gate Valves
- Strainers
- Gauges

- Ball Valves
- Dielectric Unions
- Pressure Vacuum Breakers
- In Line Double Check Valves
- Anti-Siphon Vacuum Breakers
- Air Vents

“Beeco has a competitive Backflow device that is good for my market, the Beeco repair kits are very economical to purchase.”

- Mark Griffin, Mag Industries Australia

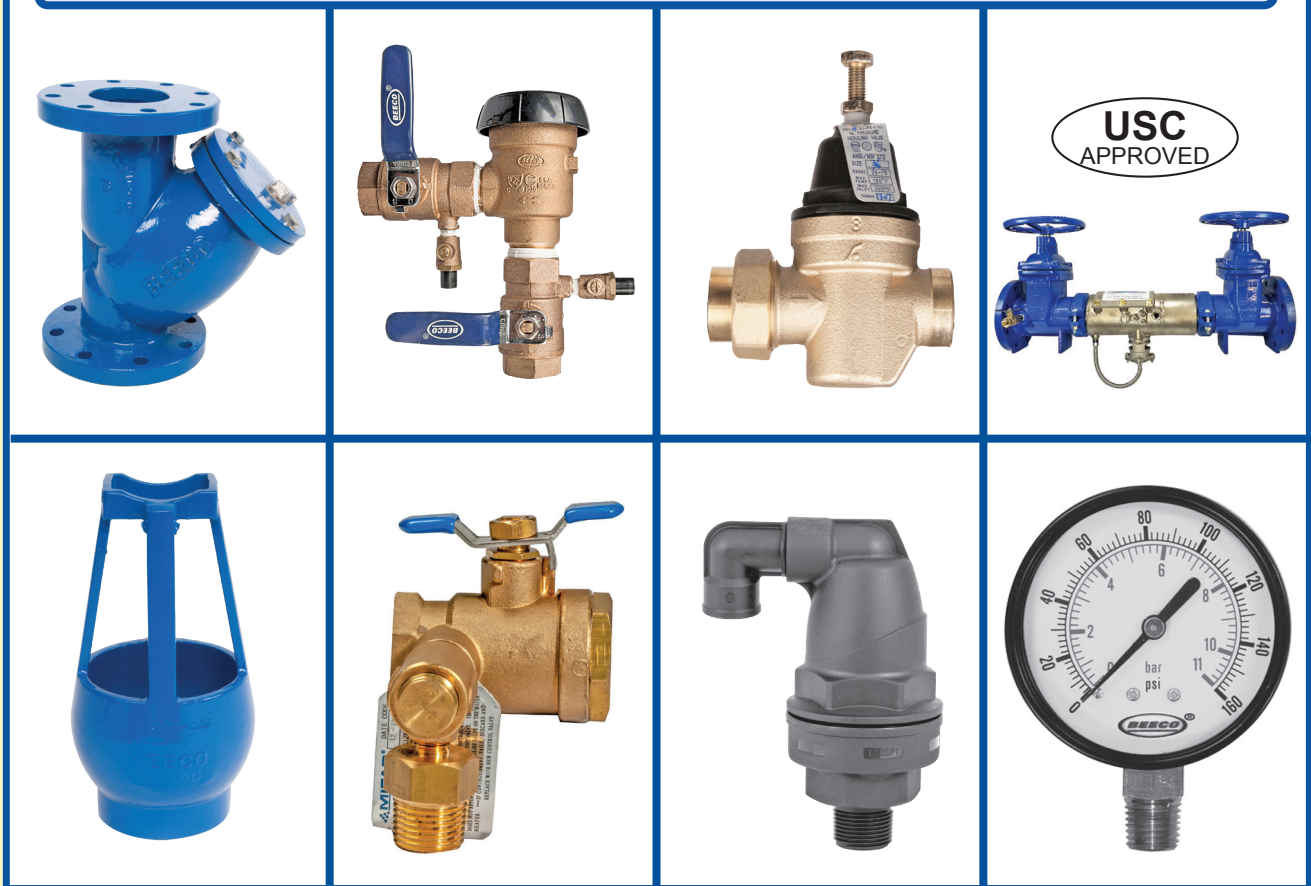

Download this catalog to your digital device.

Backflow Preventers & Accessories

LIT-071

